



US00D651106S

(12) **United States Design Patent**
Bradford et al.

(10) **Patent No.:** **US D651,106 S**
(45) **Date of Patent:** **** *Dec. 27, 2011**

(54) **CYTOMETER**

(75) Inventors: **Jolene Ann Bradford**, Eugene, OR (US); **Gregory Kaduchak**, Eugene, OR (US); **Michael Wayne Olszowy**, Eugene, OR (US); **Michael Dennis Ward**, Eugene, OR (US); **William Lunt Godfrey**, Coral Gables, FL (US); **Jan Zwierstra**, San Pedro, CA (US); **Sean Michael Cole**, Denver, CO (US); **Cody Collier Henderson**, Denver, CO (US); **James Kolozs**, Denver, CO (US); **Ian Bradley Thorne**, Thornton, CO (US); **Phillip Nolan Tyler**, Westminster, CO (US); **Robin Carlton Swain**, Trabuco Canyon, CA (US); **David Anton Van Gogh**, Los Angeles, CA (US)

(73) Assignee: **Life Technologies Corporation**, Carlsbad, CA (US)

(**) Term: **14 Years**

(21) Appl. No.: **29/360,863**

(22) Filed: **Apr. 30, 2010**

Related U.S. Application Data

(63) Continuation of application No. 29/360,863, filed on Apr. 30, 2010.

(51) **LOC (9) Cl.** **10-04**

(52) **U.S. Cl.** **D10/97**

(58) **Field of Classification Search** D10/97;
D24/216, 232-234; 250/458.1; 356/30,
356/38, 39, 72, 73, 121, 246, 317, 318, 336,
356/340, 343, 621; 378/44; 422/73, 82.09;
436/53, 165; 600/309; 604/5.01; 701/1

See application file for complete search history.

(56) **References Cited**

U.S. PATENT DOCUMENTS

D357,199 S 4/1995 Peltola

(Continued)

OTHER PUBLICATIONS

Beckman Coulter, Flow Cytometry the lifeblood of research (3 pages).

(Continued)

Primary Examiner — Antoine D Davis

(57) **CLAIM**

The ornamental design for a cytometer, as shown and described.

DESCRIPTION

FIG. 1 is a front perspective view of a first embodiment of a cytometer of our new design.

FIG. 2 is a front view of the cytometer of FIG. 1.

FIG. 3 is a back view of the cytometer of FIG. 1.

FIG. 4 is a right side view of the cytometer of FIG. 1.

FIG. 5 is a left side view of the cytometer of FIG. 1.

FIG. 6 is a top view of the cytometer of FIG. 1.

FIG. 7 is a bottom view of the cytometer of FIG. 1.

FIG. 8 is a front perspective view of a second embodiment of a cytometer of our new design.

FIG. 9 is a front view of the cytometer of FIG. 8.

FIG. 10 is a back view of the cytometer of FIG. 8.

FIG. 11 is a right side view of the cytometer of FIG. 8.

FIG. 12 is a left side view of the cytometer of FIG. 8.

FIG. 13 is a top view of the cytometer of FIG. 8.

FIG. 14 is a bottom view of the cytometer of FIG. 8.

FIG. 15 is a front perspective view of a third embodiment of a cytometer of our new design.

FIG. 16 is a front view of the cytometer of FIG. 15.

FIG. 17 is a back view of the cytometer of FIG. 15.

FIG. 18 is a right side view of the cytometer of FIG. 15.

FIG. 19 is a left side view of the cytometer of FIG. 15.

FIG. 20 is a top view of the cytometer of FIG. 15.

FIG. 21 is a bottom view of the cytometer of FIG. 15.

FIG. 22 is a front perspective view of a fourth embodiment of a cytometer of our new design.

FIG. 23 is a front view of the cytometer of FIG. 22.

FIG. 24 is a back view of the cytometer of FIG. 22.

FIG. 25 is a right side view of the cytometer of FIG. 22.

FIG. 26 is a left side view of the cytometer of FIG. 22.

FIG. 27 is a top view of the cytometer of FIG. 22; and,

FIG. 28 is a bottom view of the cytometer of FIG. 22.

The bottom view of our design and the portions depicted in broken lines are not part of the claimed design.

1 Claim, 16 Drawing Sheets

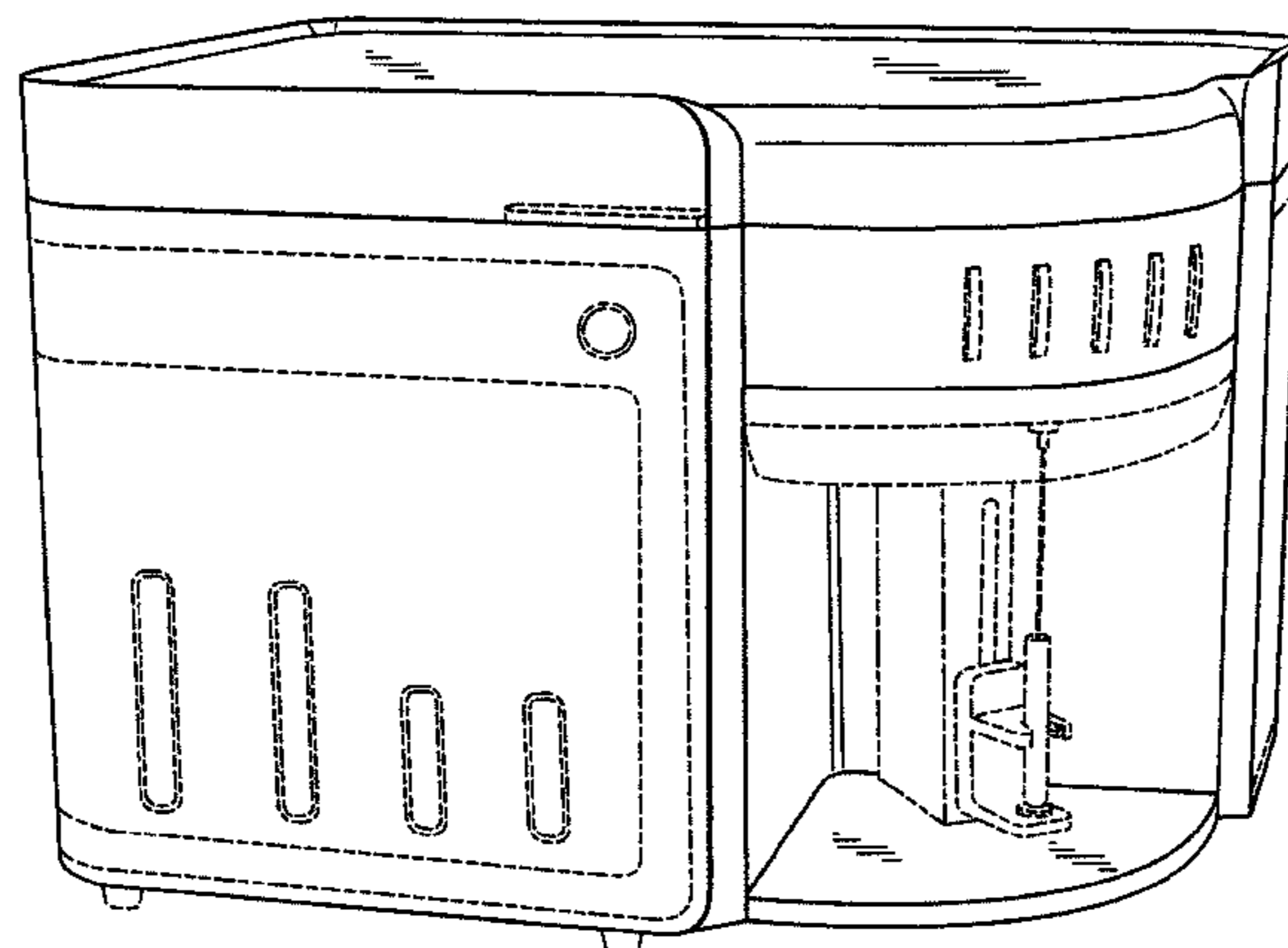

U.S. PATENT DOCUMENTS

D552,500 S *	10/2007	Forslund	D10/97
D601,051 S	9/2009	Coumans et al.		
2011/0076755 A1*	3/2011	Ebi et al.	435/287.3
2011/0176934 A1*	7/2011	Ebi et al.	417/44.1

OTHER PUBLICATIONS

Millipore, Guava Technologies, Guava® EasyCytea™ Mini Flow Cytometry System (4 pages).

BD FACSCanto™ Flow Cytometer (12 pages).

Millipore™, Flow Cytometry—Instruments (6 pages).

Unbranded website, “From Chaos Comes Order, The Future of Cellular Analysis is Acoustic Focusing Cytometry,” [website page online], Nov. 20, 2009, p. 1. Retrieved from the Internet: <Fromchaostorder.com>.

Instrument picture shown in trailer video on Fromchaostorder.com, Nov. 20, 2009.

Applied Biosystems branded website, “Flow Cytometry,” with video “Introducing the Attune™ Focusing Cytometer,” [website page

online], Nov. 20, 2009: pp. 1-2, [retrieved on Jun. 17, 2011]. Retrieved from the Internet: <<http://www.appliedbiosystems.com/absite/us/en/home/applications-technologies/flow-cytometry.html>>. Prelaunch Brochure. Attune™ Acoustic Focusing Cytometer, “From Chaos comes Order. From inspiration comes breakthrough. Introducing the Attune™ Acoustic Focusing Cytometer,” Nov. 20, 2009.

Ward, Michael et al., “Fundamentals of Acoustic Cytometry,” Current Protocols in Cytometry, Jul. 2009, unit 1.22.1-1.22-1, Supplement 49, published online in Wiley Interscience <www.interscience.wiley.com>.

Applied Biosystems branded website, “Flow Cytometry,” with video “Debut of the Attune™ Cytometer at ASCB,” [website page online], Dec. 5, 2009, pp. 1-2, [retrieved on Jun. 17, 2011]. Retrieved from the Internet: <<http://www.appliedbiosystems.com/absite/us/en/home/applications-technologies/flow-cytometry.html>>.

Picture of T-shirt distributed at the American Society for Cell Biology meeting on Dec. 7, 2009.

Pictures posted on Odyssey, Inc’s. website on Apr. 1, 2010.

* cited by examiner

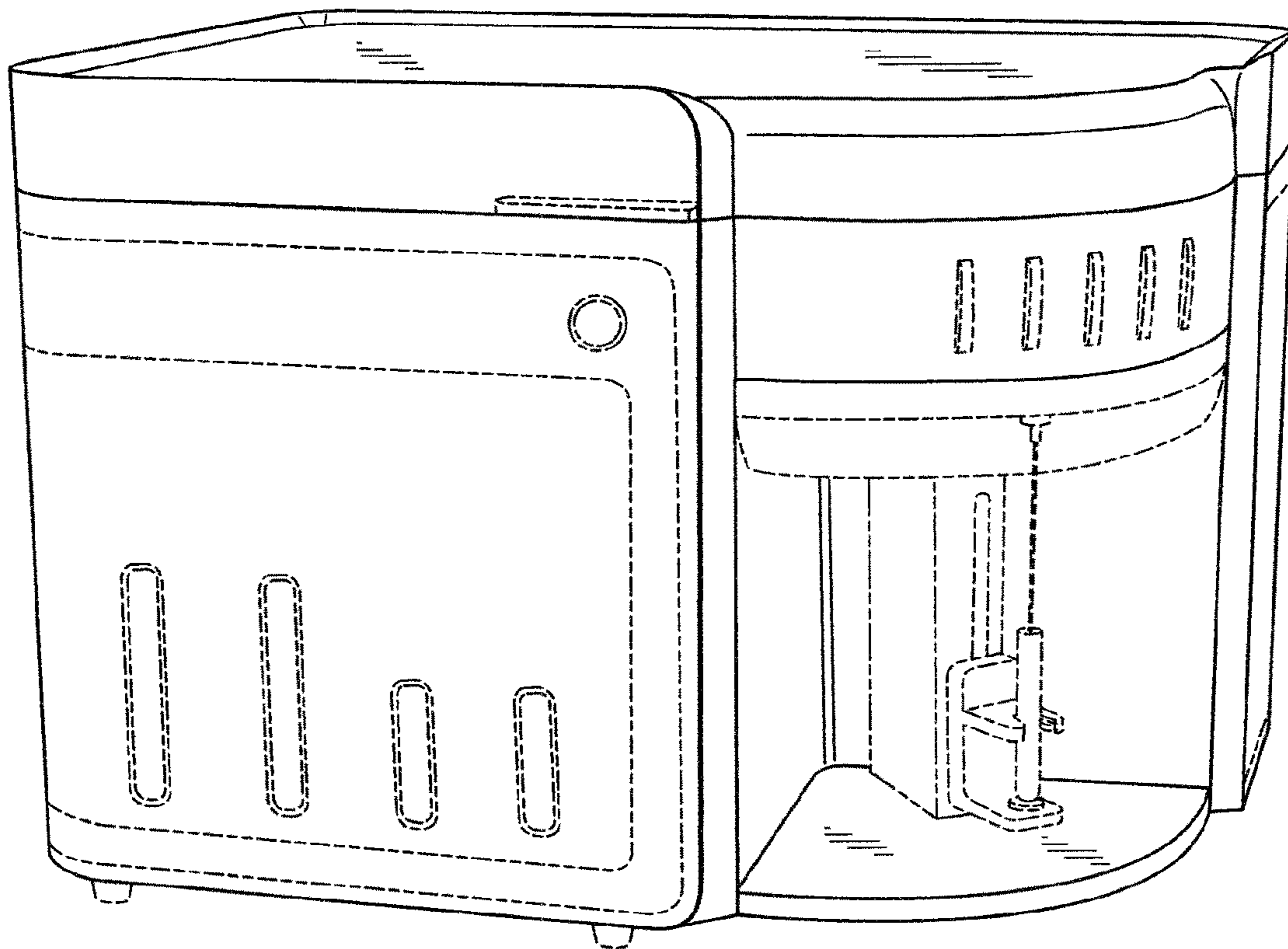

Figure 1

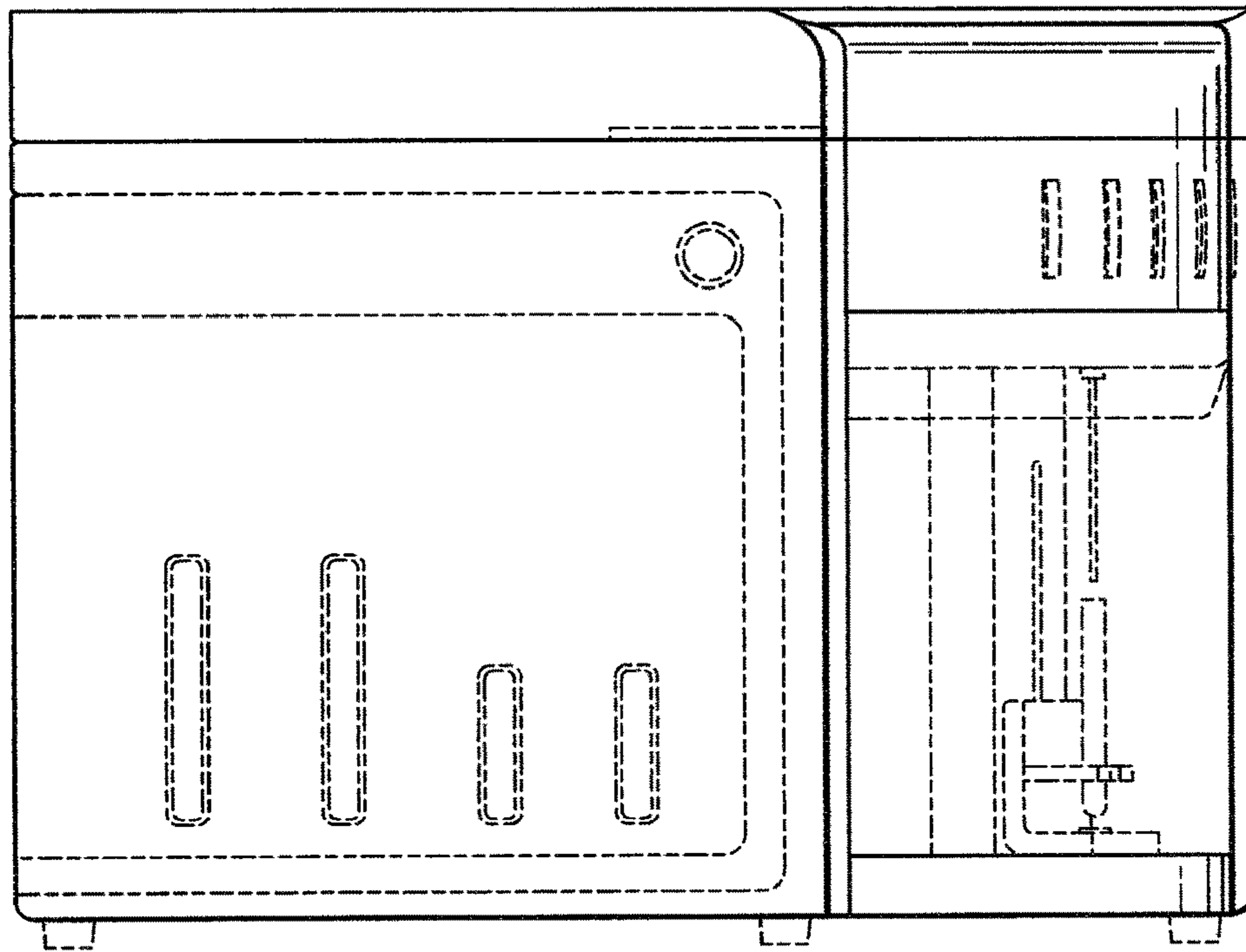

Figure 2

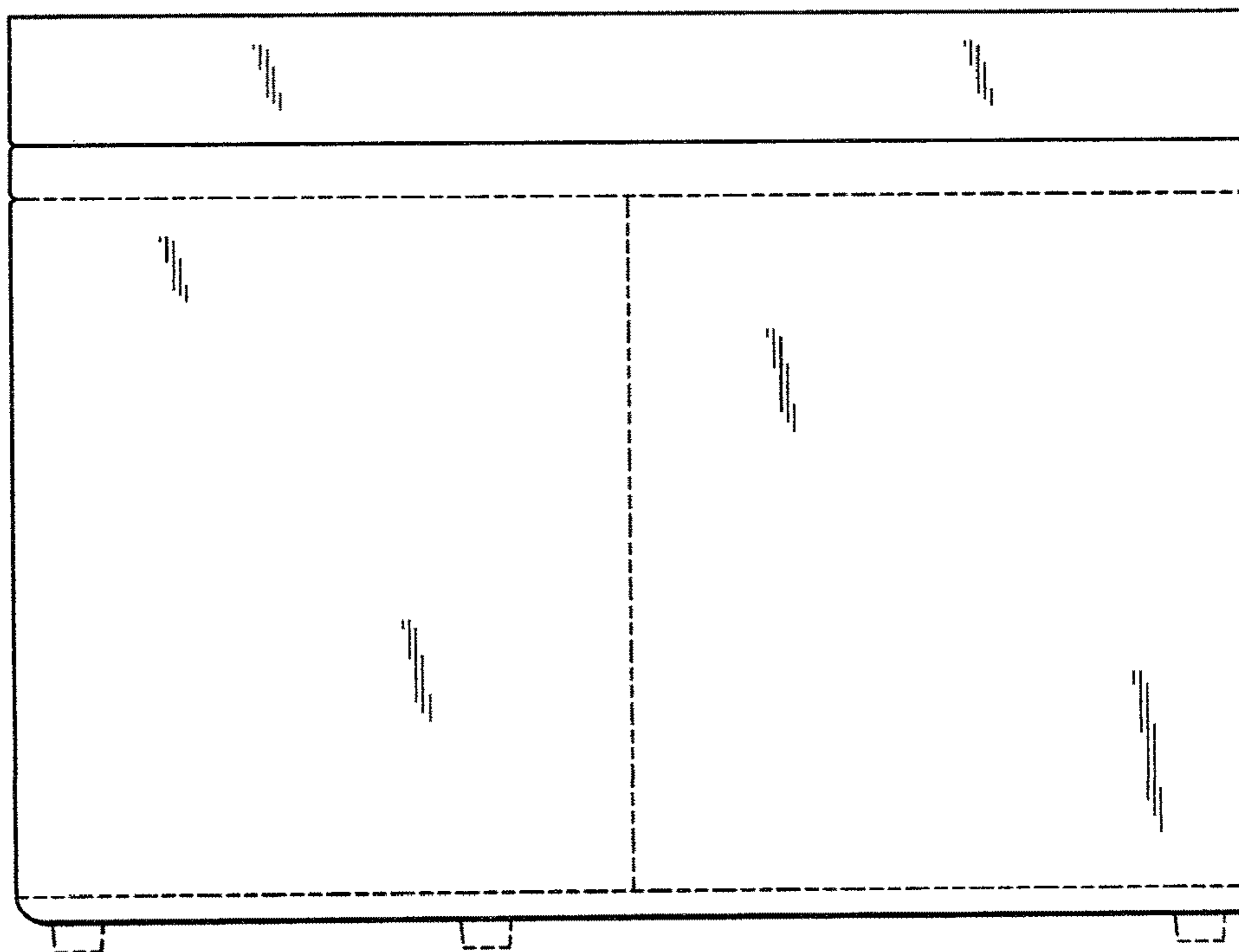

Figure 3

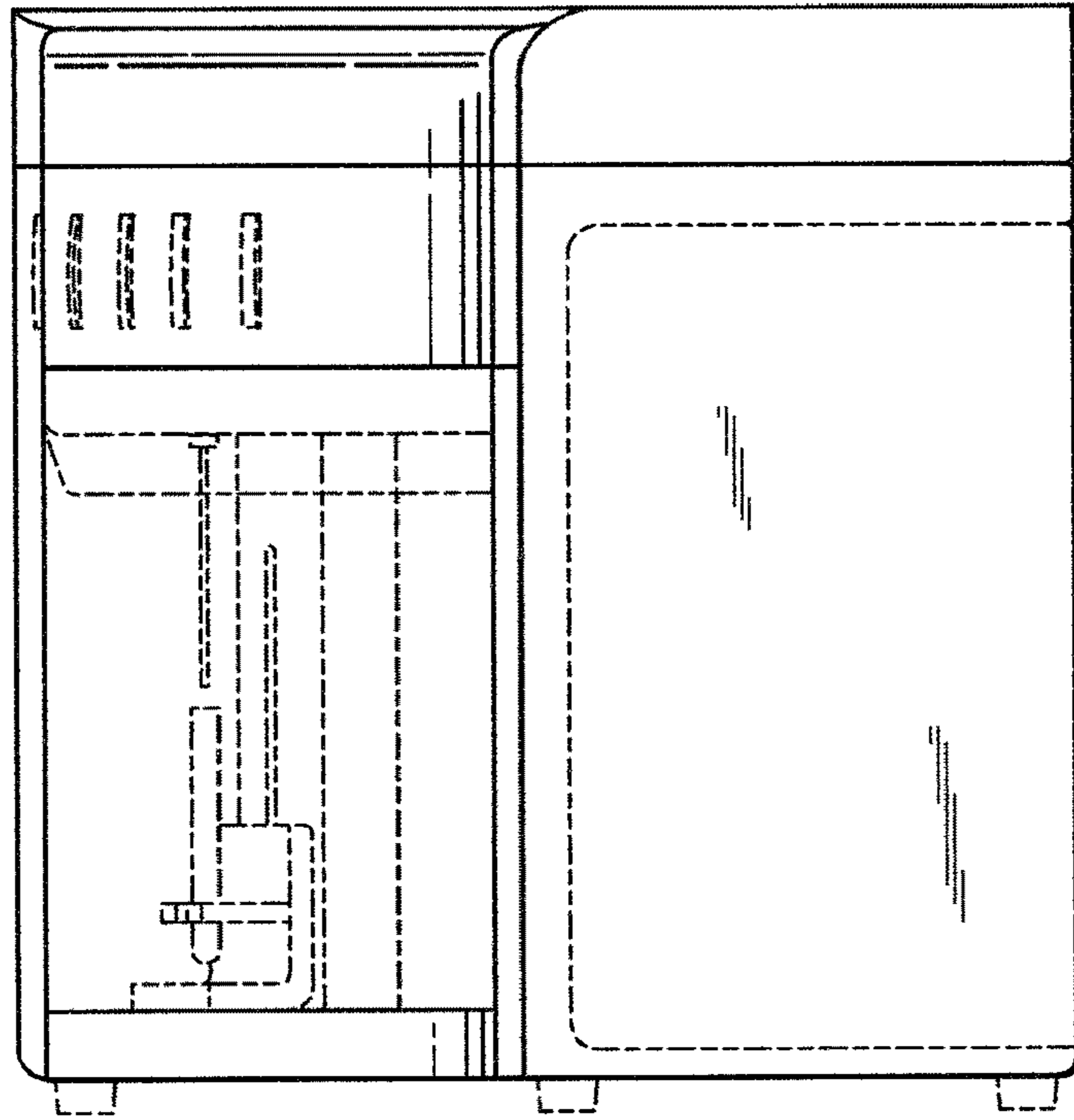

Figure 4

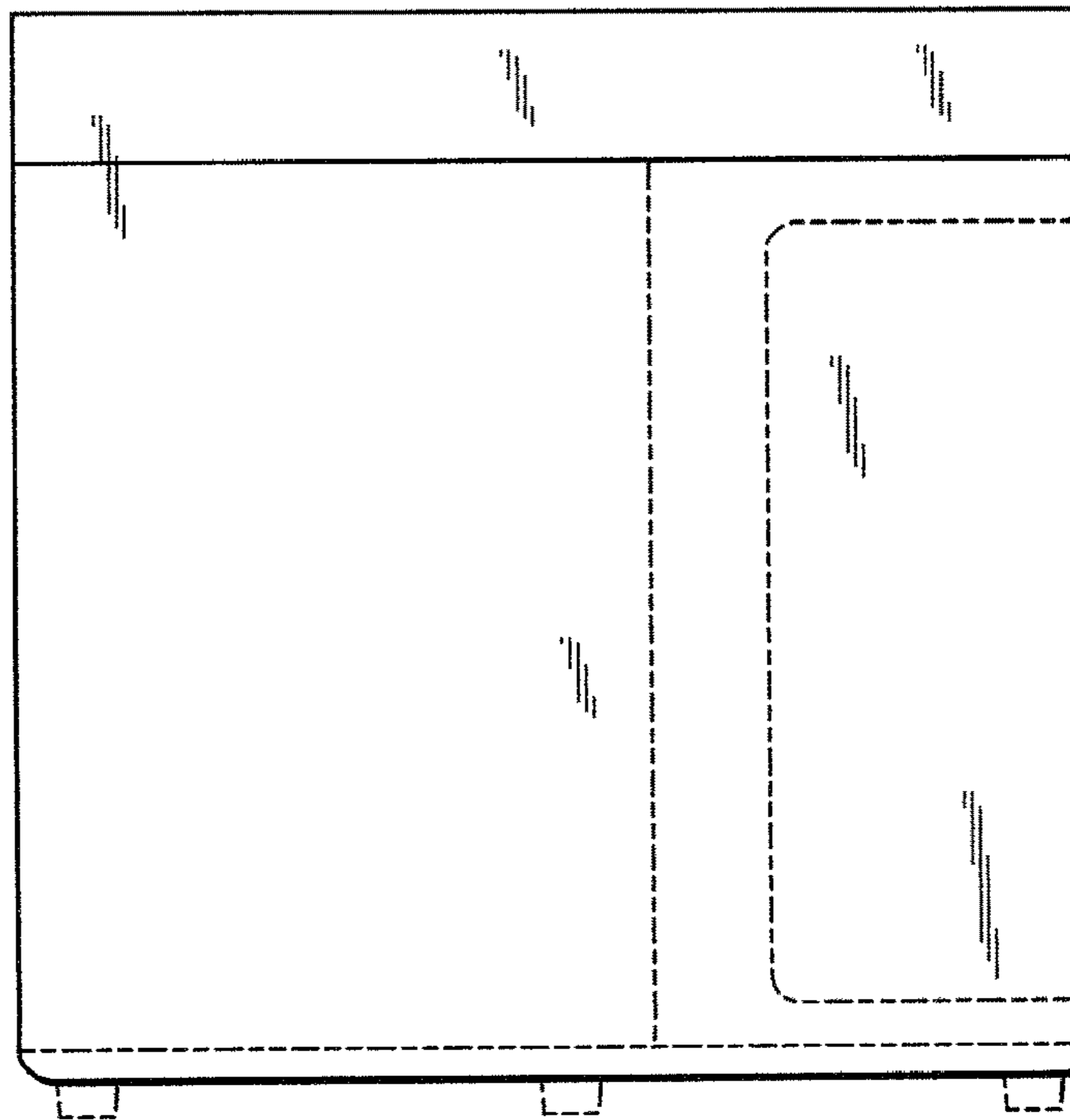

Figure 5

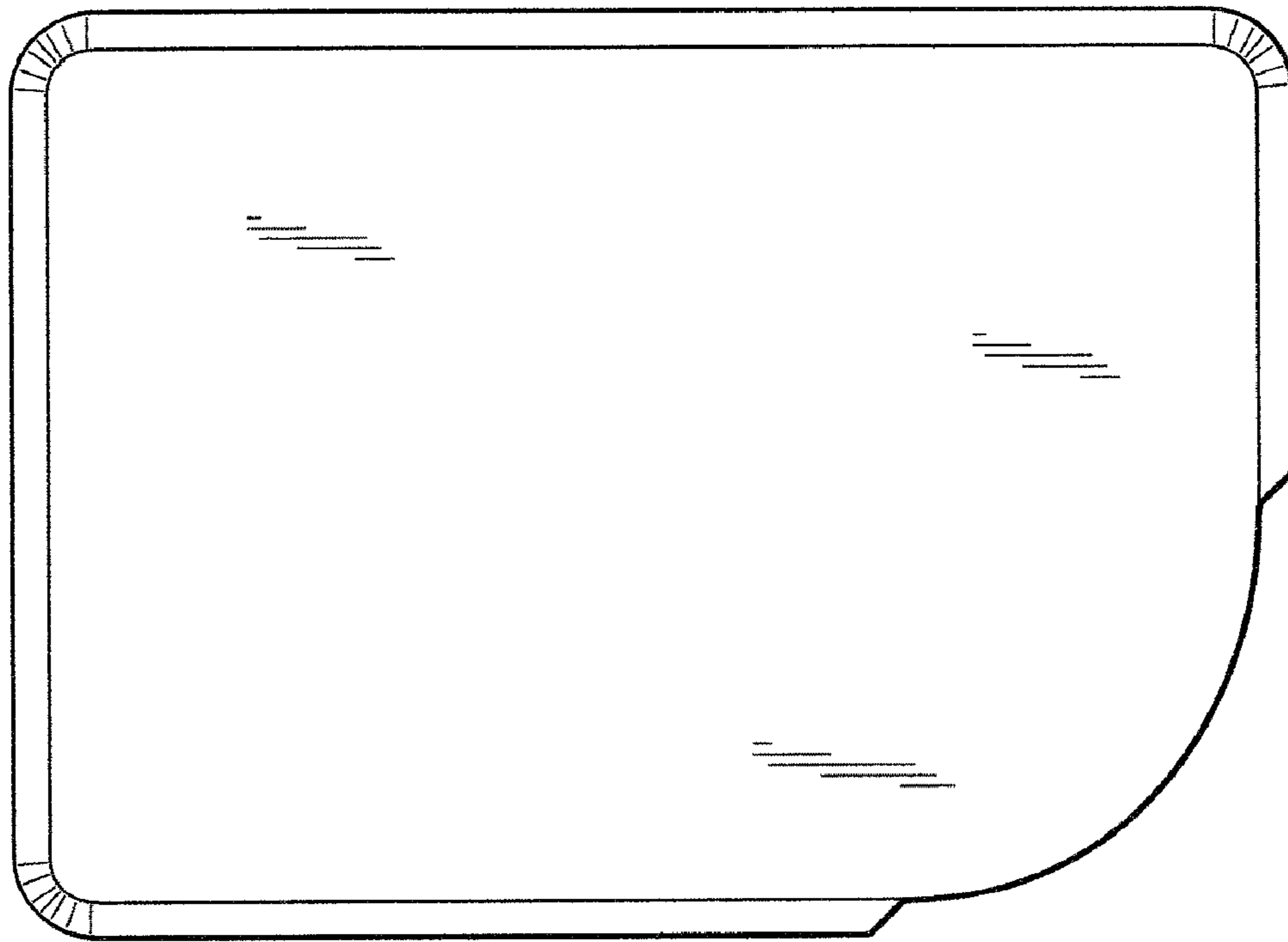

Figure 6

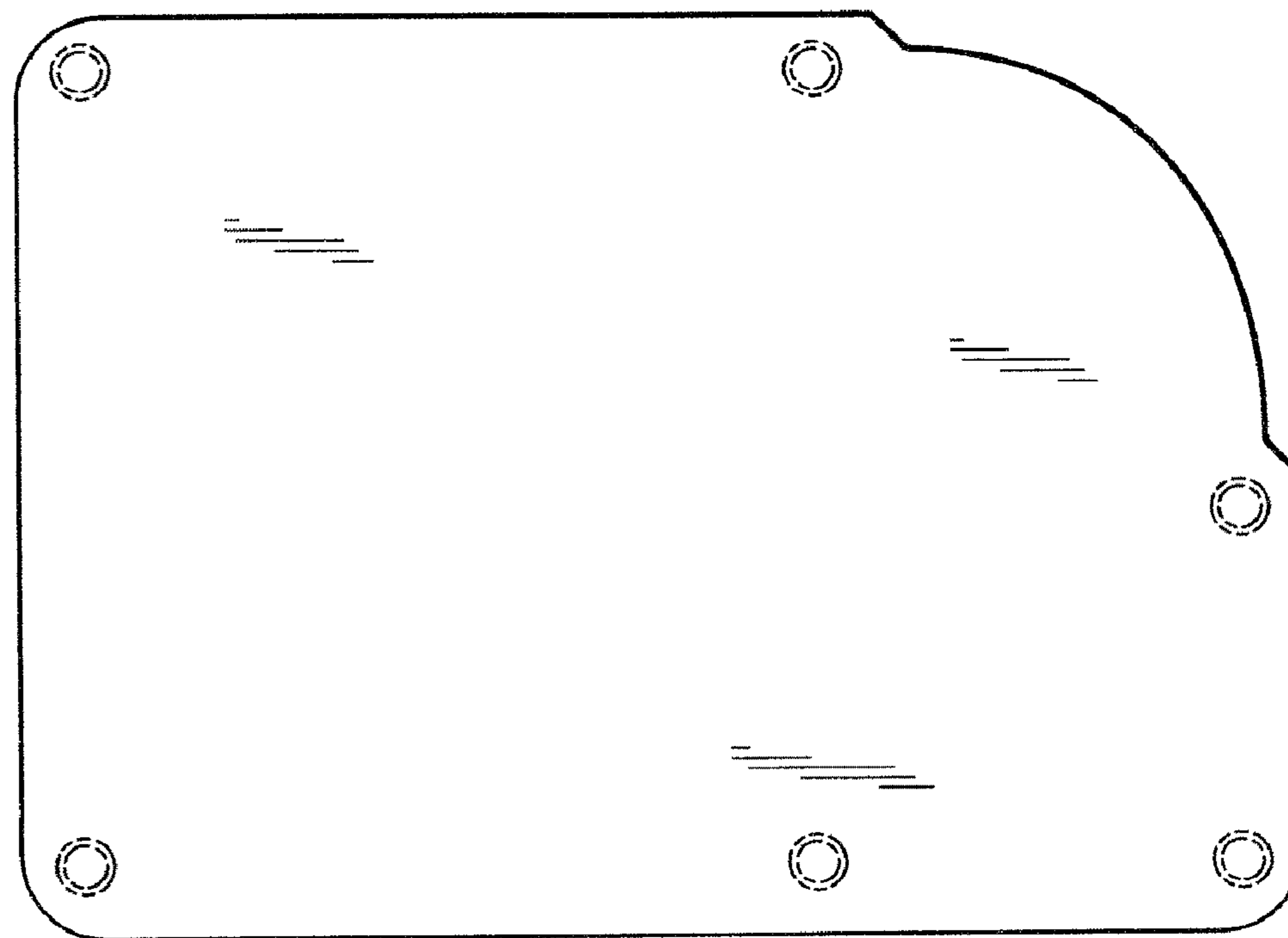

Figure 7

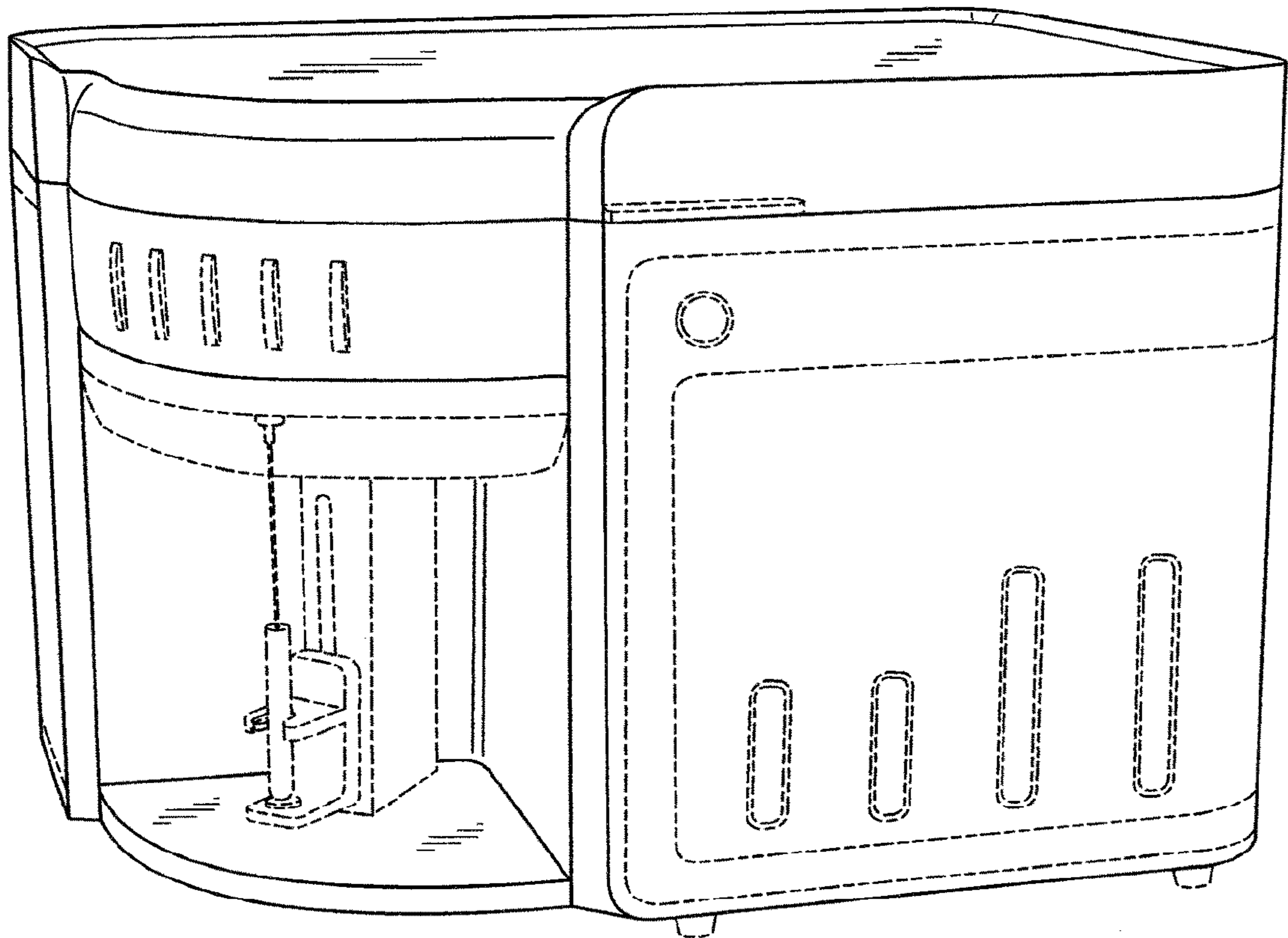

Figure 8

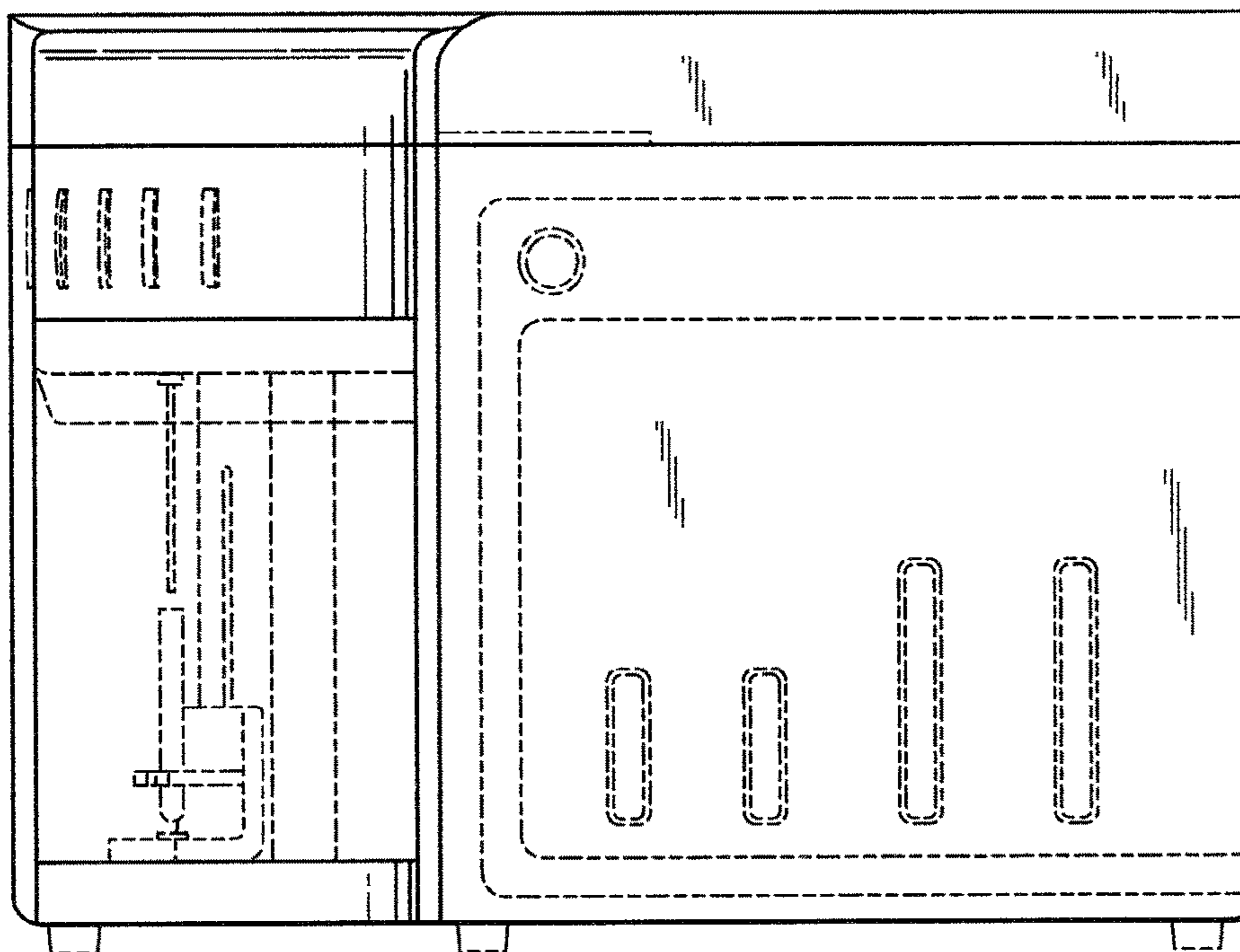

Figure 9

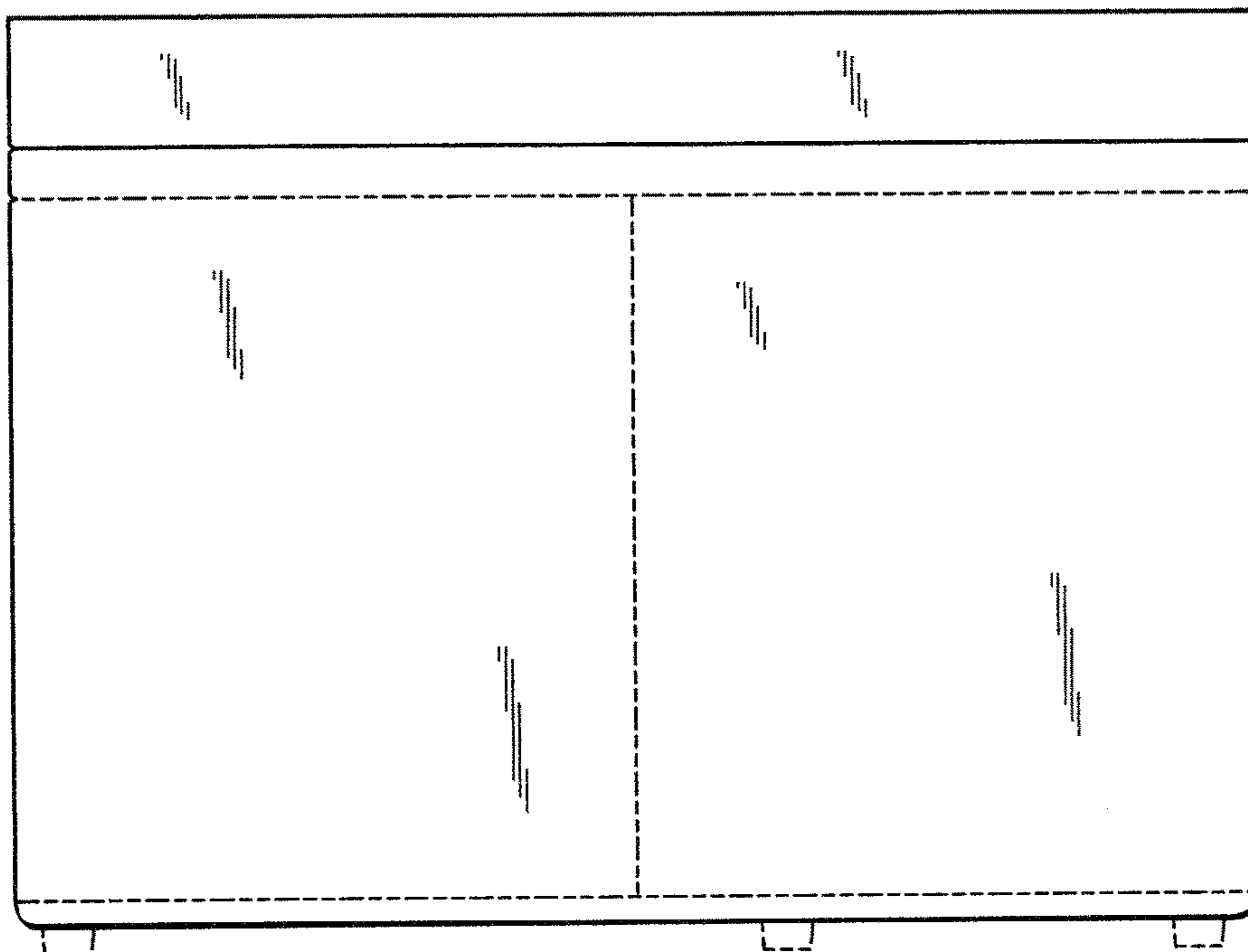

Figure 10

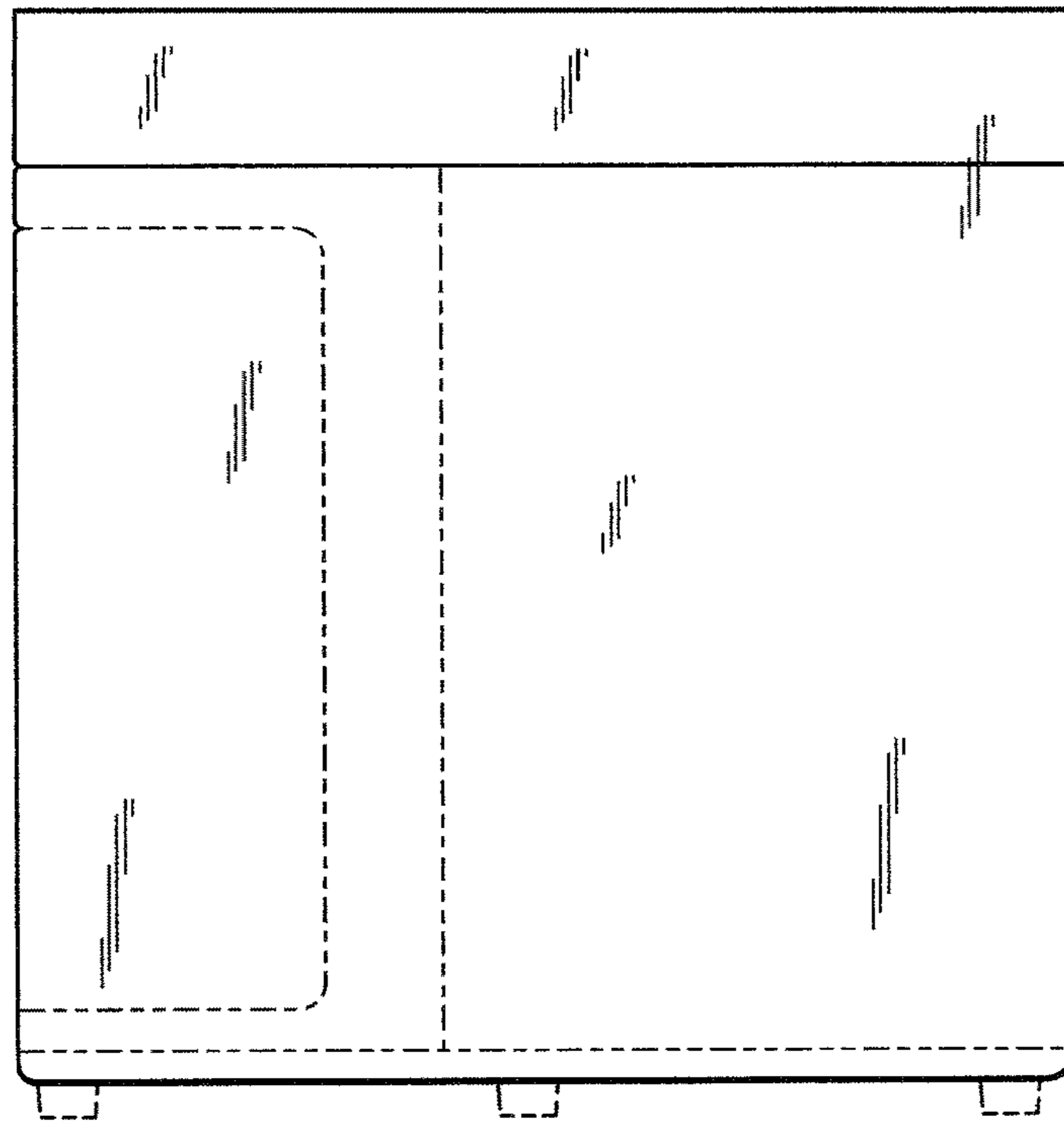

Figure 11

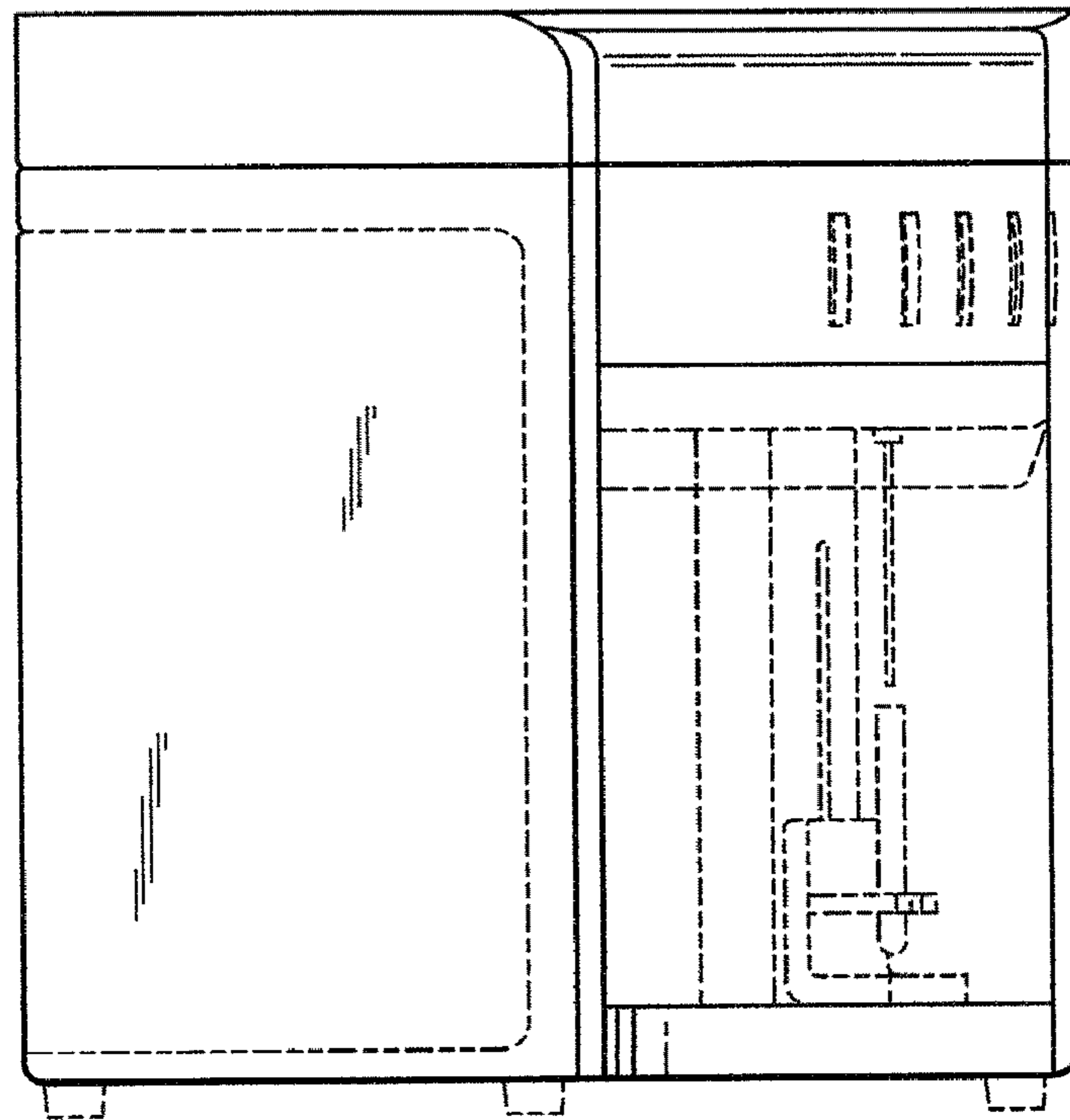

Figure 12

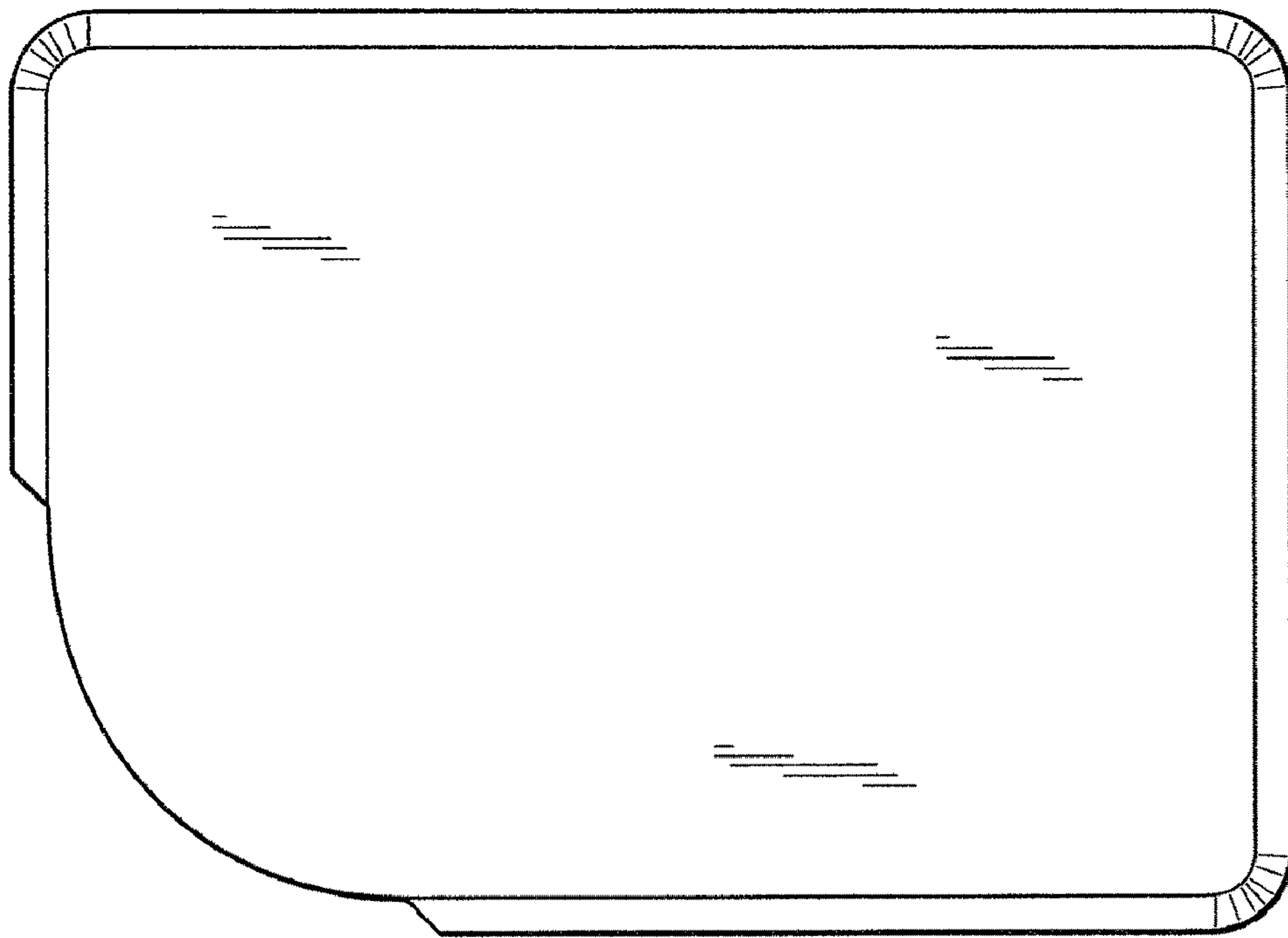

Figure 13

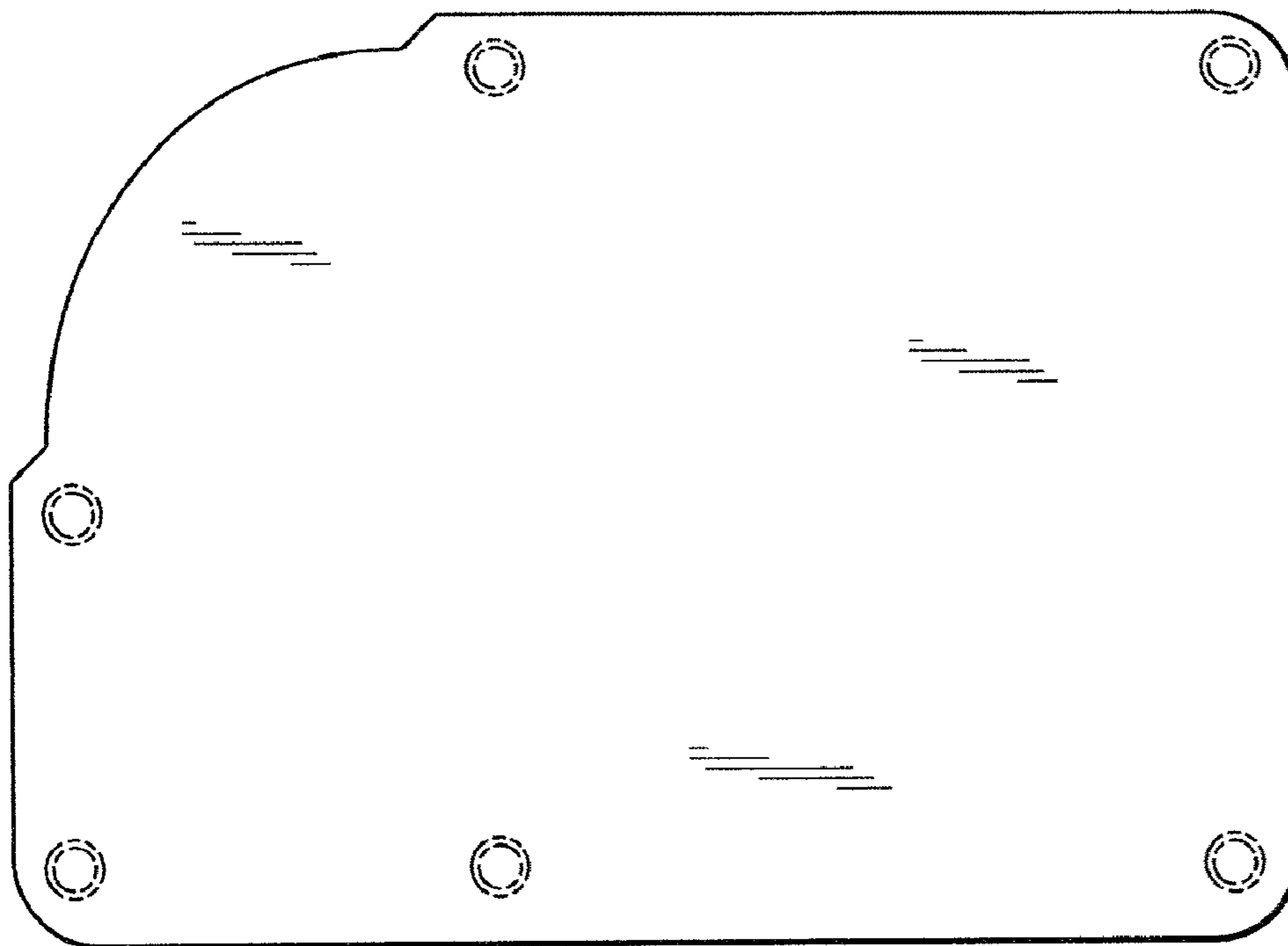

Figure 14

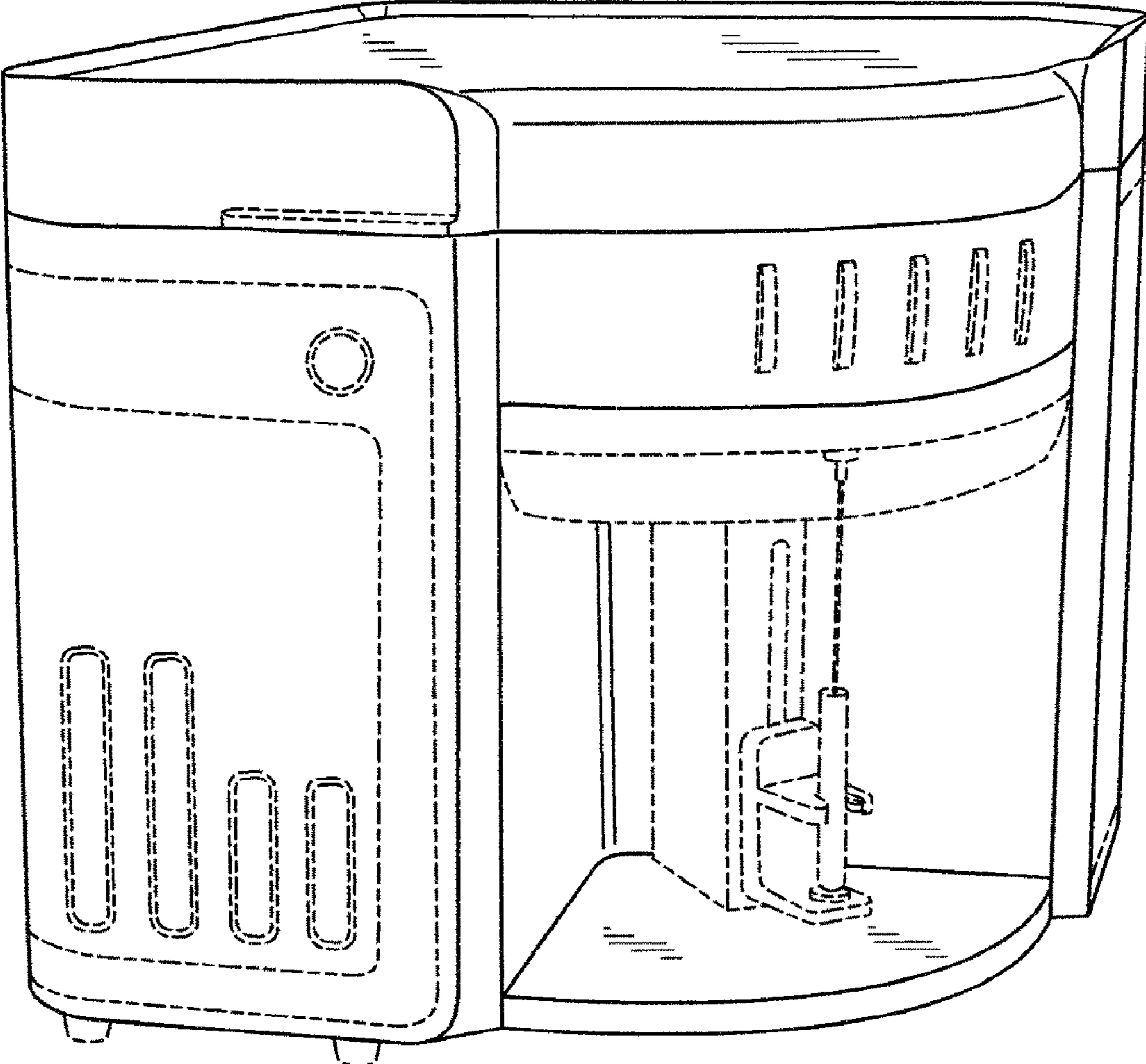

Figure 15

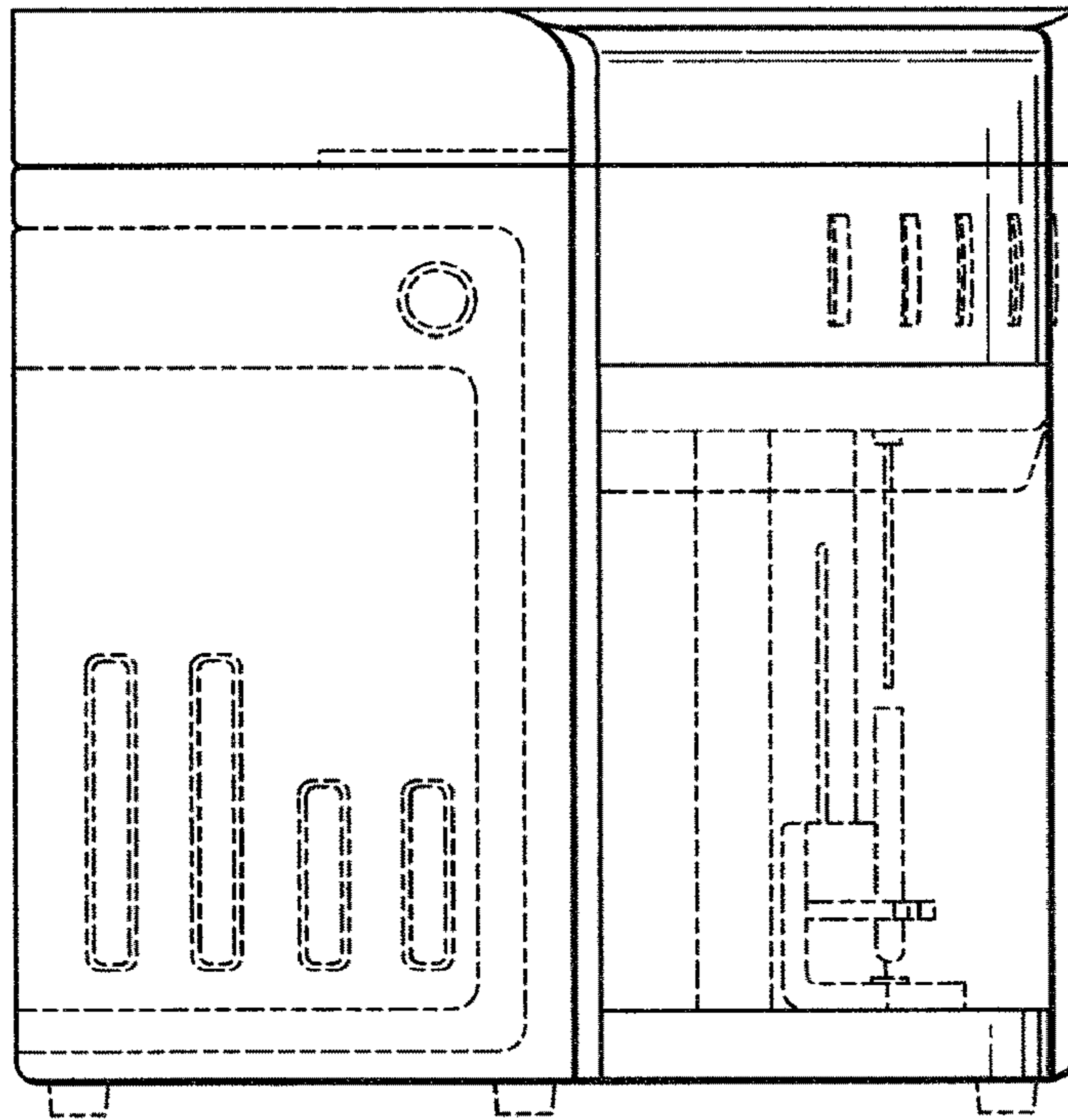

Figure 16

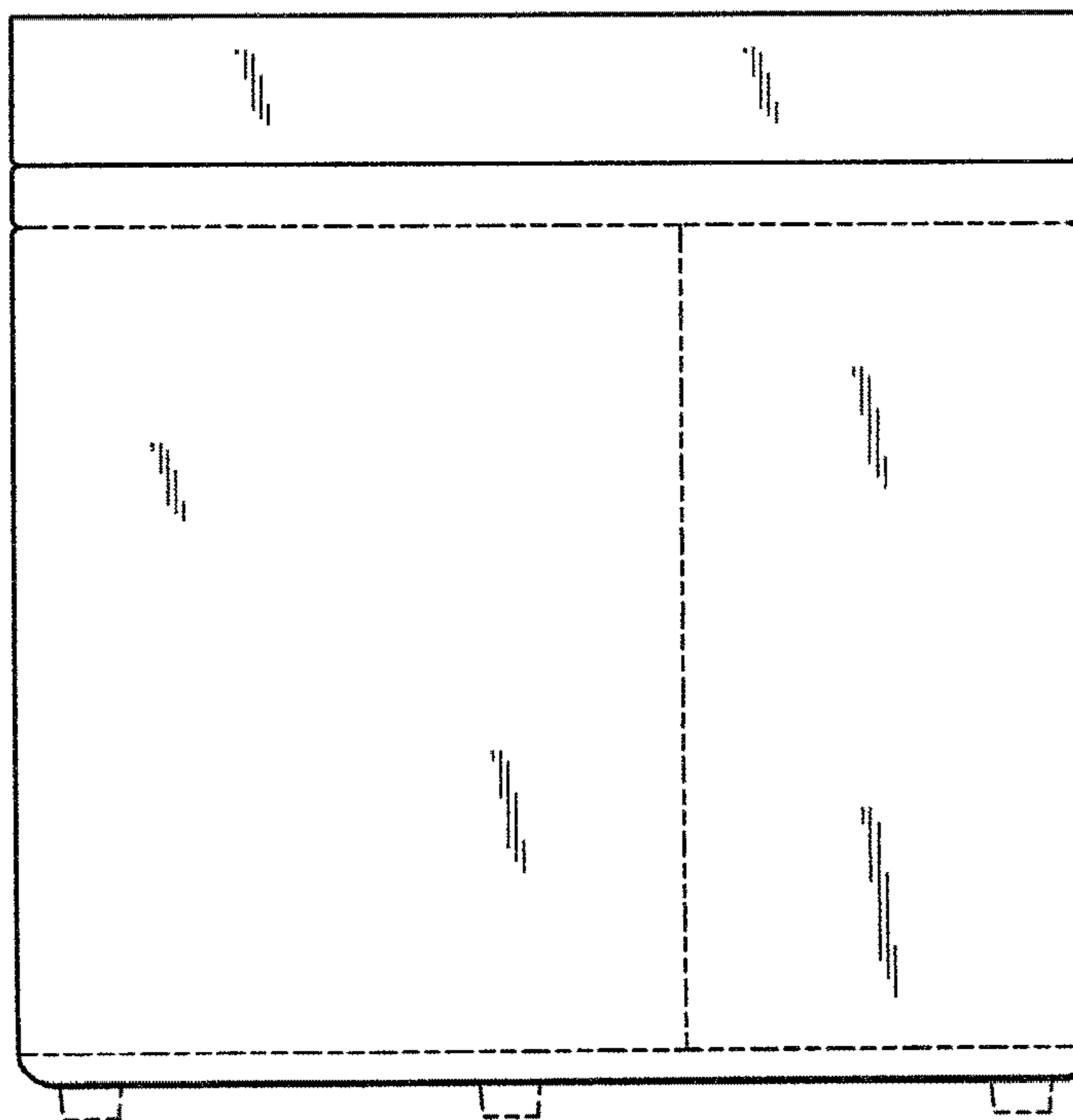

Figure 17

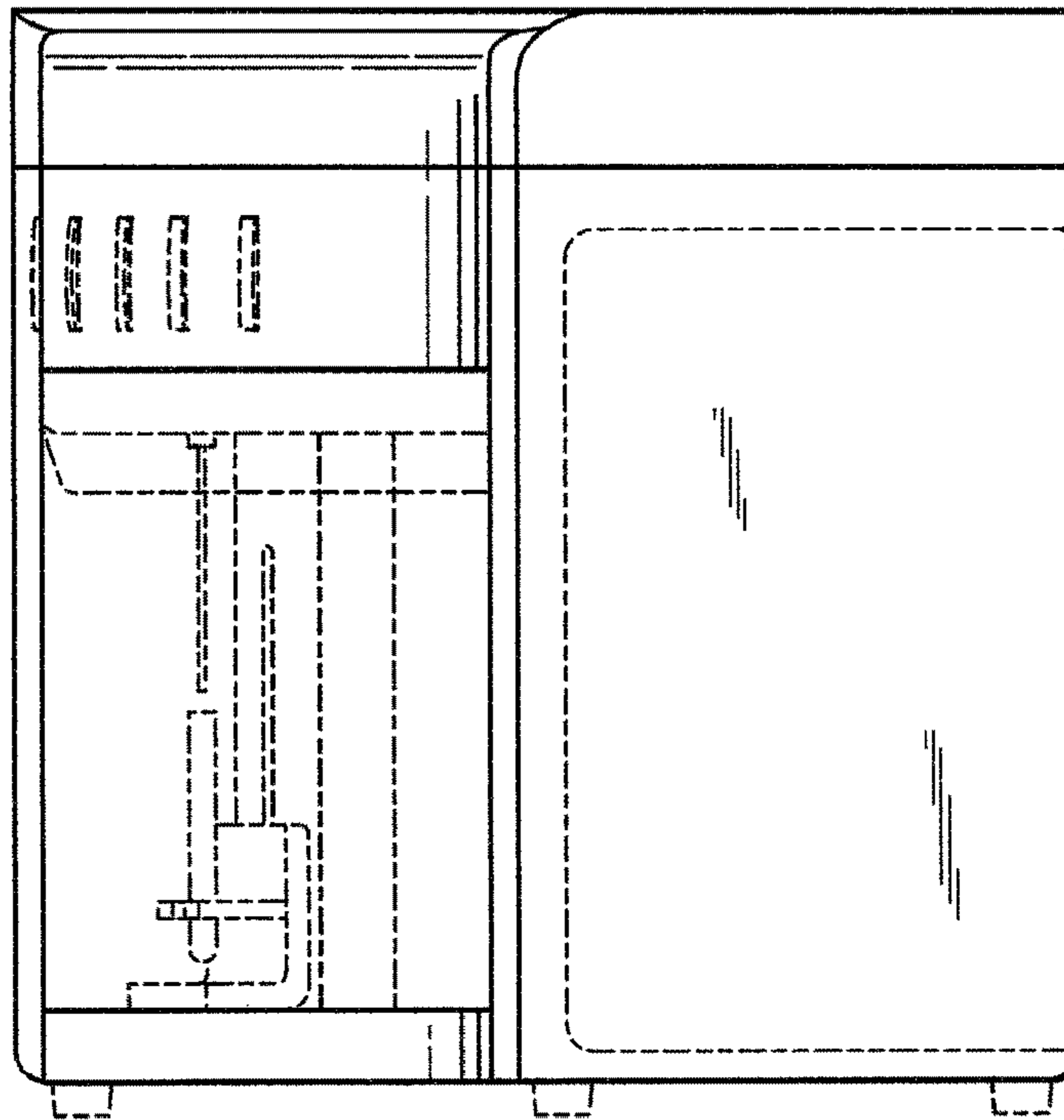

Figure 18

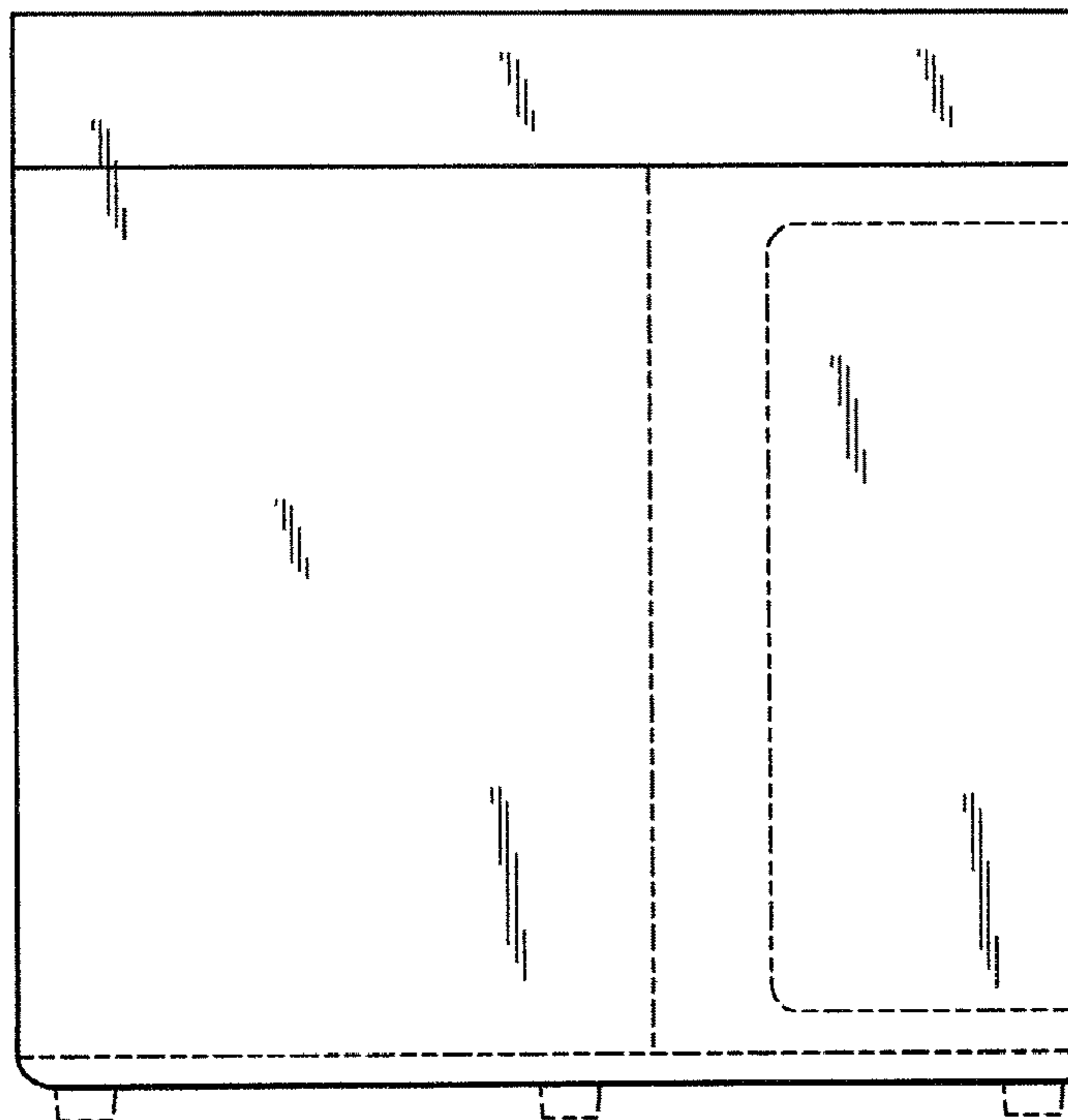

Figure 19

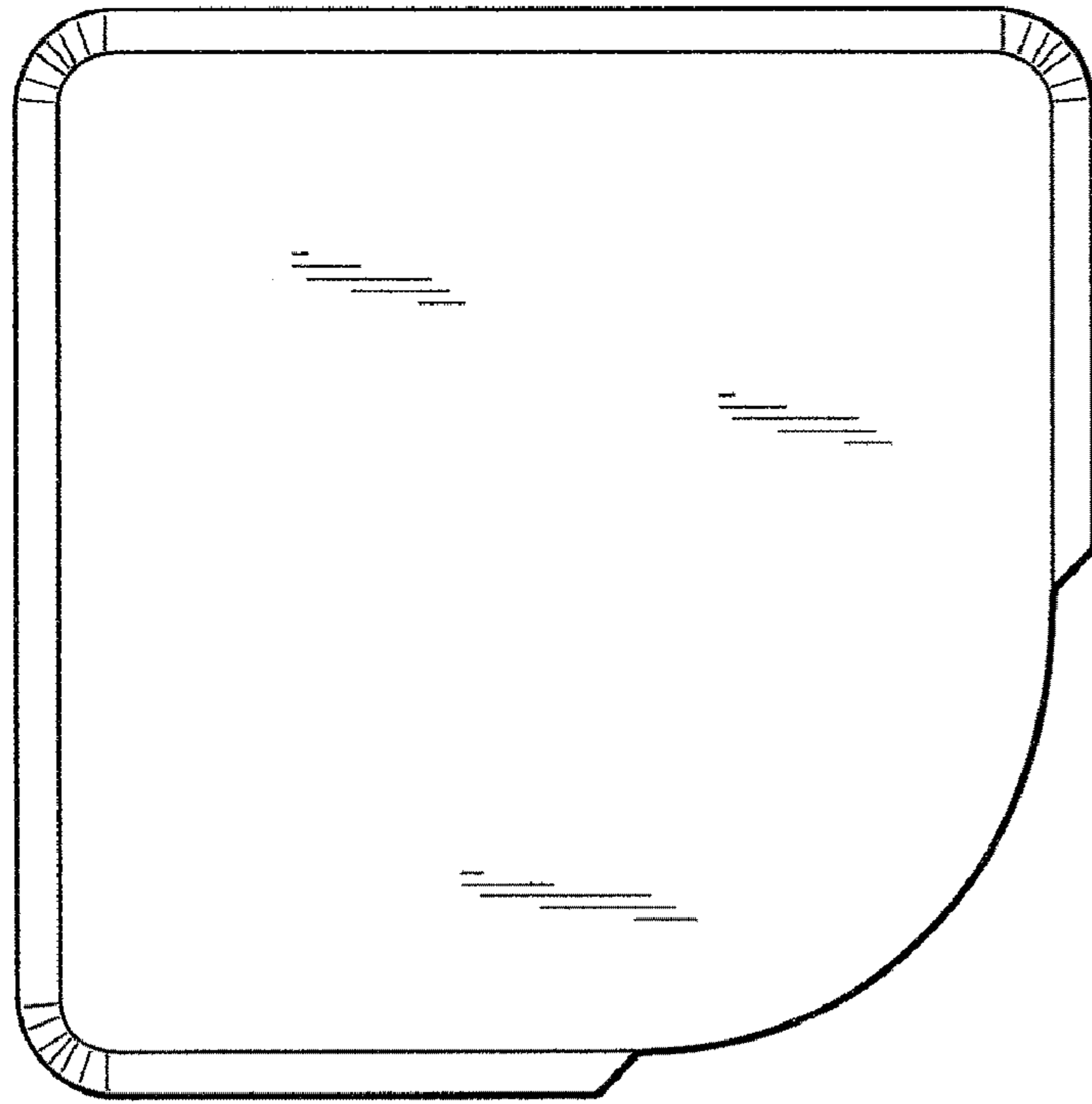

Figure 20

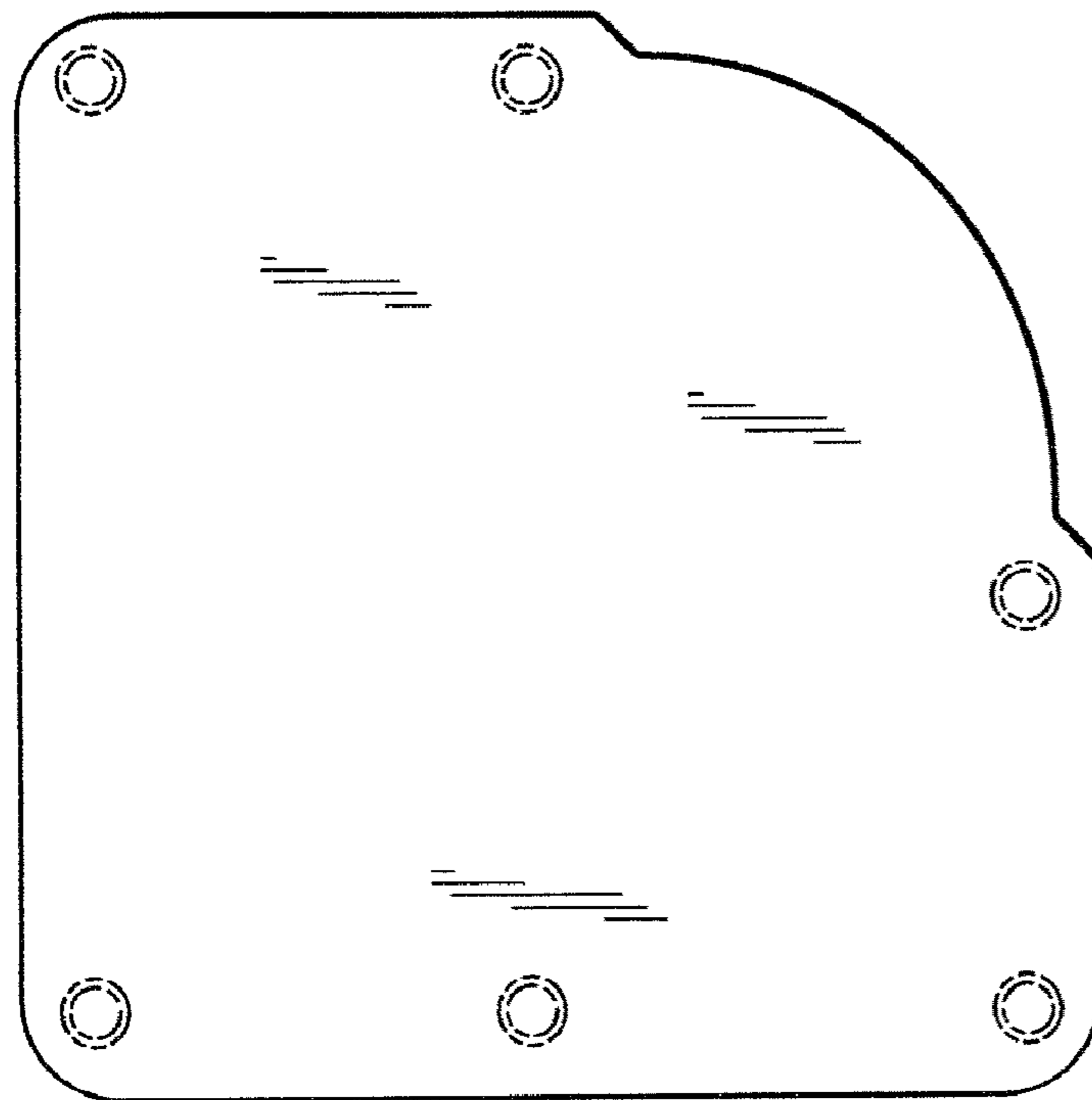

Figure 21

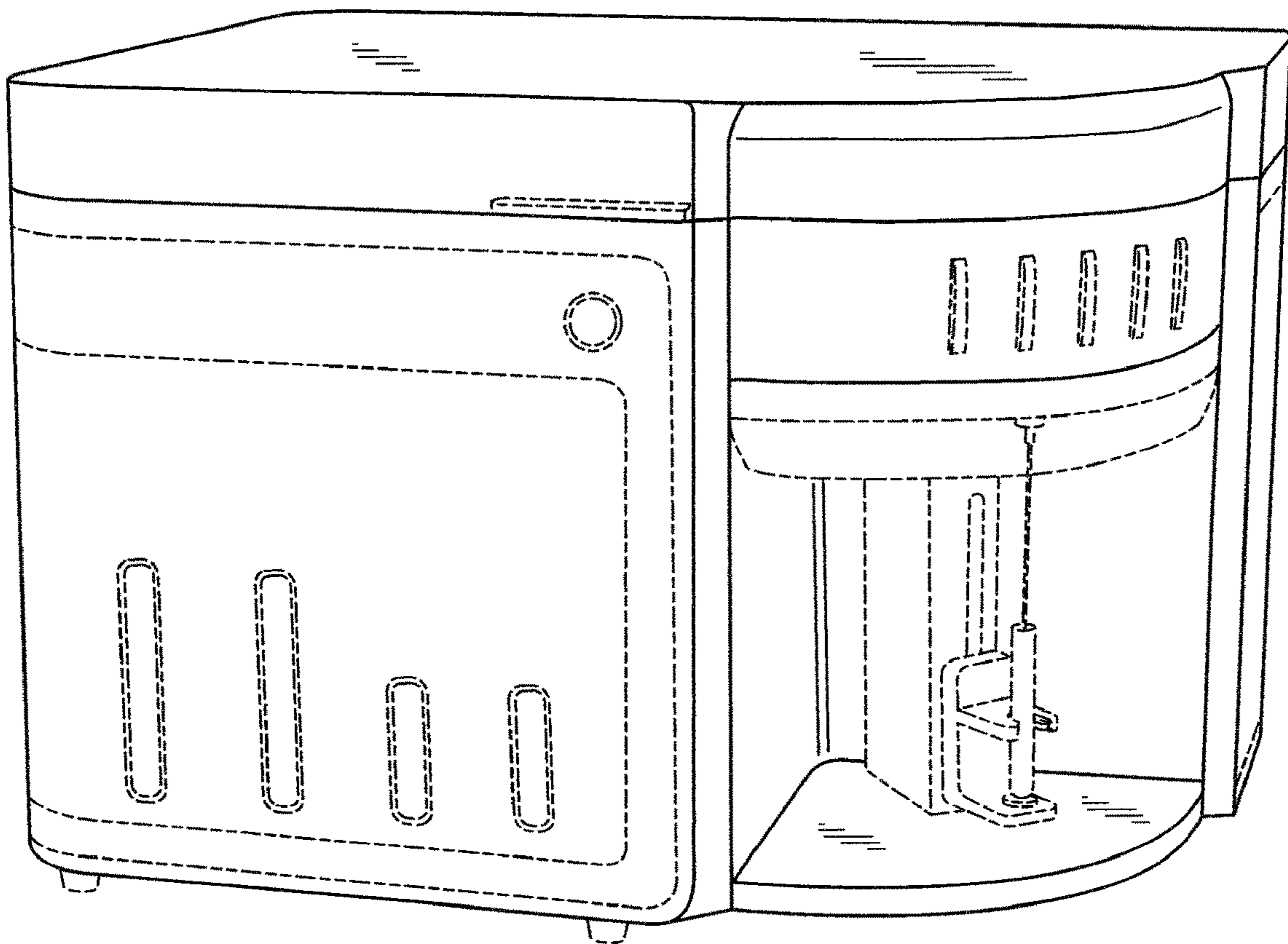

Figure 22

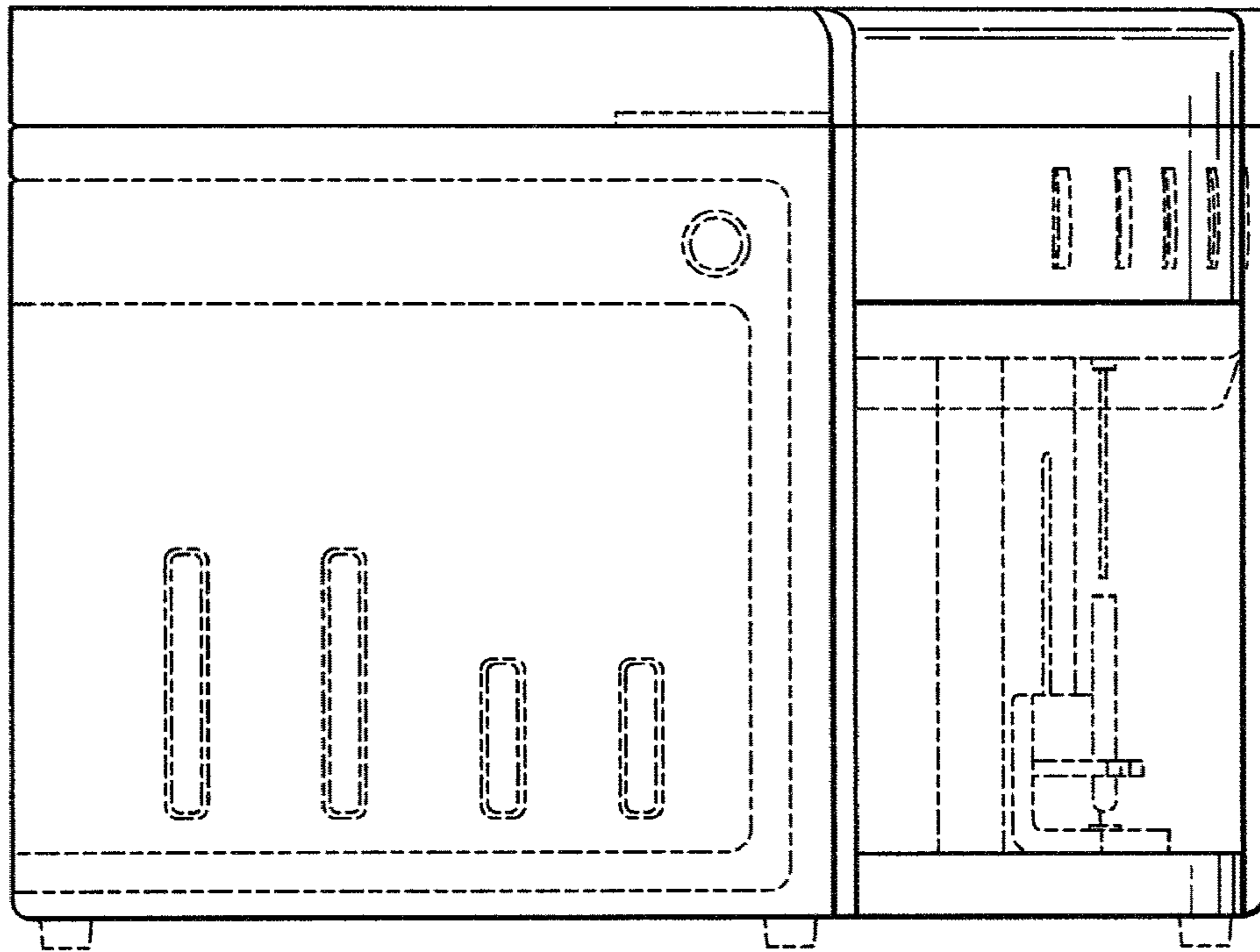

Figure 23

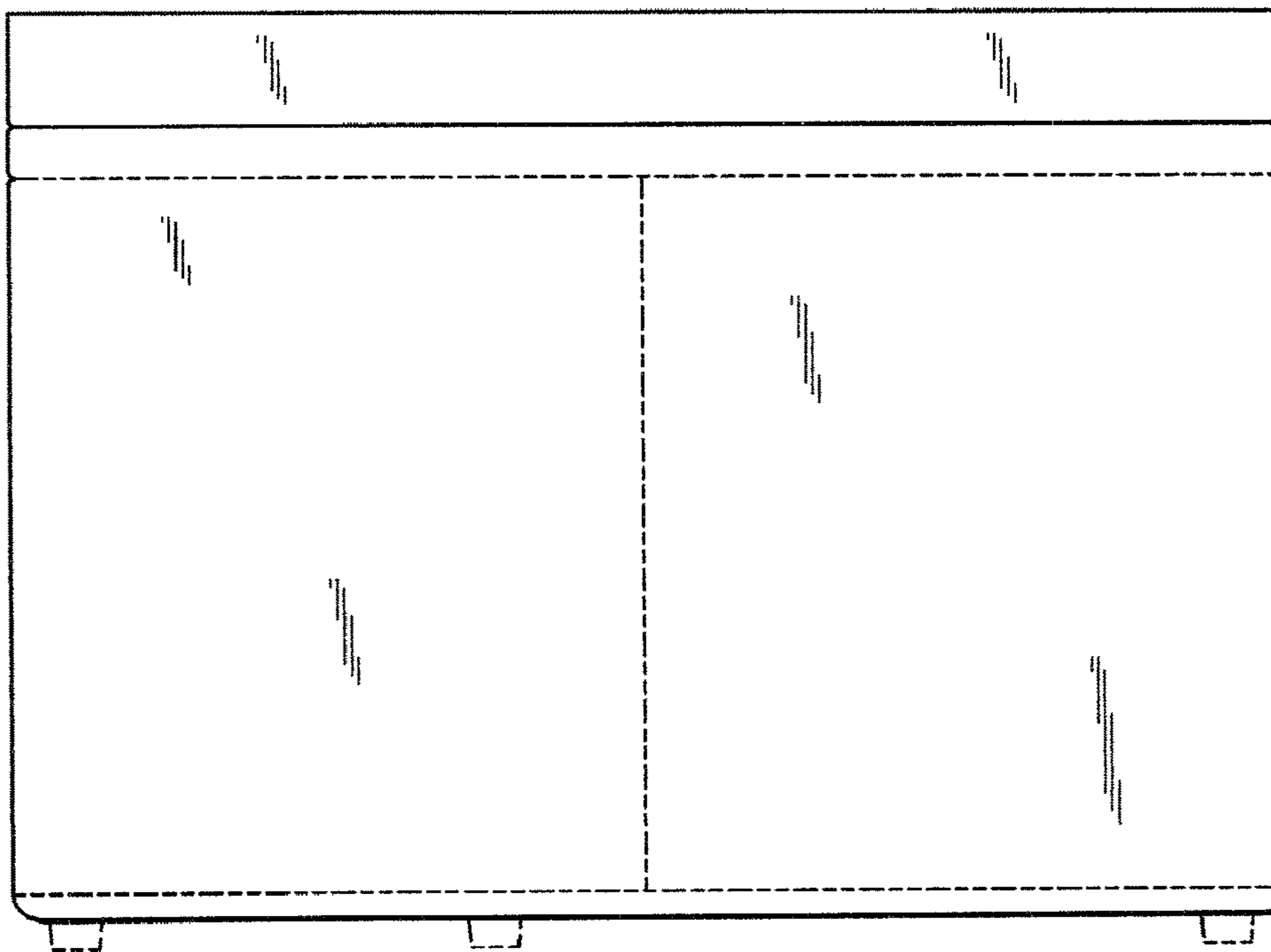

Figure 24

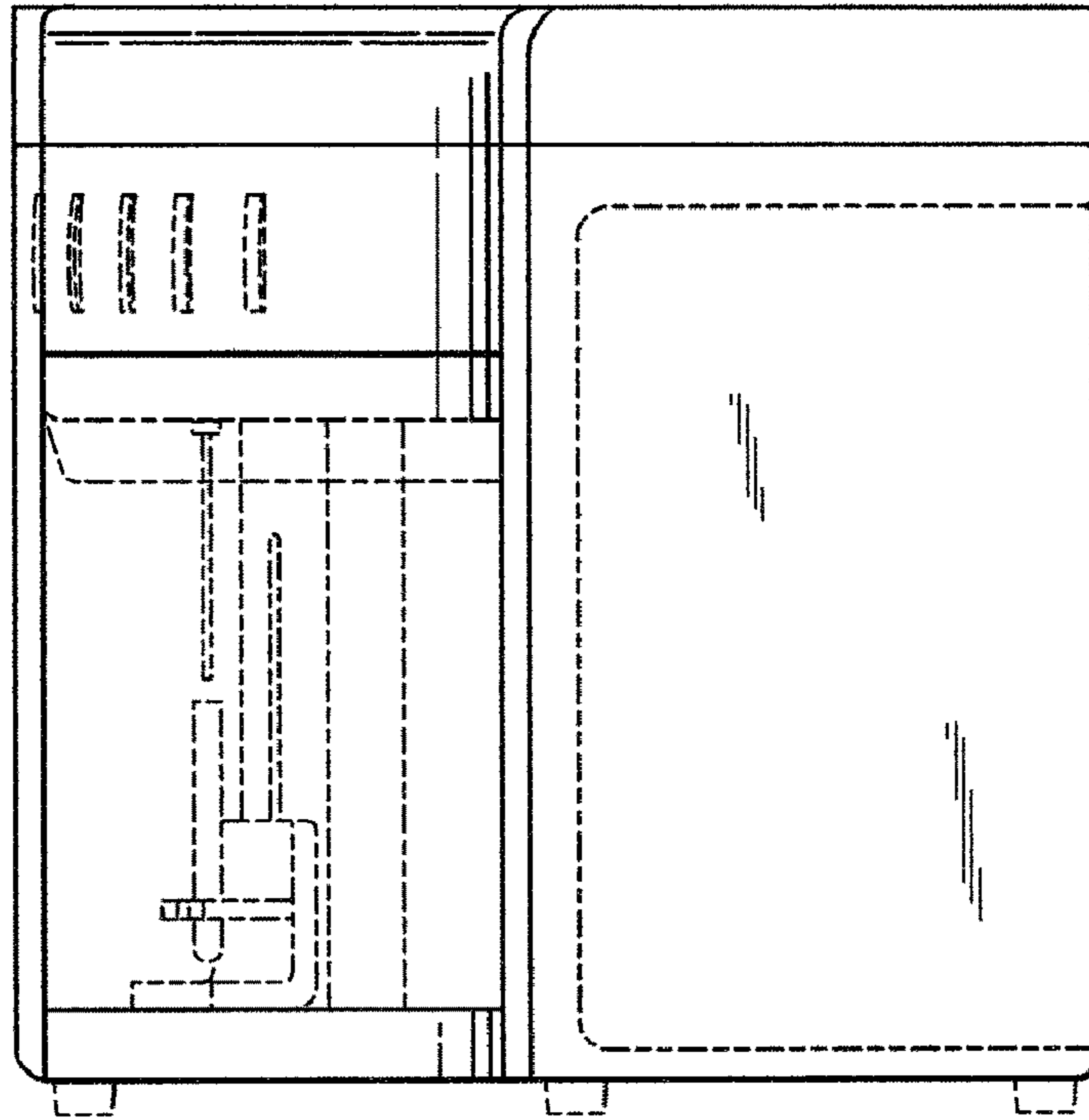

Figure 25

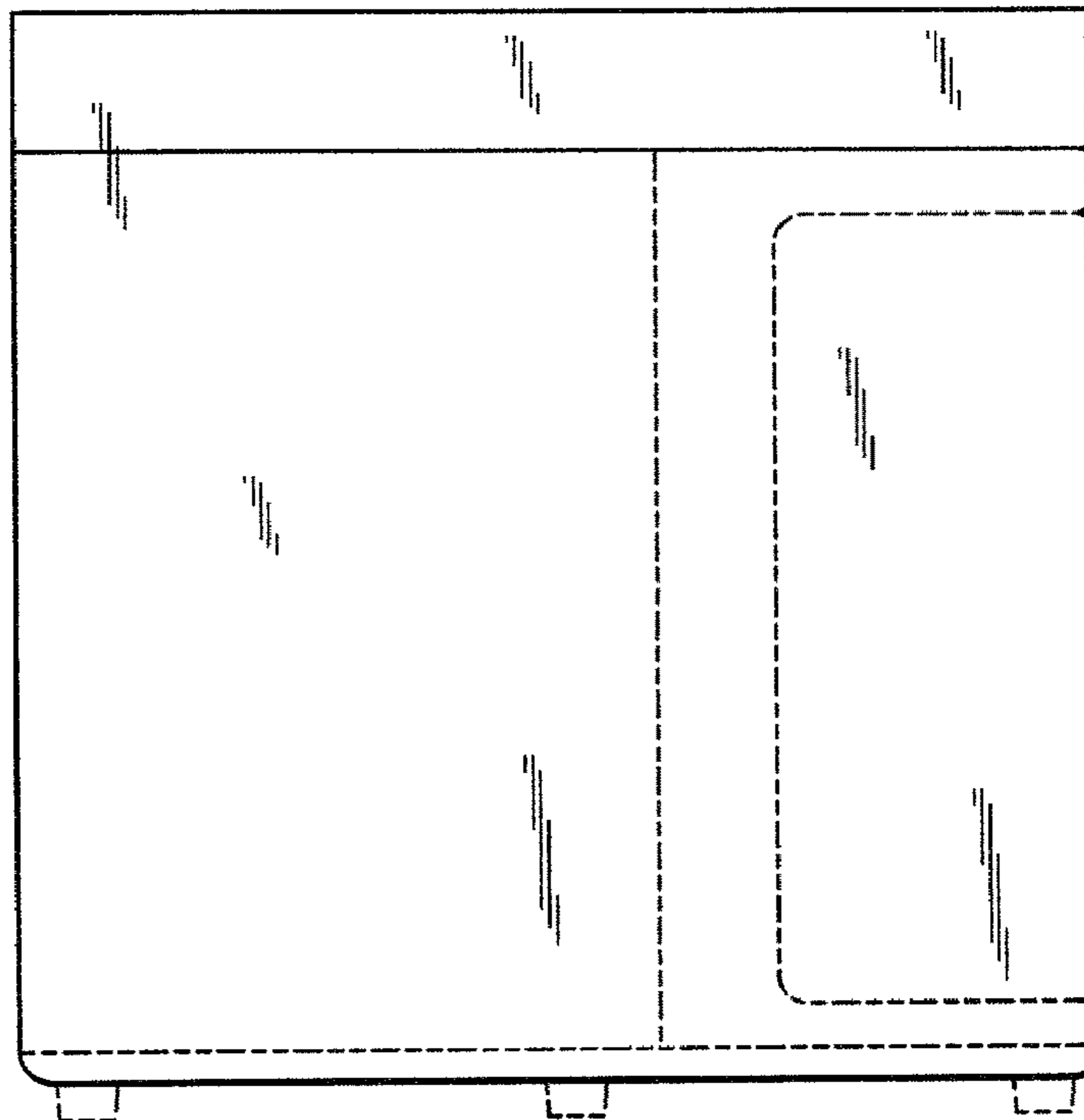

Figure 26



Figure 27

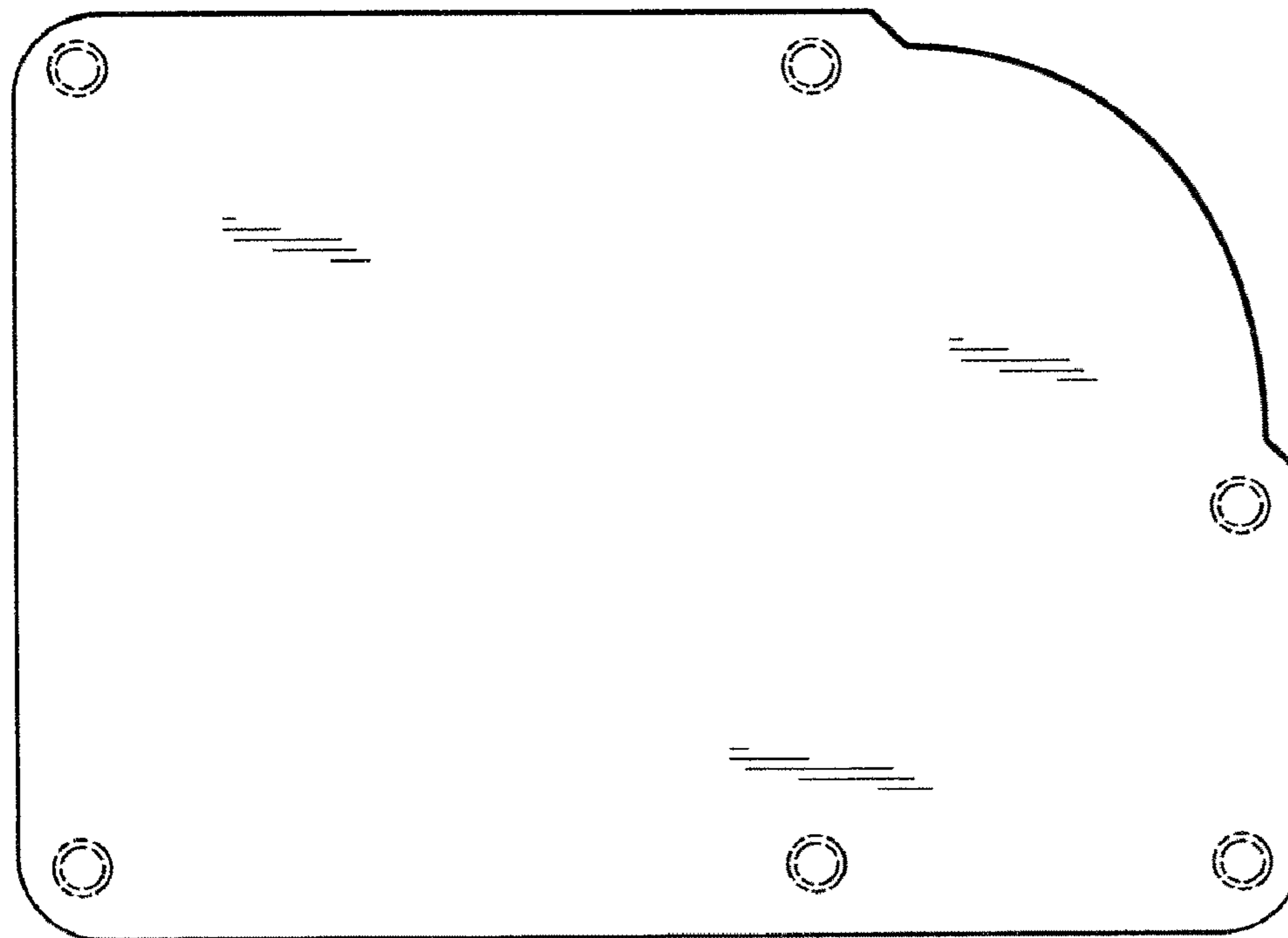

Figure 28