



US00D651058S

(12) **United States Design Patent**  
**Monnier et al.**

(10) **Patent No.:** **US D651,058 S**

(45) **Date of Patent:** **\*\* Dec. 27, 2011**

(54) **STAPLER**

(75) Inventors: **Vân Hong Tran Monnier**, Eden Prairie, MN (US); **Thomas P. Kuehn**, St. Louis Park, MN (US); **Stacy L. Abel**, Maple Grove, MN (US)

(73) Assignee: **Target Brands, Inc.**, Minneapolis, MN (US)

(\*\*) Term: **14 Years**

(21) Appl. No.: **29/393,142**

(22) Filed: **May 31, 2011**

(51) **LOC (9) Cl.** ..... **19-02**

(52) **U.S. Cl.** ..... **D8/50**

(58) **Field of Classification Search** ..... D8/49, D8/50, 61, 68, 69; D19/72, 73, 65, 69; D21/532; D24/145; 7/158, 160; 227/4, 5, 6, 7, 8, 120, 227/127, 128, 131, 132, 134, 144, 156, 175.1; 606/139, 143, 153, 219

See application file for complete search history.

(56) **References Cited**

U.S. PATENT DOCUMENTS

D147,972 S *	11/1947	Ide	.....	D8/50
D208,780 S *	10/1967	Smith	.....	D19/61
D246,659 S	12/1977	Vailati		
D256,326 S *	8/1980	Murtagh	.....	D8/50
D261,165 S	10/1981	Kurosawa et al.		
D338,041 S *	8/1993	Cheng	.....	D19/75
D416,592 S	11/1999	Leadbetter		
D433,062 S *	10/2000	Ho	.....	D19/72
6,338,430 B1 *	1/2002	Cheng	.....	227/134
D457,103 S *	5/2002	Domenig	.....	D11/160
D461,952 S *	8/2002	Chan	.....	D3/219
D491,230 S *	6/2004	Lee	.....	D19/72
D500,175 S	12/2004	Hood		

D515,374 S *	2/2006	Sinisi	.....	D8/50
D530,998 S *	10/2006	Mountford	.....	D8/50
D561,547 S *	2/2008	Lee	.....	D8/36
D564,178 S *	3/2008	Edwards et al.	.....	D1/109
D605,226 S *	12/2009	Nishimura	.....	D19/72
D632,999 S *	2/2011	Yeh	.....	D11/158
D638,272 S *	5/2011	Chen	.....	D8/50

\* cited by examiner

*Primary Examiner* — Austin Murphy

(74) *Attorney, Agent, or Firm* — Leanne Taveggia Farrell; Westman, Champlin & Kelly, P.A.

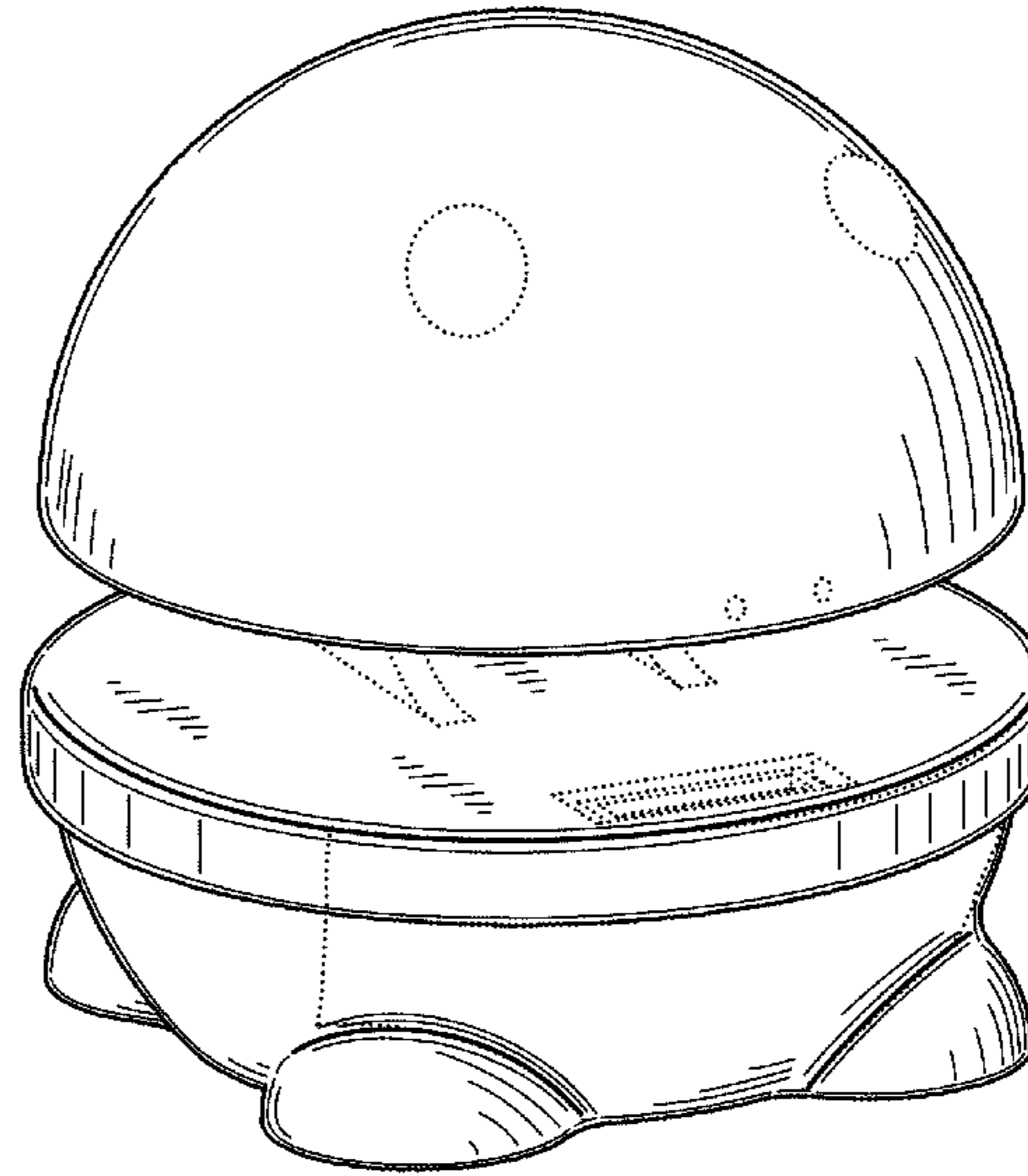
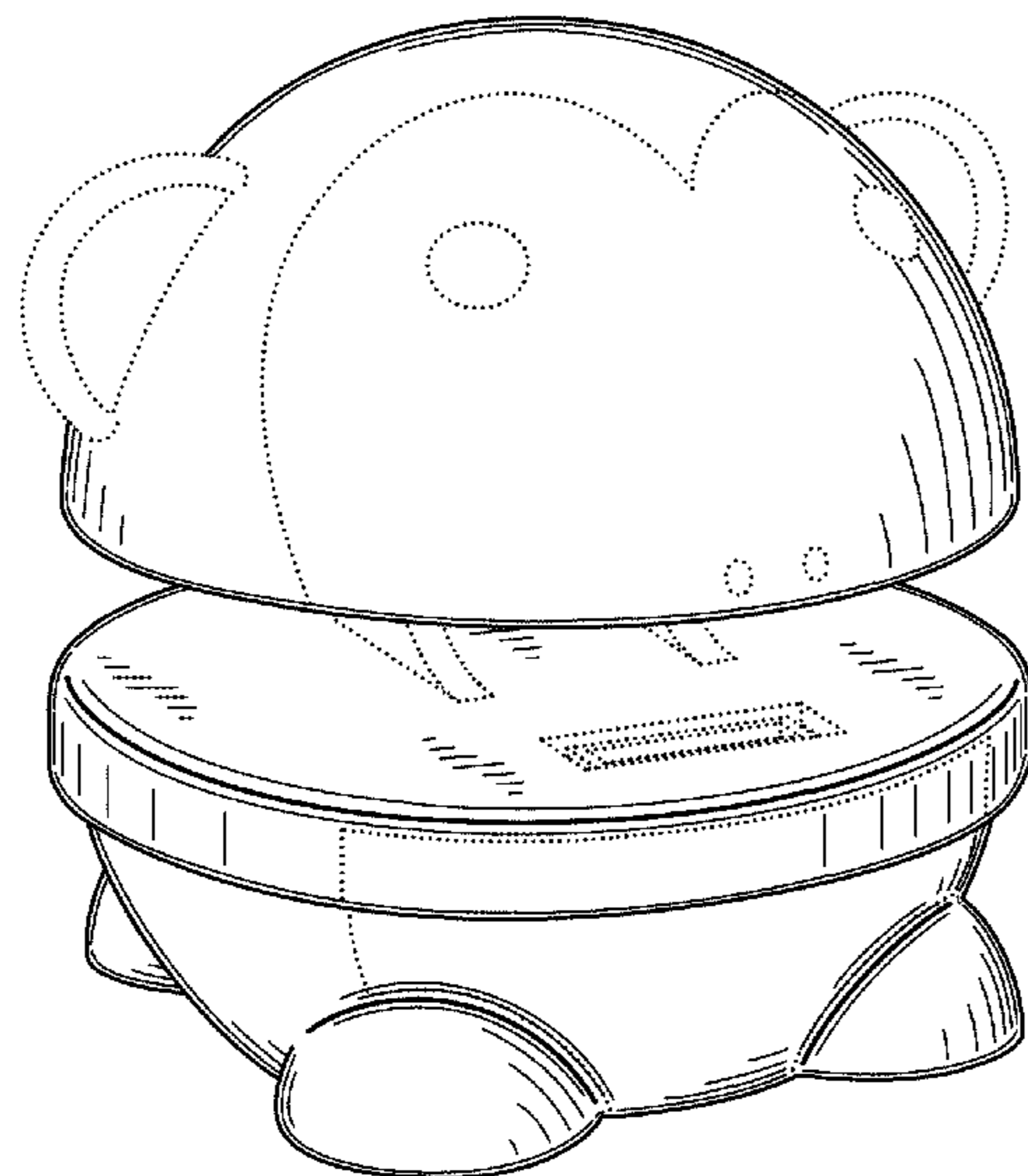
(57) **CLAIM**

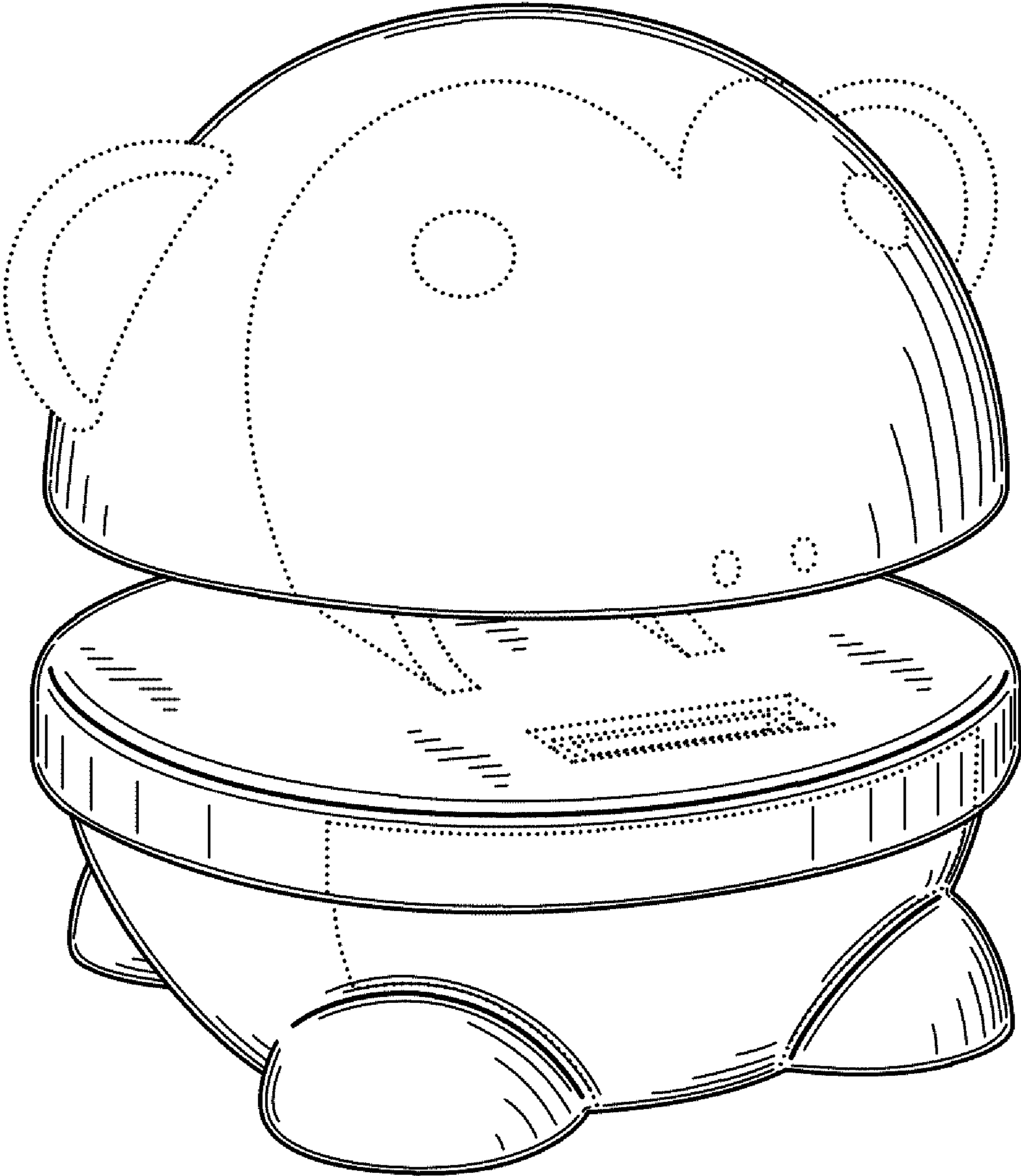
The ornamental design for a stapler, as shown and described.

**DESCRIPTION**

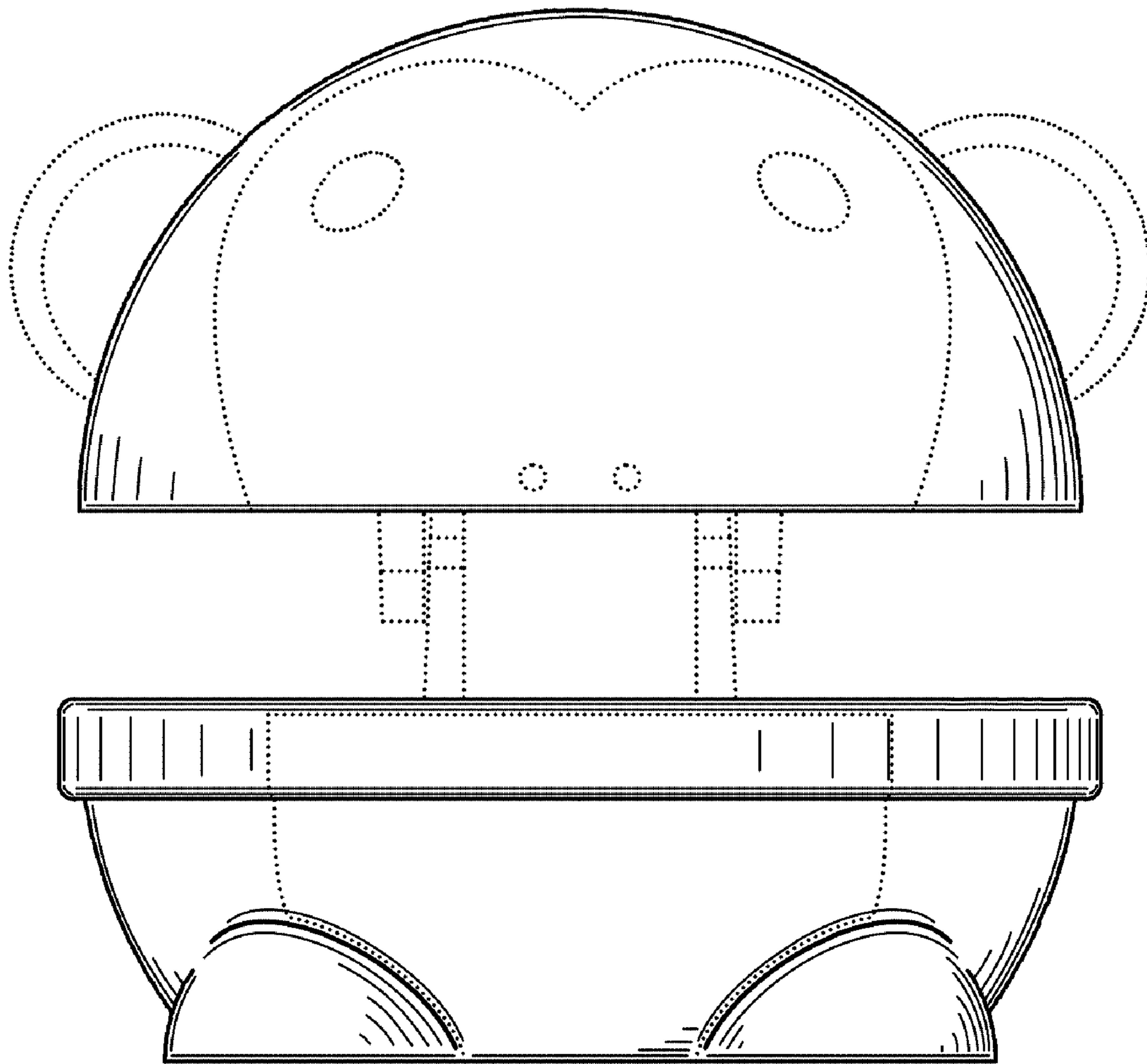
FIG. 1 is a perspective view of one embodiment of the stapler. FIG. 2 is a front view of the stapler illustrated in FIG. 1. FIG. 3 is a back view of the stapler illustrated in FIG. 1. FIG. 4 is a left side view of the stapler illustrated in FIG. 1. FIG. 5 is a right side view of the stapler illustrated in FIG. 1. FIG. 6 is a top view of the stapler illustrated in FIG. 1. FIG. 7 is a bottom view of the stapler illustrated in FIG. 1. FIG. 8 is a perspective view of a second embodiment of the stapler. FIG. 9 is a front view of the stapler illustrated in FIG. 8. FIG. 10 is a back view of the stapler illustrated in FIG. 8. FIG. 11 is a left side view of the stapler illustrated in FIG. 8. FIG. 12 is a right side view of the stapler illustrated in FIG. 8. FIG. 13 is a top view of the stapler illustrated in FIG. 8. FIG. 14 is a bottom view of the stapler illustrated in FIG. 8. FIG. 15 is a perspective view of a third embodiment of the stapler. FIG. 16 is a front view of the stapler illustrated in FIG. 15. FIG. 17 is a back view of the stapler illustrated in FIG. 15. FIG. 18 is a left side view of the stapler illustrated in FIG. 15. FIG. 19 is a right side view of the stapler illustrated in FIG. 15. FIG. 20 is a top view of the stapler illustrated in FIG. 15; and, FIG. 21 is a bottom view of the stapler illustrated in FIG. 15. The broken lines in FIGS. 1-21 form no part of the claimed design.

**1 Claim, 21 Drawing Sheets**



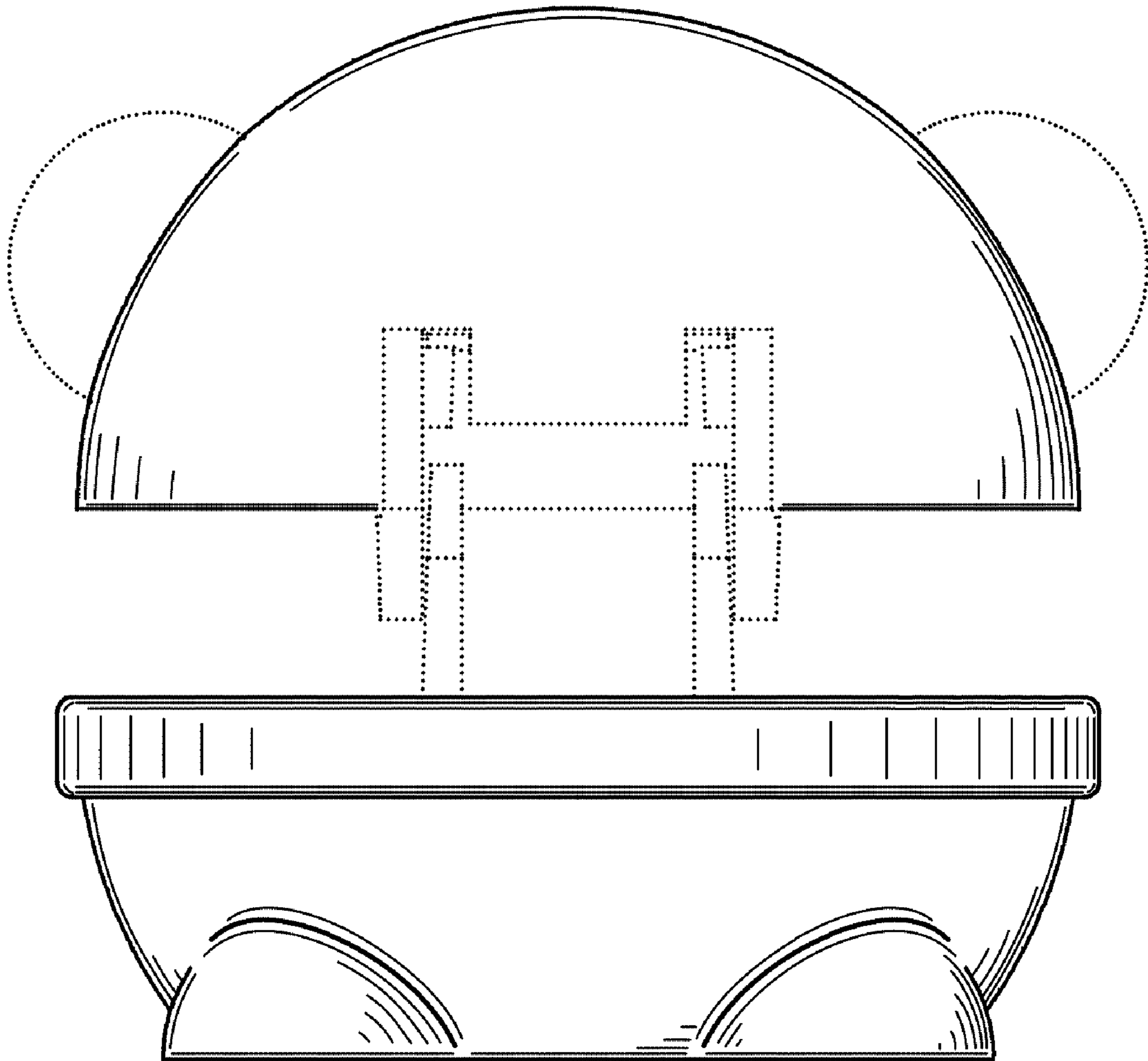


*Fig. 1*

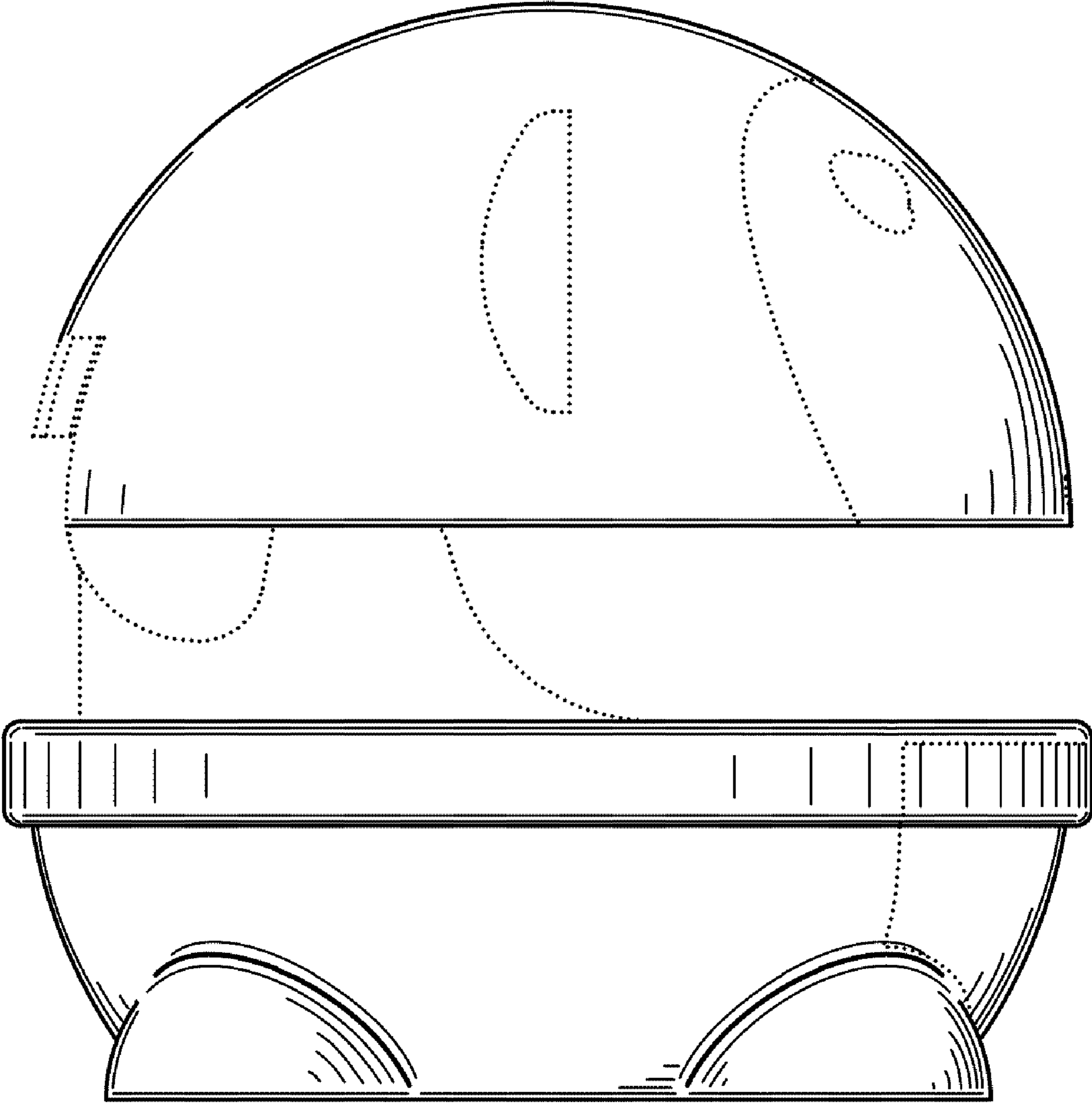


*Fig. 2*

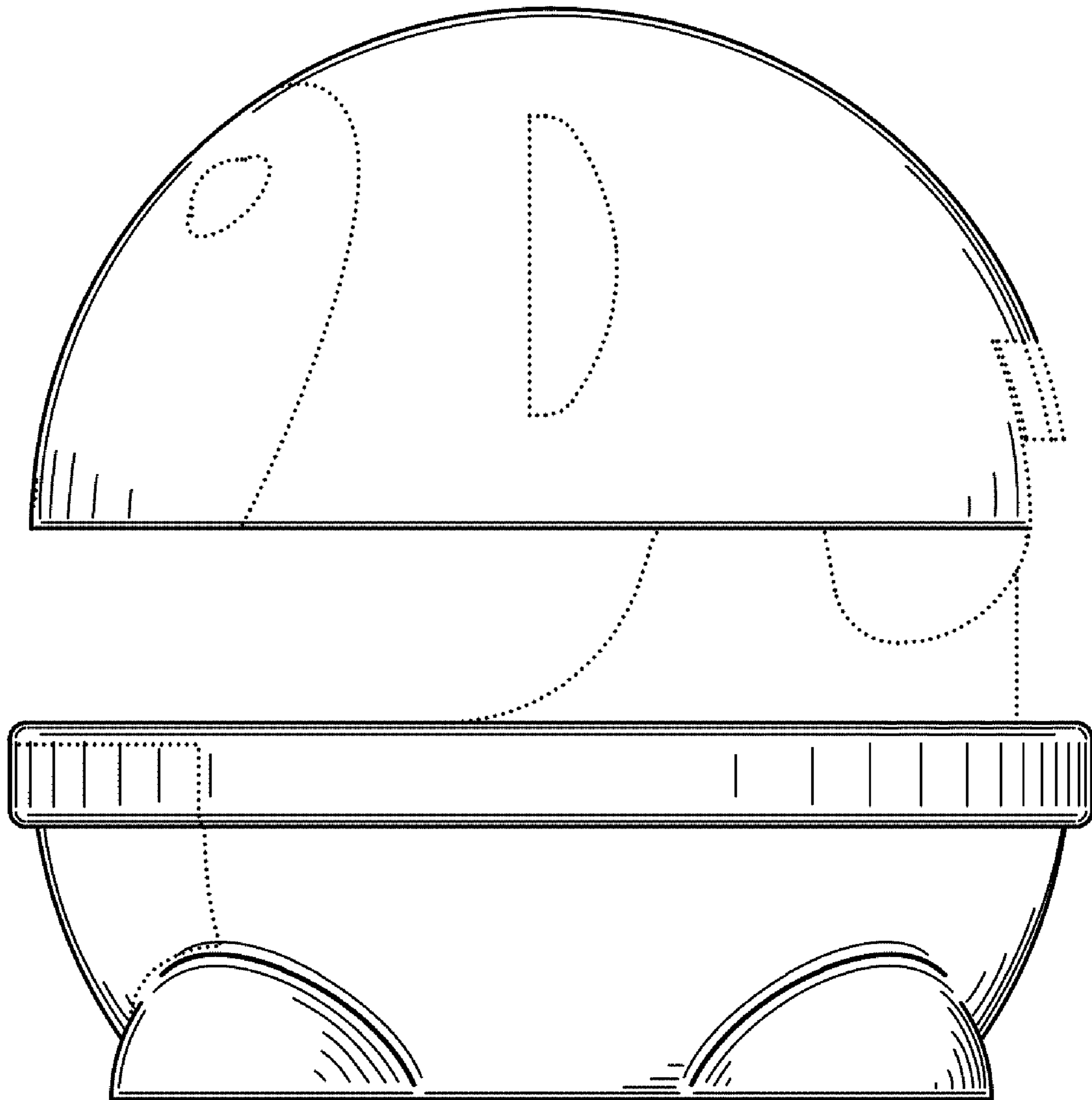




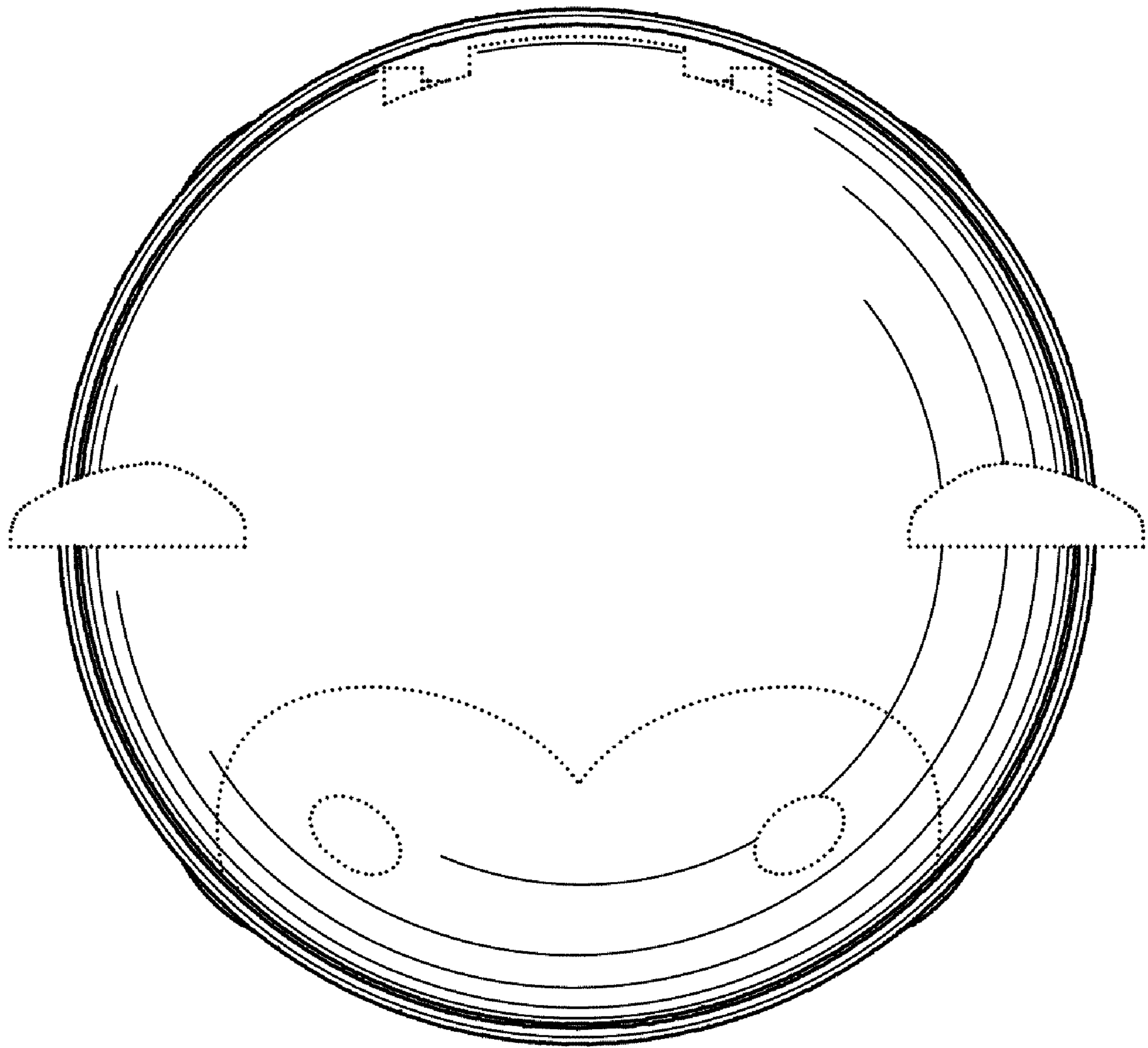
*Fig. 3*



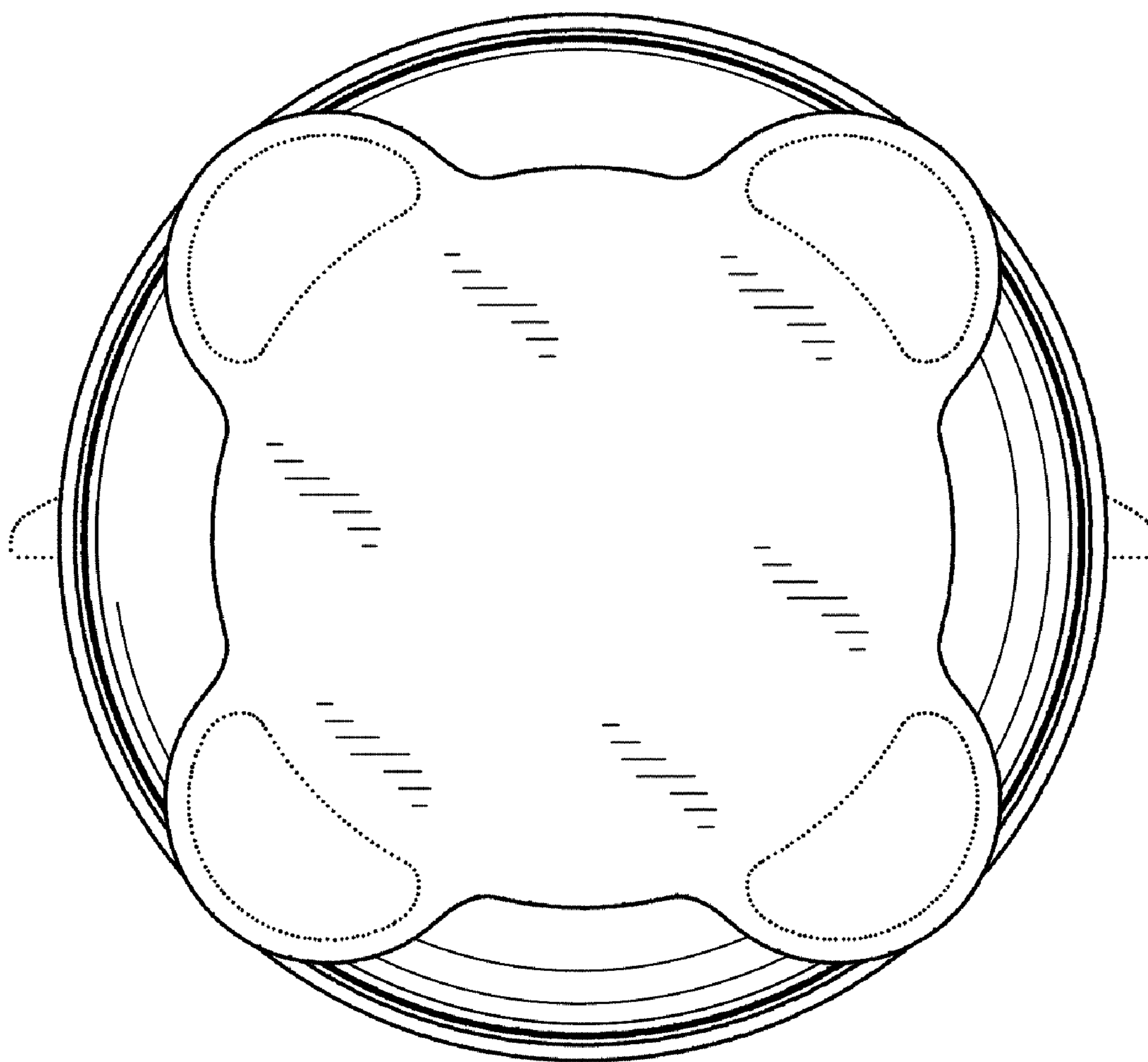
*Fig. 4*



*Fig. 5*

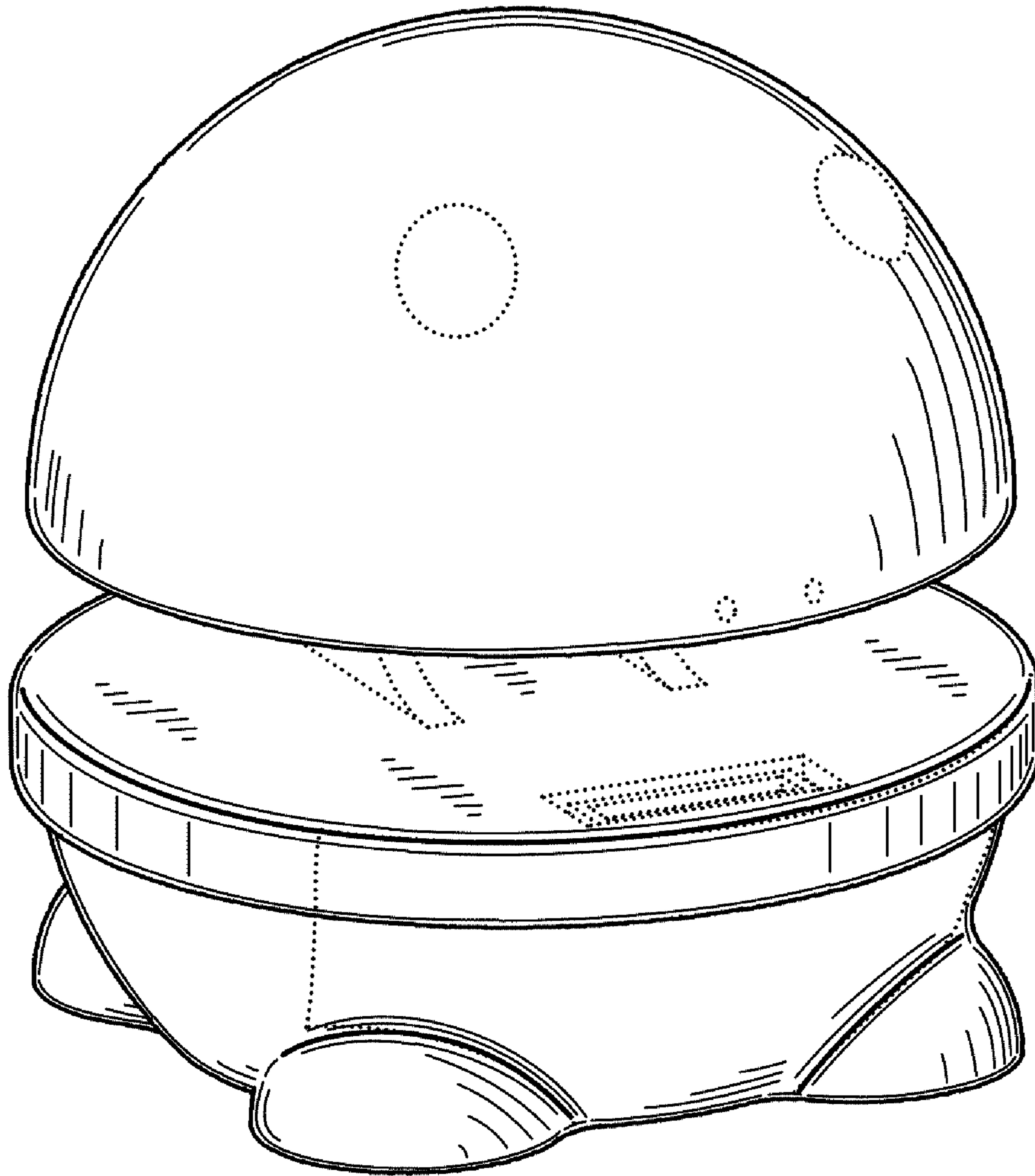


*Fig. 6*

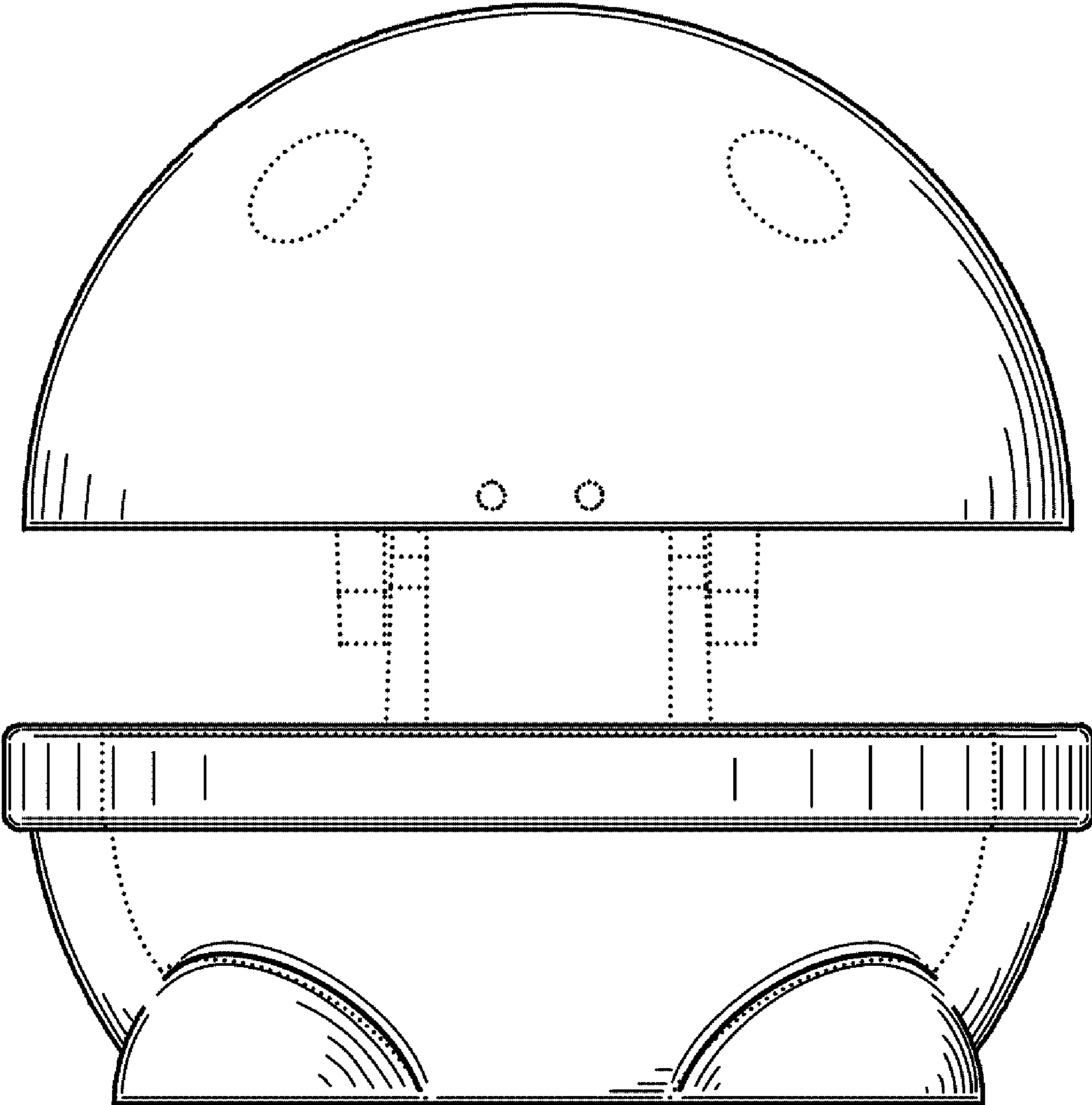


*Fig. 7*

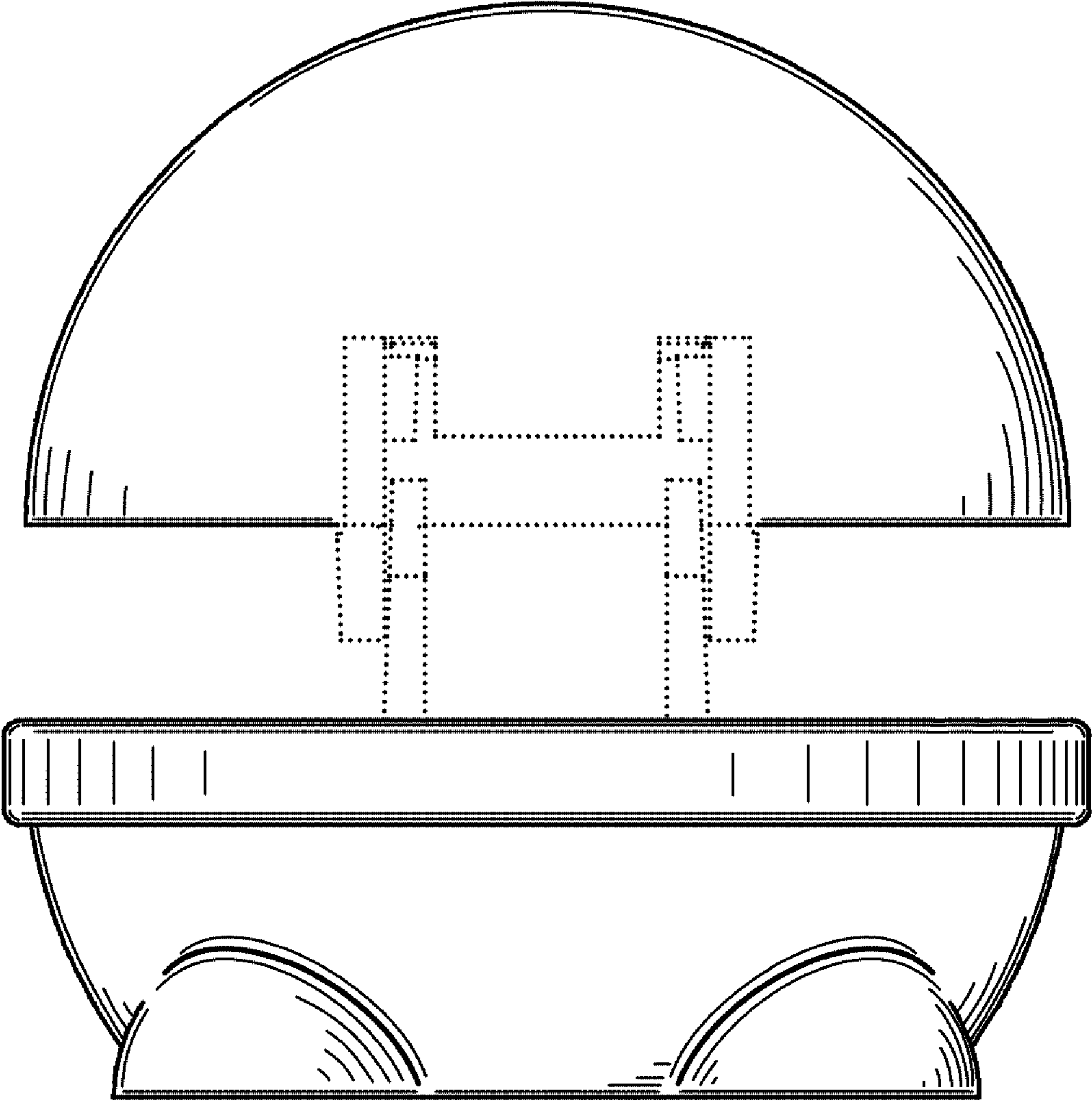




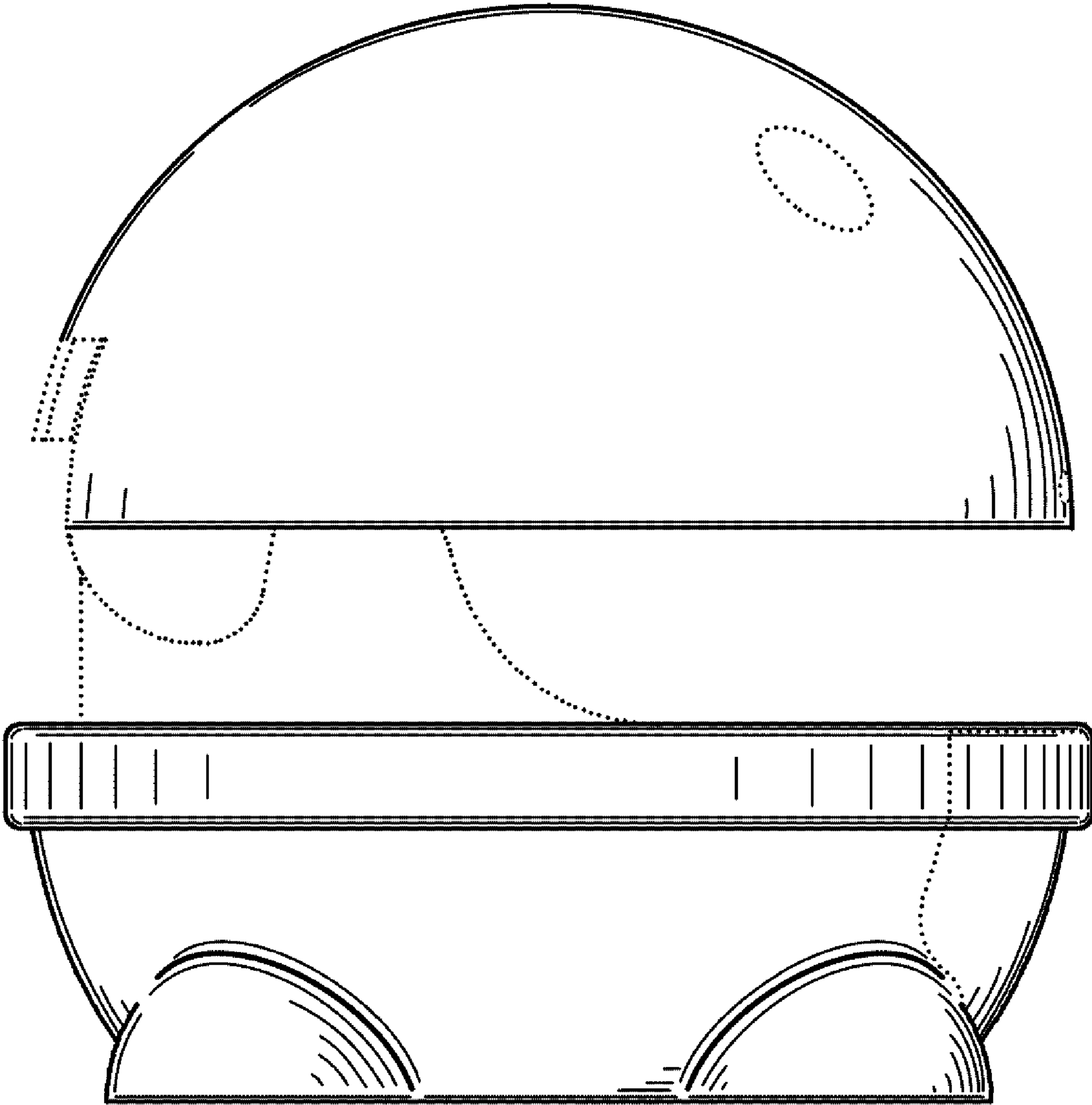
*Fig. 8*



*Fig. 9*

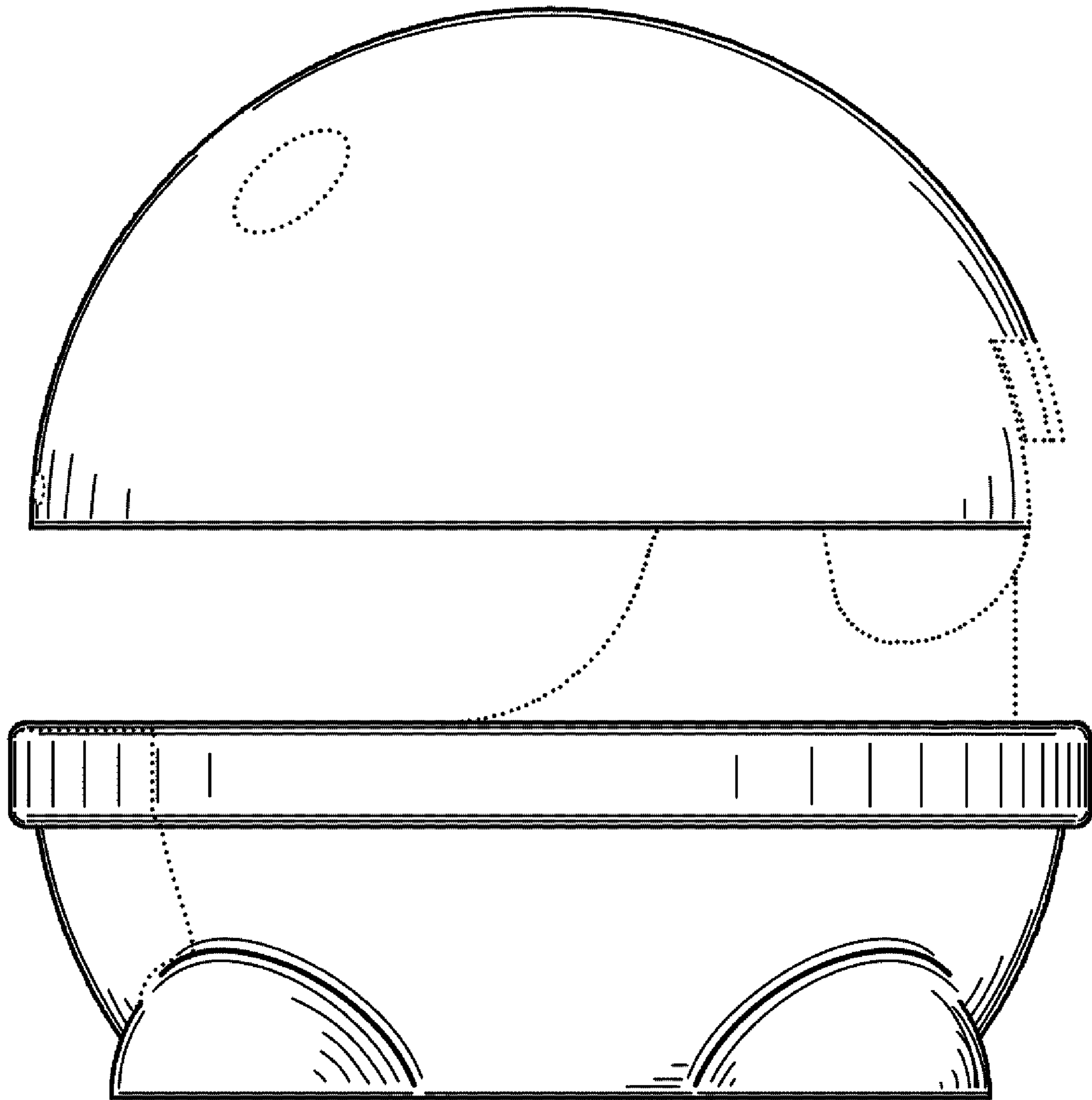


*Fig. 10*

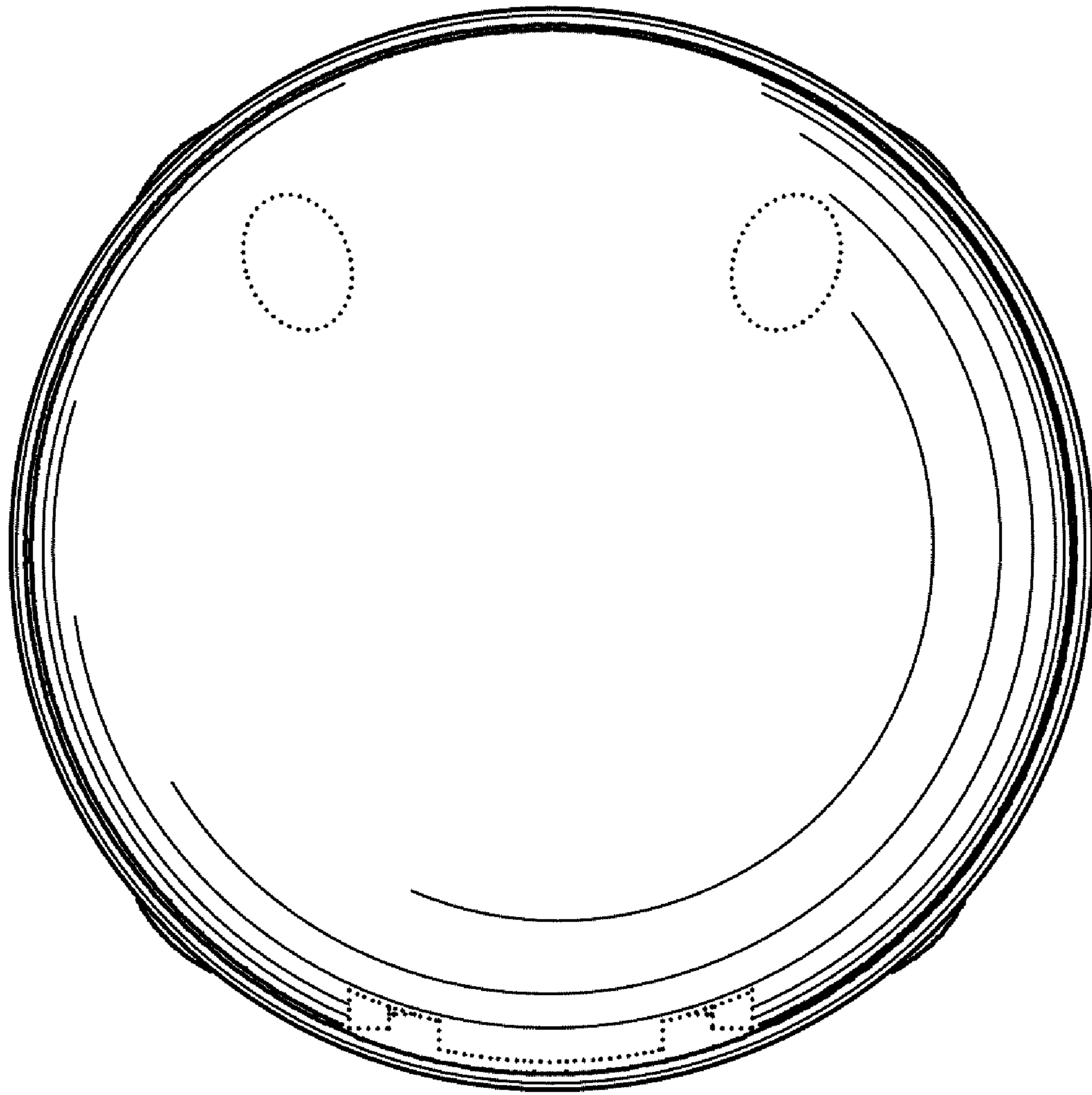


*Fig. 11*

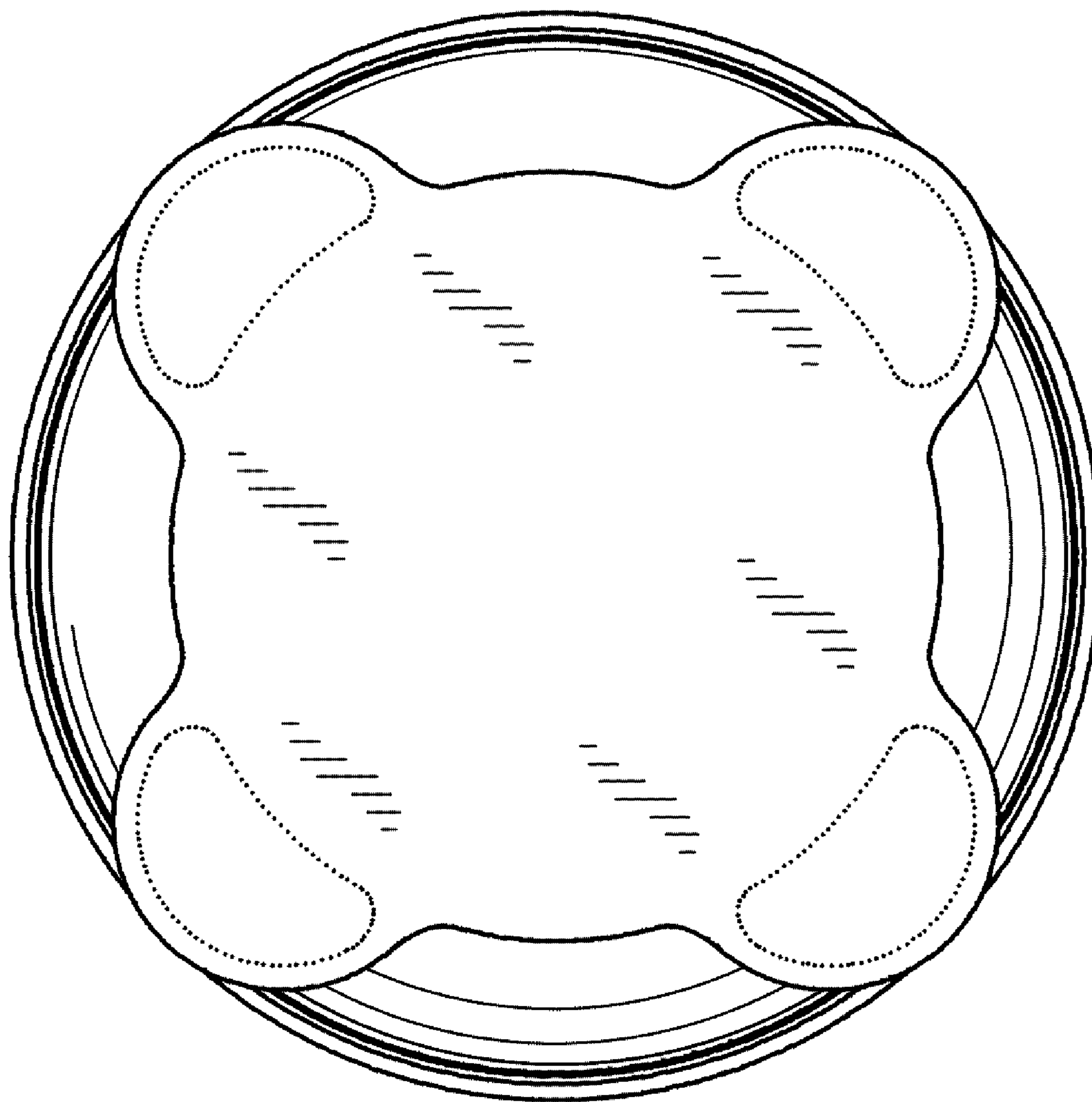




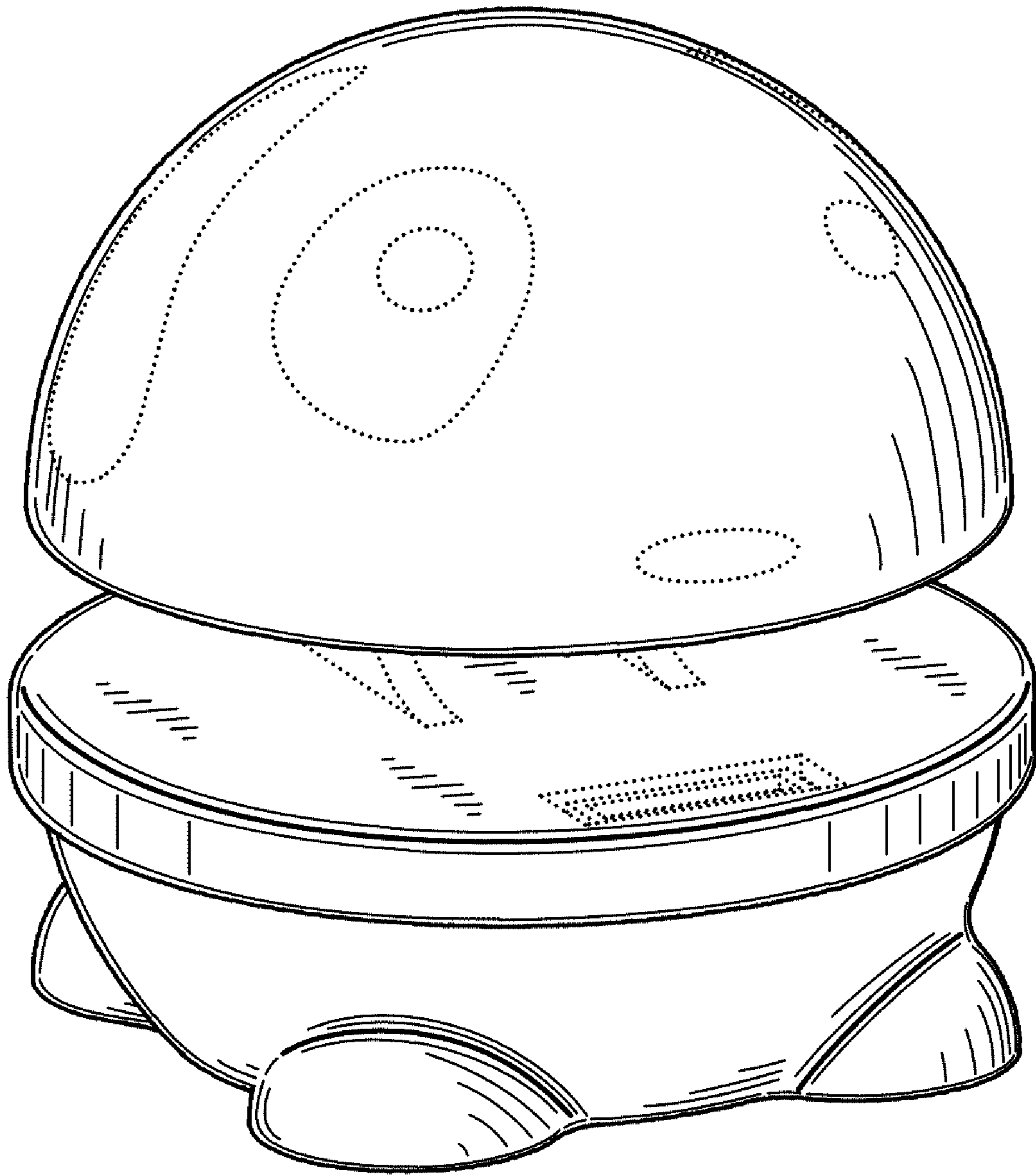
*Fig. 12*



*Fig. 13*

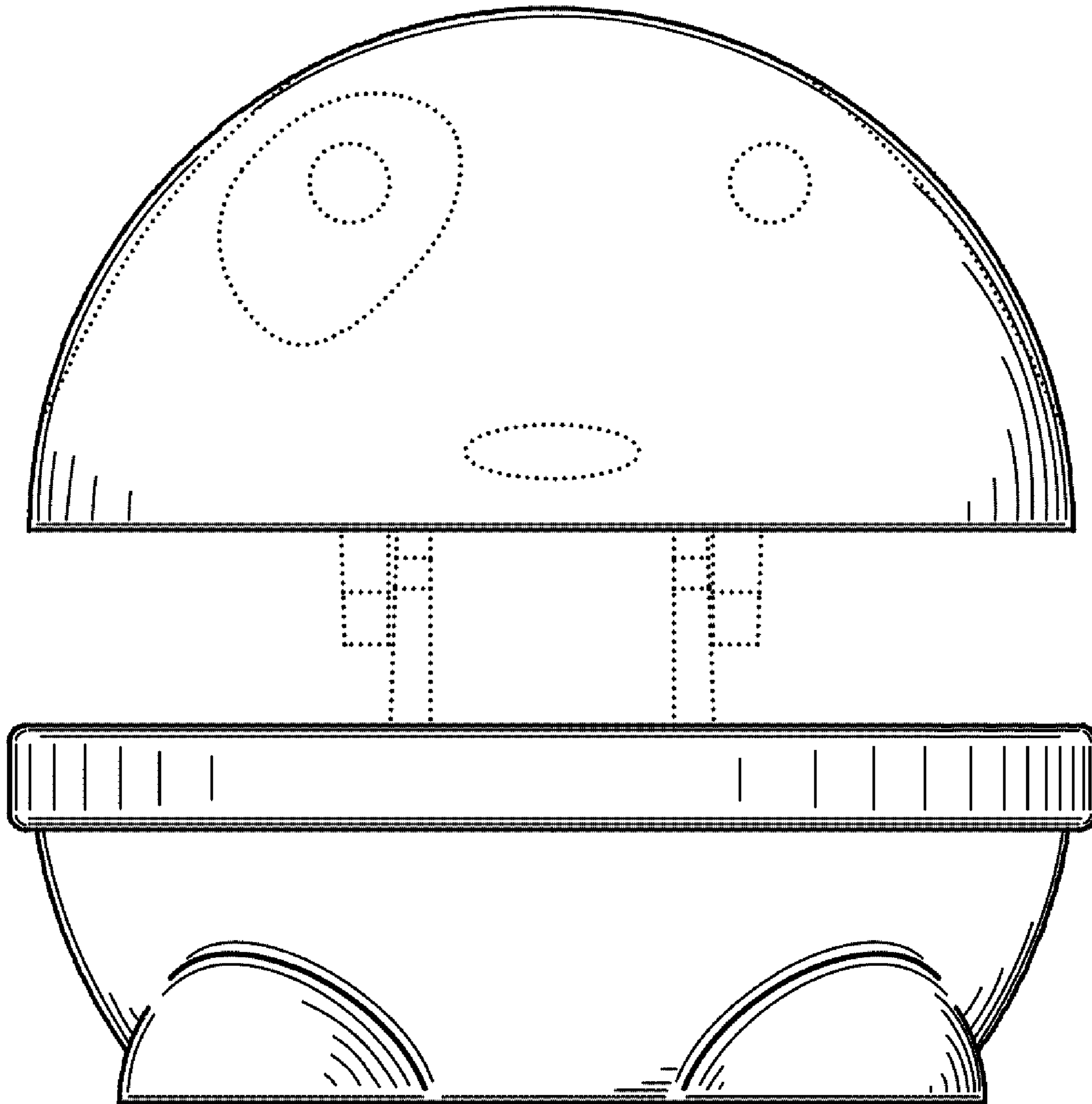


*Fig. 14*

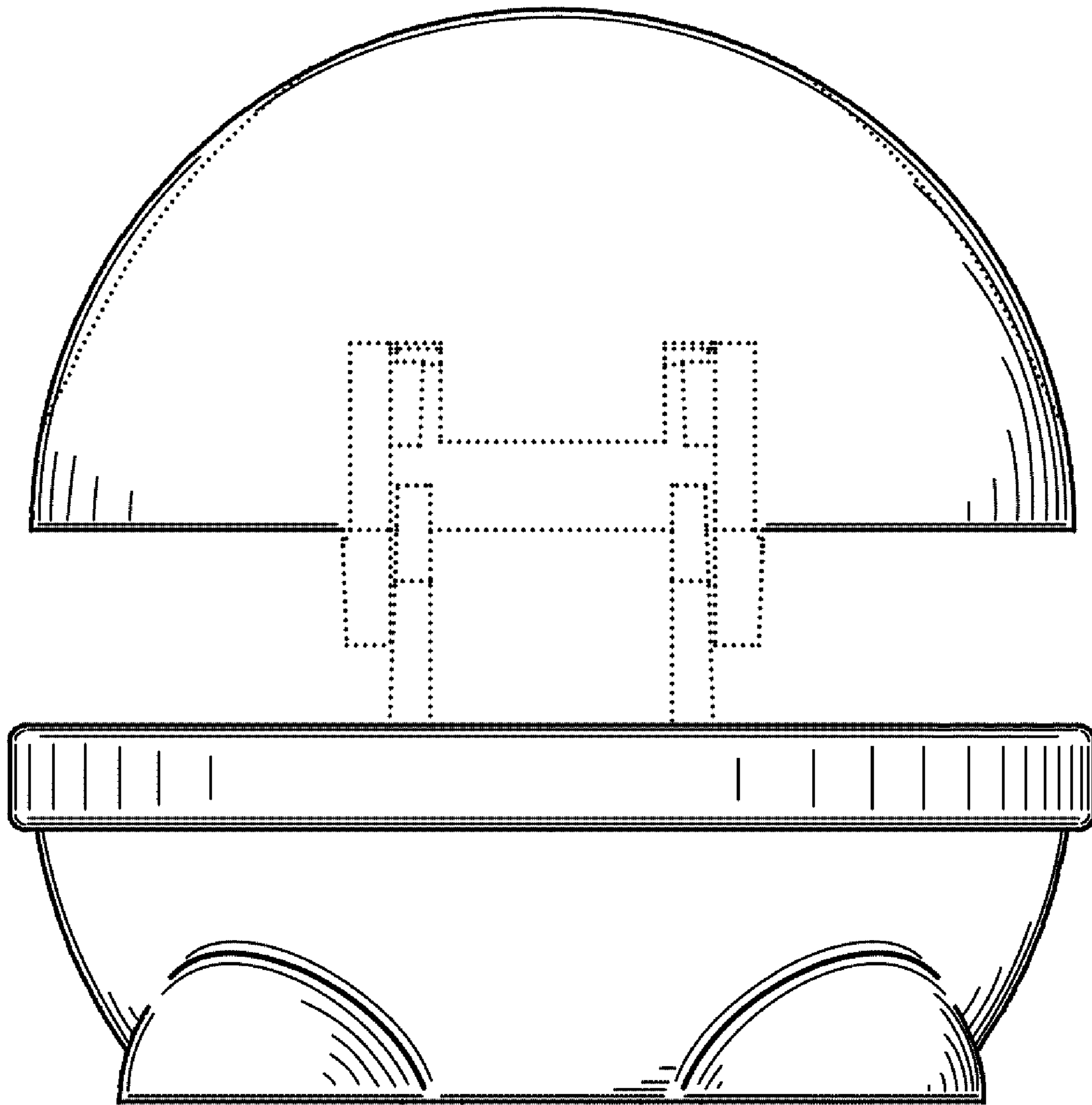


***Fig. 15***

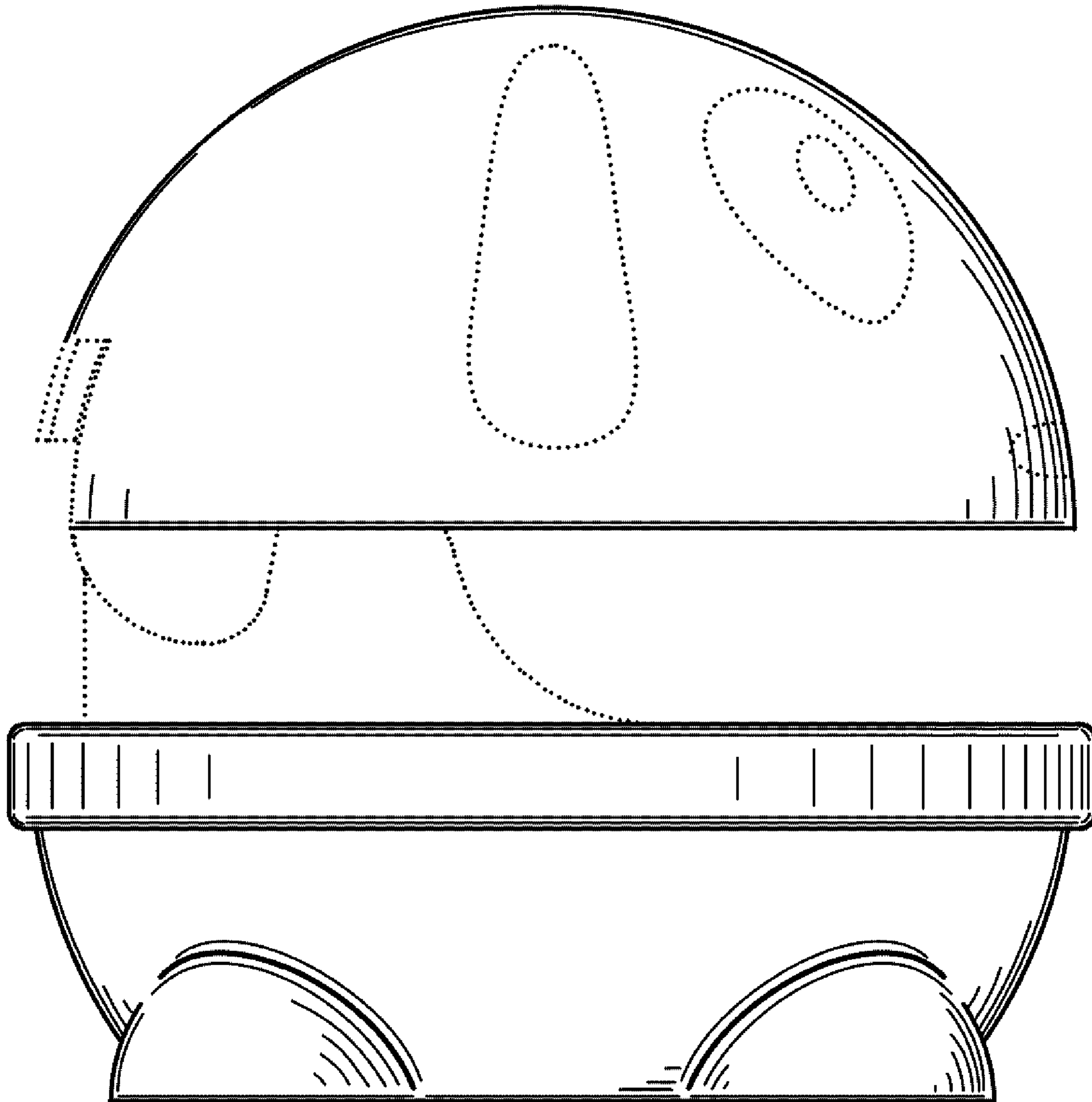




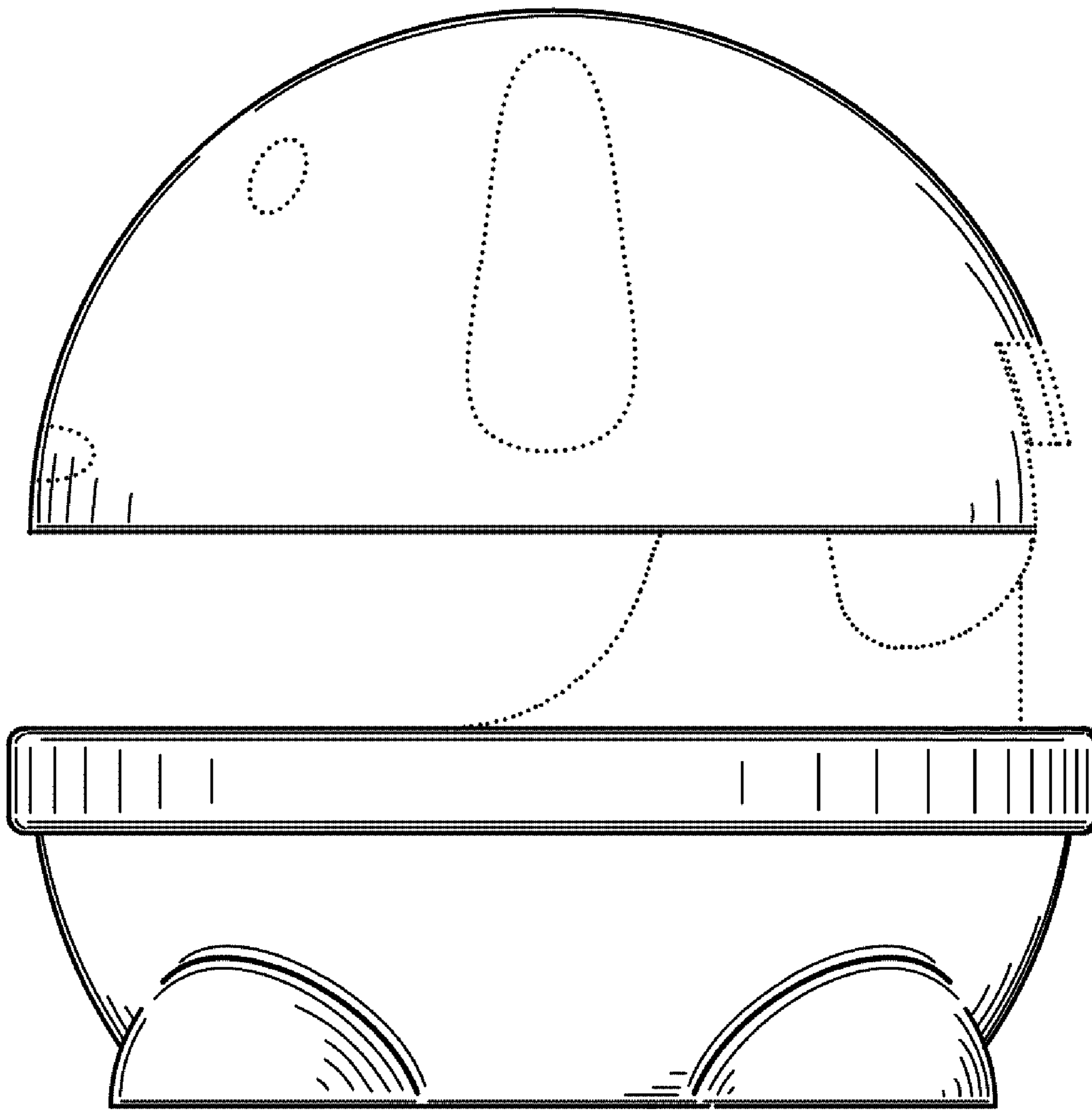
*Fig. 16*



*Fig. 17*

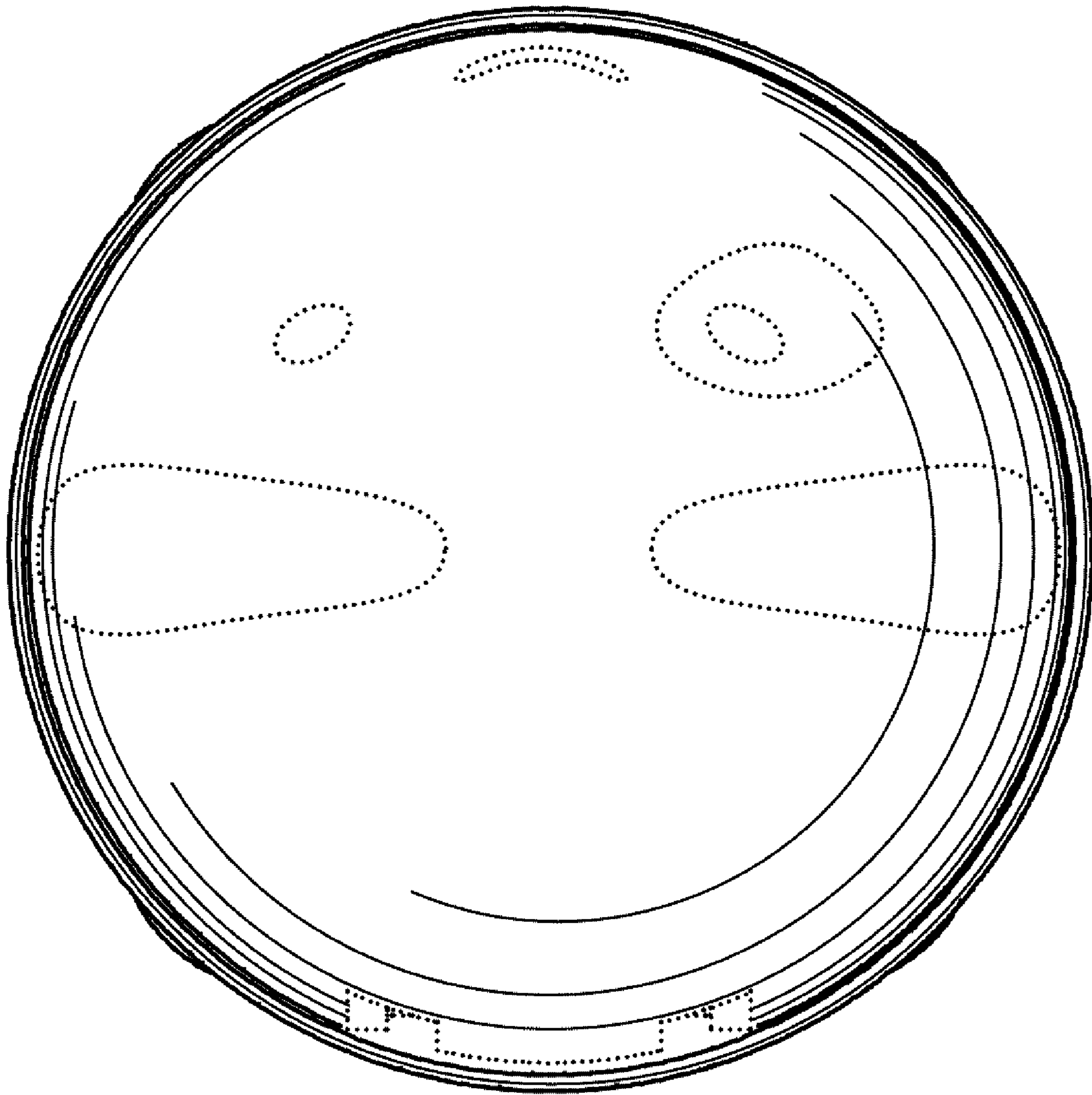


*Fig. 18*

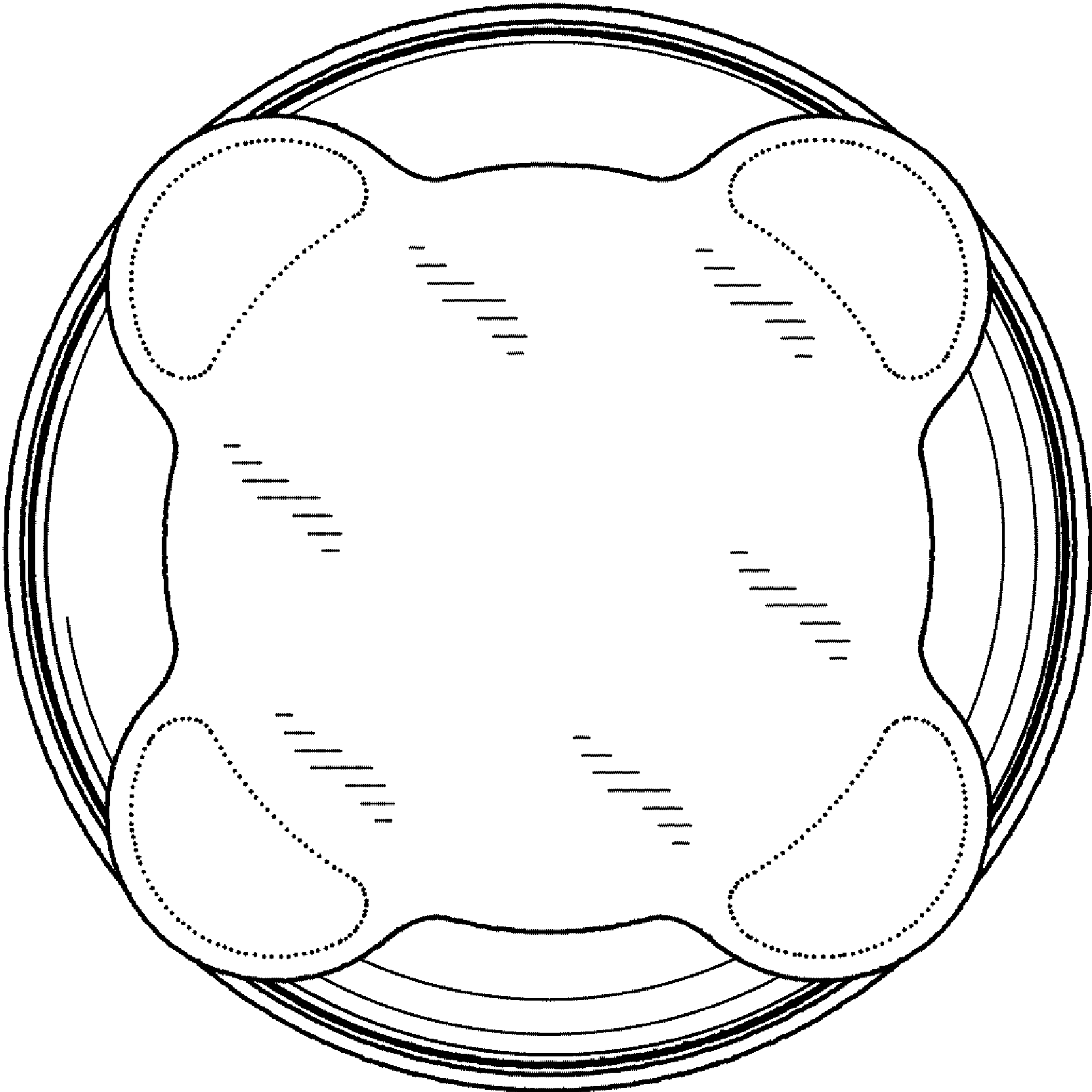


*Fig. 19*





*Fig. 20*



*Fig. 21*