



US00D651051S

(12) **United States Design Patent**  
**Wellman**

(10) **Patent No.:** **US D651,051 S**  
(45) **Date of Patent:** **\*\* Dec. 27, 2011**

(54) **DEVICE FOR PREPARING A FOOD**

D630,912 S \* 1/2011 Wong ..... D7/693

\* cited by examiner

(75) Inventor: **Craig Wellman**, Ingleburn (AU)

*Primary Examiner* — Terry Wallace

(73) Assignee: **Peter Sfakianakis**, Peakhurst, NSW (AU)

(74) *Attorney, Agent, or Firm* — Occhiuti Rohlicek & Tsao LLP

(\*\*) Term: **14 Years**

(57) **CLAIM**

(21) Appl. No.: **29/361,215**

The ornamental design for a device for preparing a food, as shown.

(22) Filed: **May 7, 2010**

(51) **LOC (9) Cl.** ..... **07-04**

**DESCRIPTION**

(52) **U.S. Cl.** ..... **D7/679; D7/372**

(58) **Field of Classification Search** ..... D7/679,  
D7/678, 693, 368, 669, 372; 99/584, 586;  
241/168, 169.1

FIG. 1 is a top perspective view of the design for a device for preparing a food.

FIG. 2 is a bottom perspective view thereof.

FIG. 3 is a top view thereof.

FIG. 4 is a bottom view thereof.

FIG. 5 is a first side view thereof, along the direction indicated by the arrow labeled "5" in FIG. 3; and,

FIG. 6 is a second side view thereof, along the direction indicated by the arrow labeled "6" in FIG. 3.

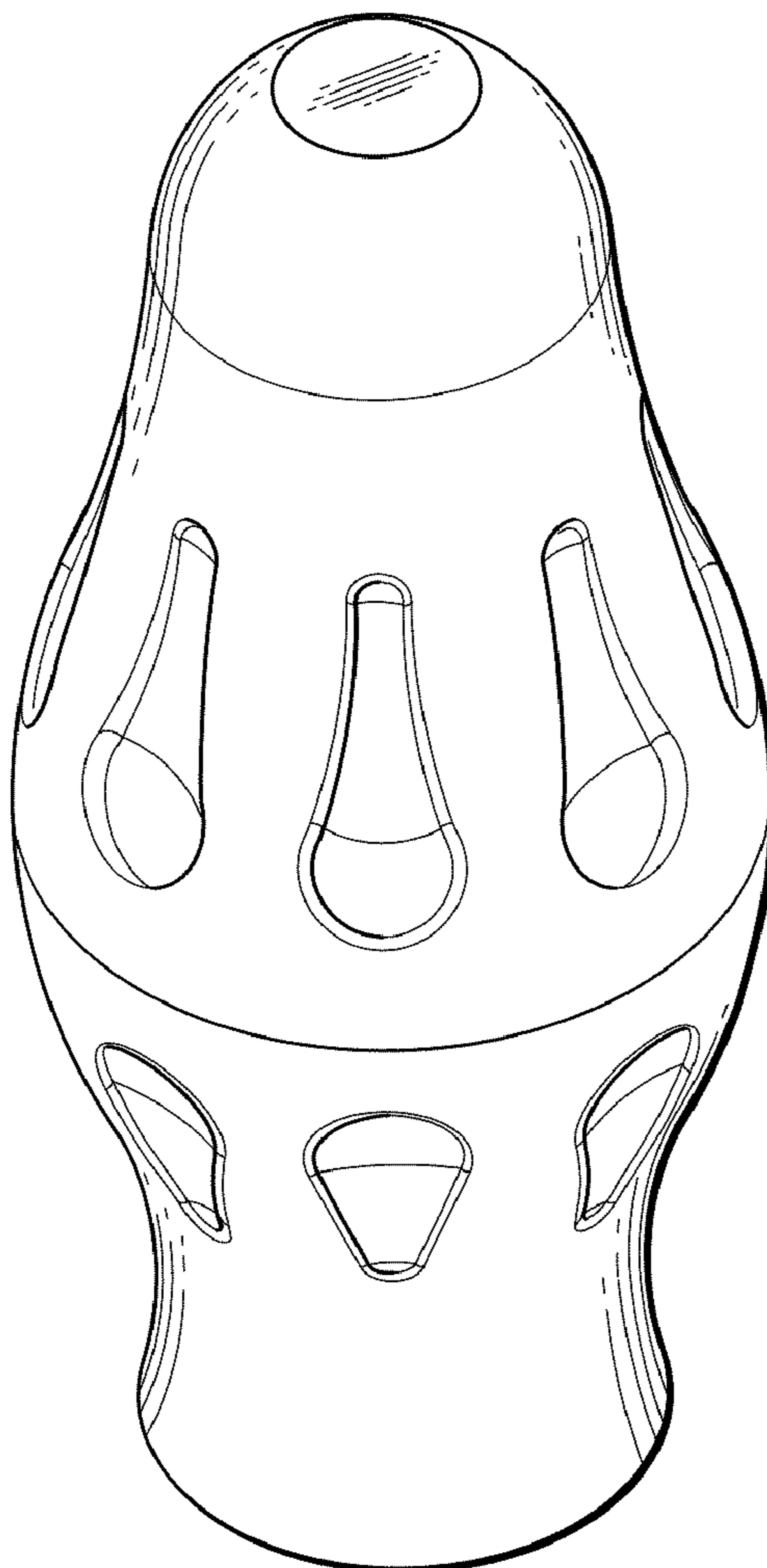
See application file for complete search history.

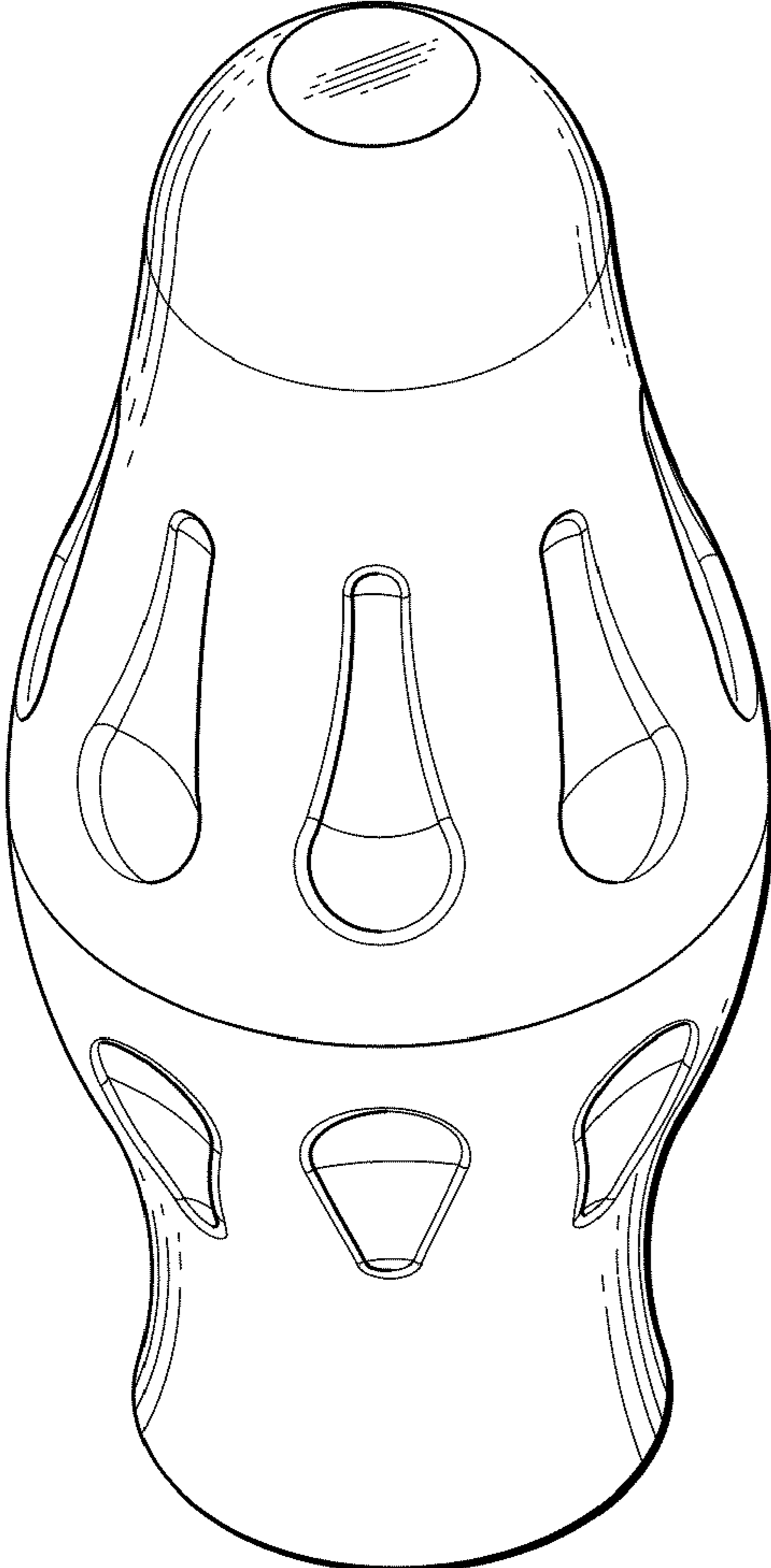
(56) **References Cited**

**U.S. PATENT DOCUMENTS**

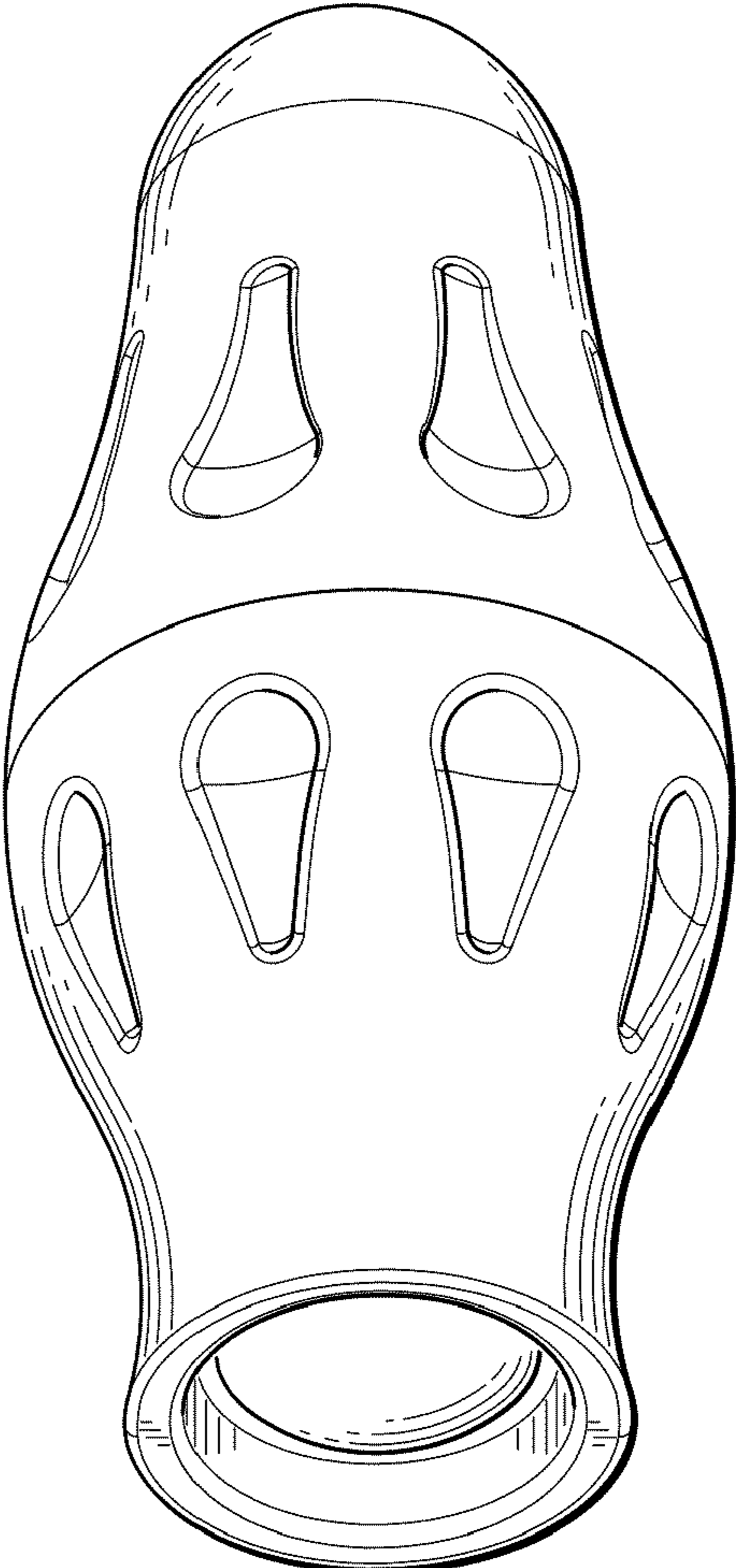
5,573,803	A *	11/1996	Omessi	.....	426/483
D414,660	S *	10/1999	Hints	.....	D7/679
7,422,169	B2 *	9/2008	Mueller	.....	241/168

**1 Claim, 2 Drawing Sheets**

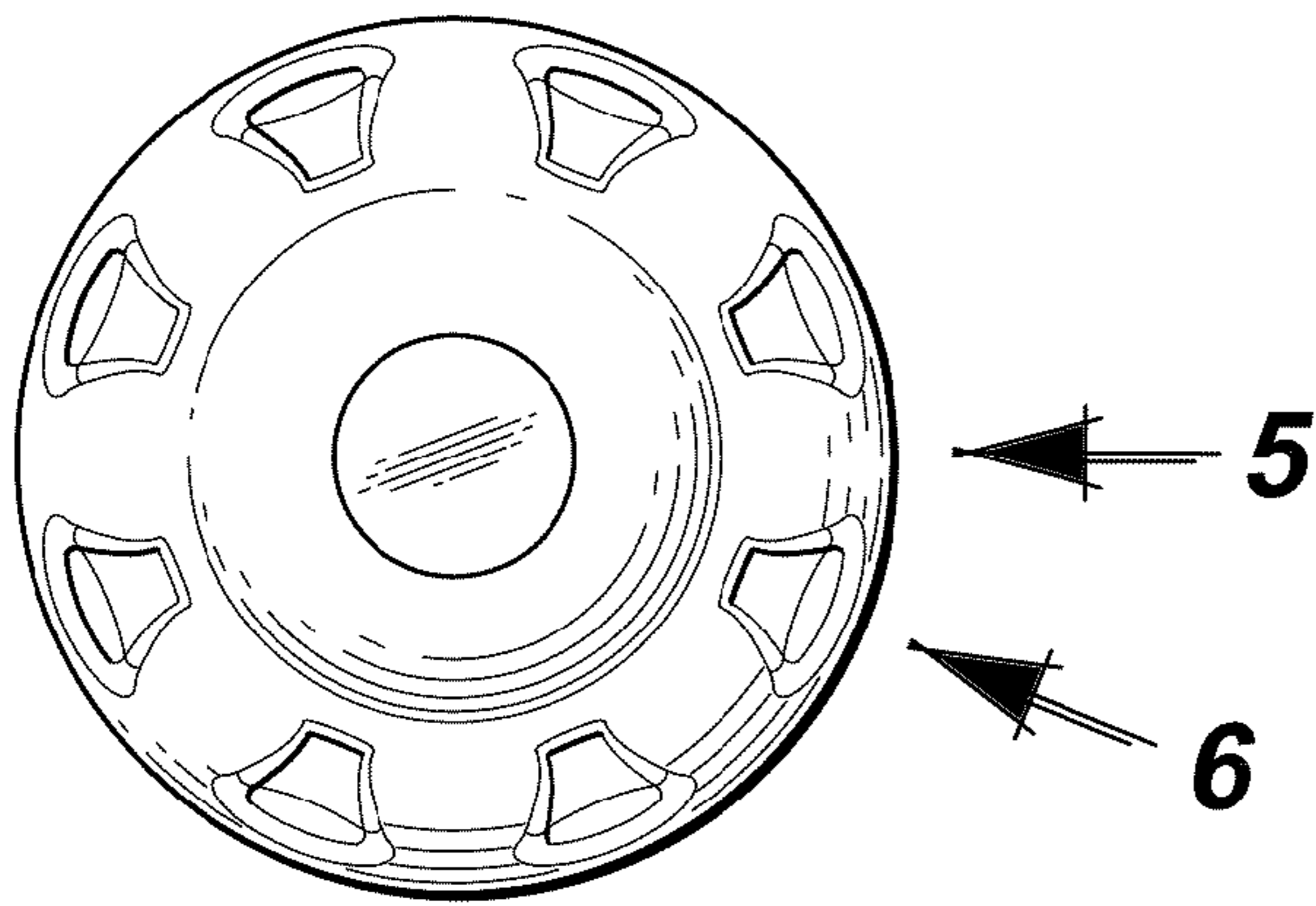




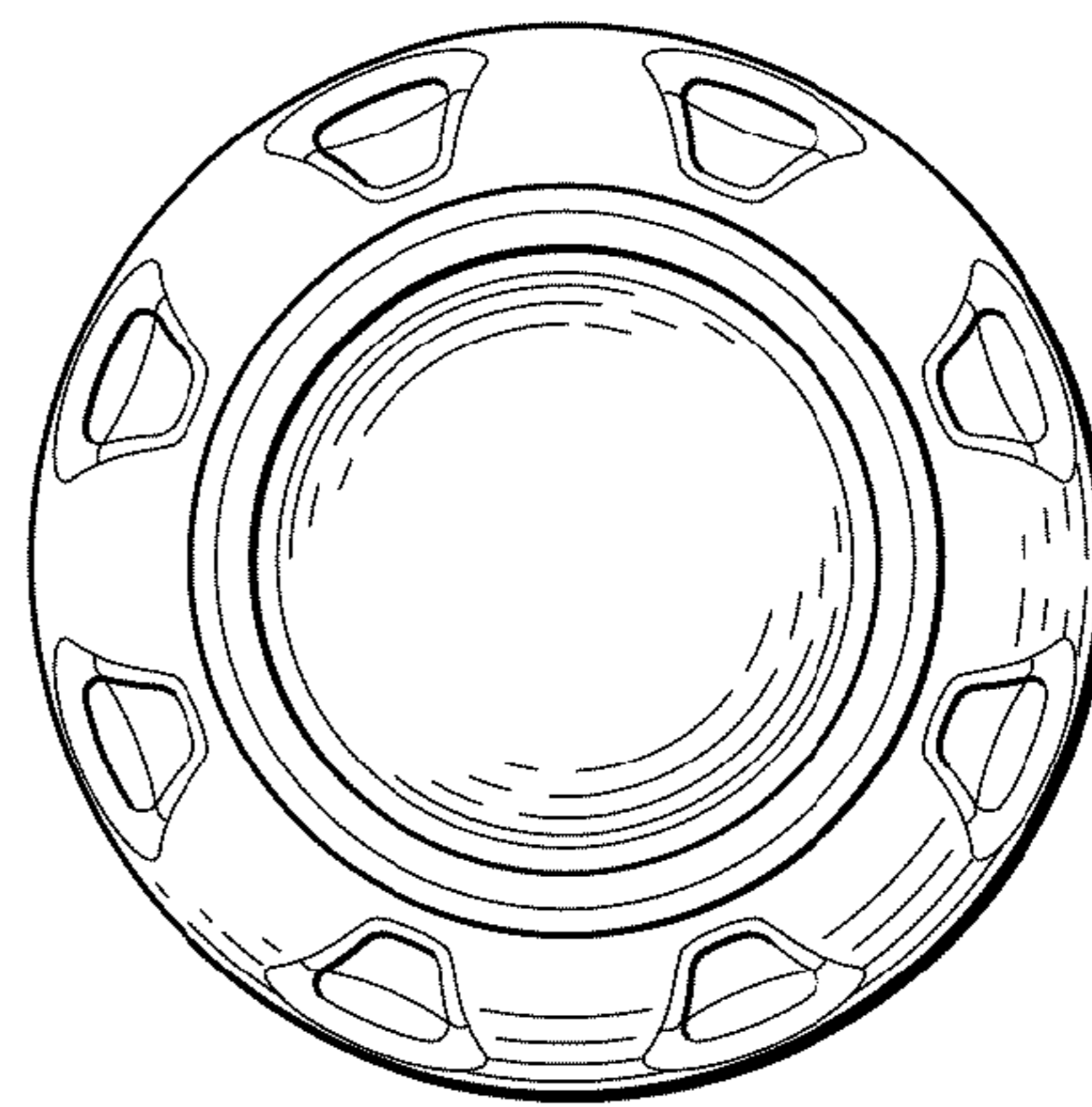
**FIG. 1**



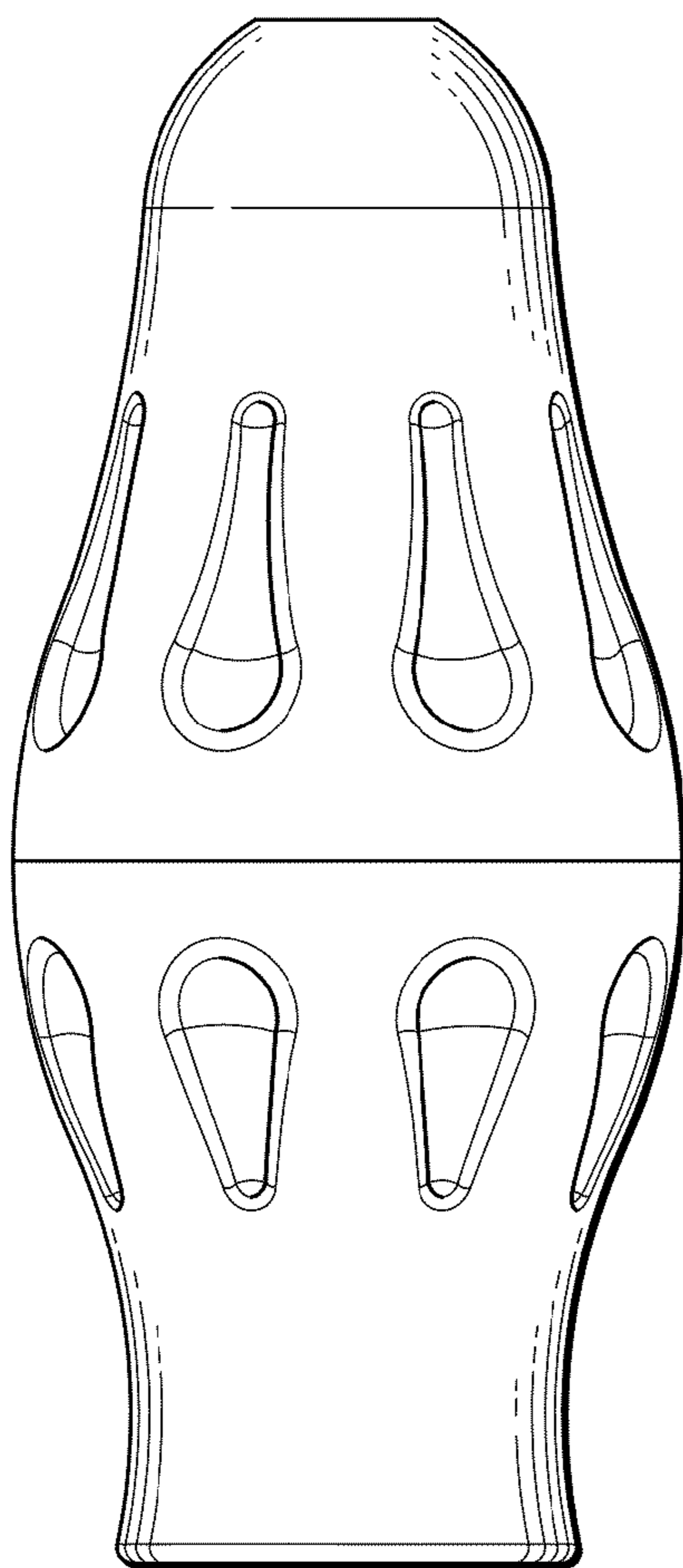
**FIG. 2**



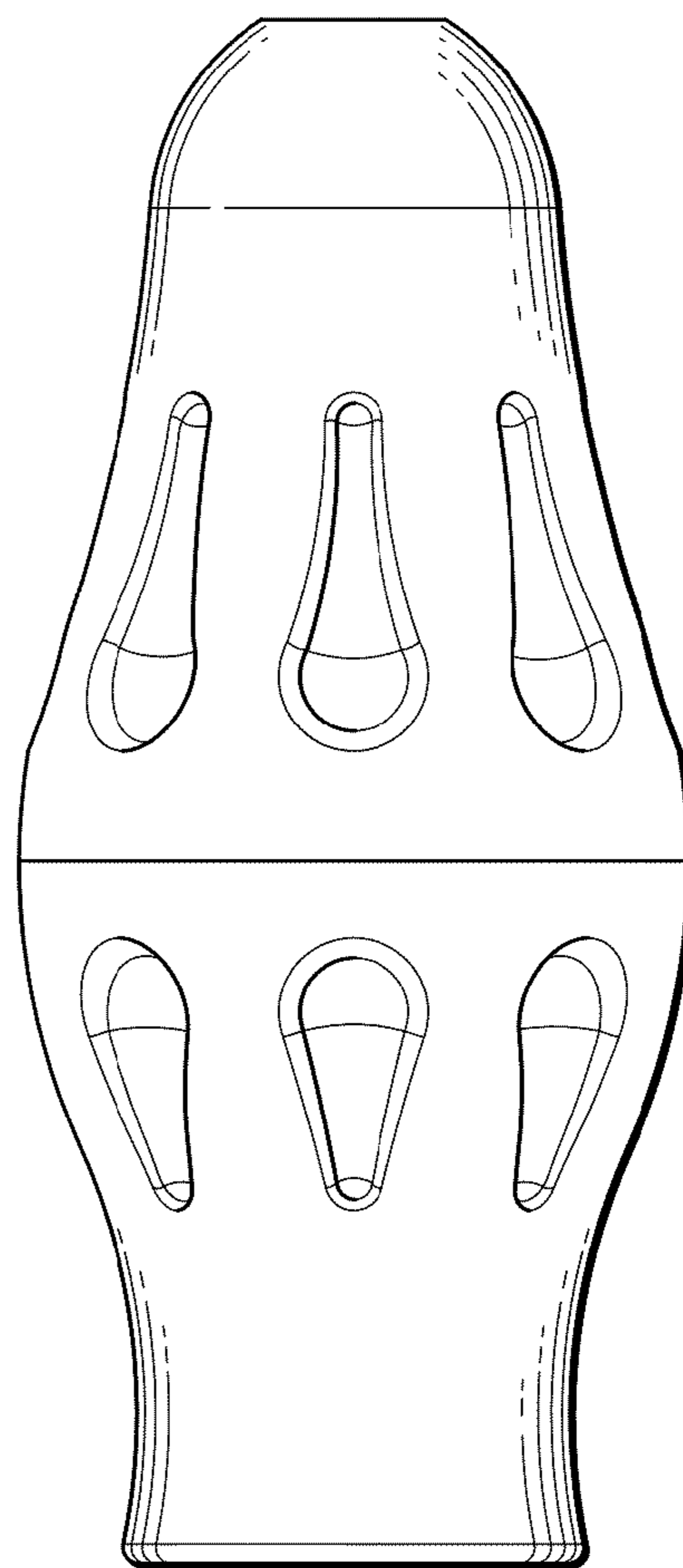
**FIG. 3**



**FIG. 4**



**FIG. 5**



**FIG. 6**