



US00D650959S

(12) **United States Design Patent**  
**Gilbride et al.**

(10) **Patent No.:** **US D650,959 S**

(45) **Date of Patent:** **\*\* Dec. 20, 2011**

(54) **MAST FOR A MATERIAL HANDLING VEHICLE**

(75) Inventors: **Matthew I. Gilbride**, Raleigh, NC (US);  
**Gregory W. Smiley**, Greene, NY (US)

(73) Assignee: **The Raymond Corporation**, Greene,  
NY (US)

(\*\*) Term: **14 Years**

(21) Appl. No.: **29/387,858**

(22) Filed: **Mar. 18, 2011**

(51) **LOC (9) Cl.** ..... **12-05**

(52) **U.S. Cl.** ..... **D34/35; D34/34**

(58) **Field of Classification Search** ..... D34/34,  
D34/35; 180/89.12, 89.13, 89.17; 187/222,  
187/237

See application file for complete search history.

(56) **References Cited**

U.S. PATENT DOCUMENTS

RE30,815 E \* 12/1981 Kelley, Jr. .... 187/230  
D353,931 S \* 12/1994 Kobayakawa et al. .... D34/34

D562,525 S \* 2/2008 Graf et al. .... D34/34  
2005/0016782 A1 \* 1/2005 Gallagher et al. .... 180/89.12  
2011/0162912 A1 \* 7/2011 Rainsford ..... 187/222

\* cited by examiner

*Primary Examiner* — Cynthia Ramirez

(74) *Attorney, Agent, or Firm* — Quarles & Brady LLP

(57) **CLAIM**

The ornamental design for a mast for a material handling vehicle, as shown and described.

**DESCRIPTION**

FIG. 1 is a top, right, rear perspective view of a mast embodying our new design coupled to a material handling vehicle; FIG. 2 is a top, right, rear perspective view of the mast of FIG. 1 removed from the material handling vehicle; FIG. 3 is a rear elevational view thereof; FIG. 4 is a front elevational view thereof; FIG. 5 is a right elevational view thereof, the left elevational view being a mirror image thereof; FIG. 6 is a top plan view thereof; and, FIG. 7 is a bottom plan view thereof.

The broken line representations in the views are for illustrative purposes only and form no part of the claimed design.

**1 Claim, 6 Drawing Sheets**

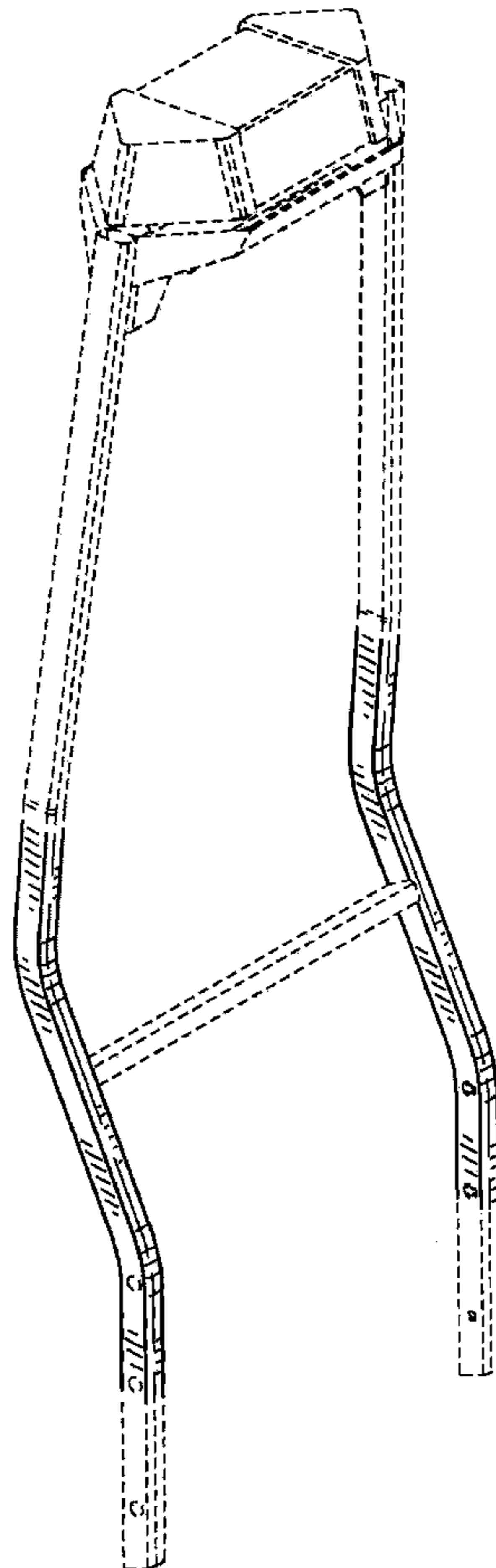

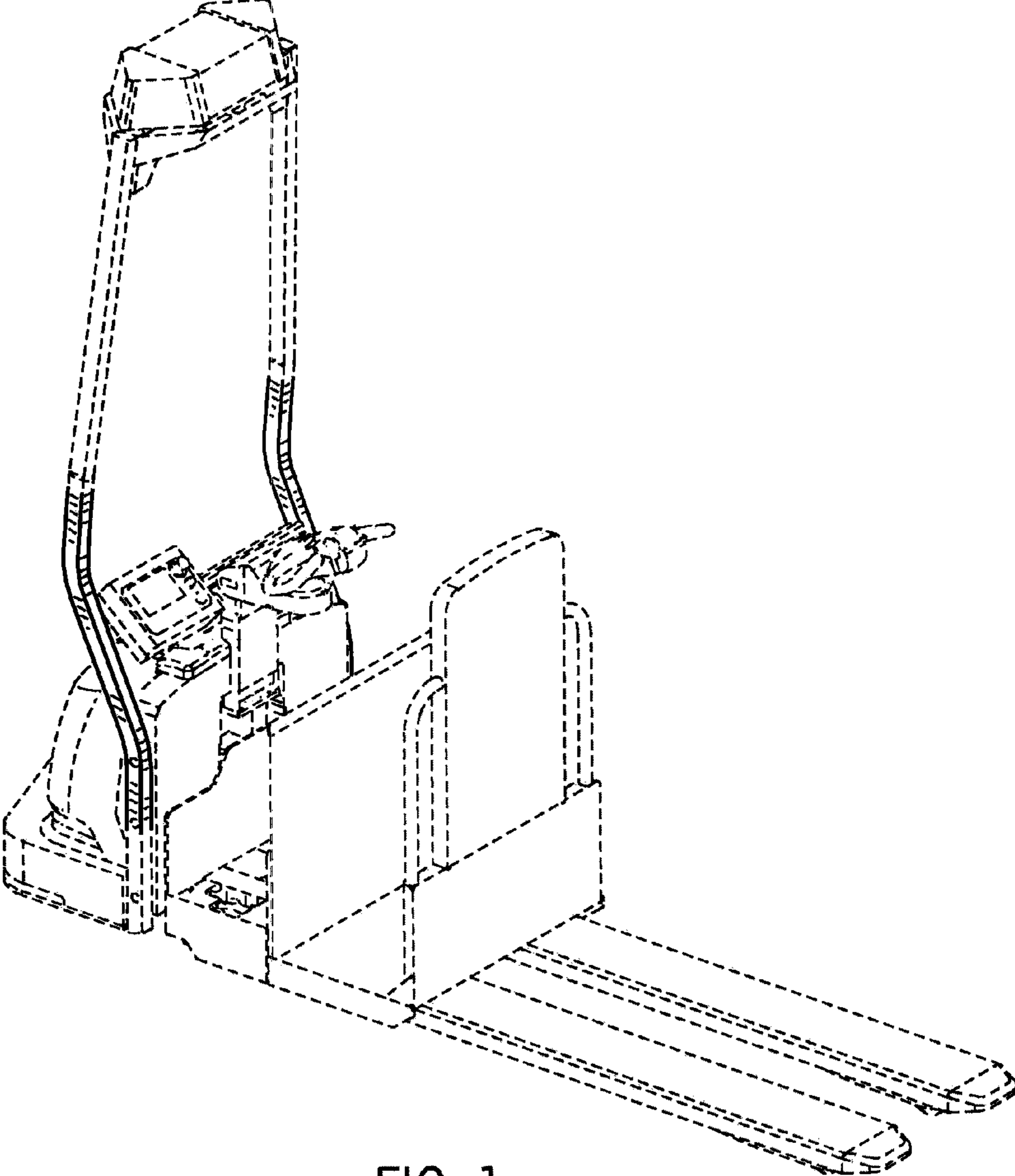

FIG. 1

FIG. 2

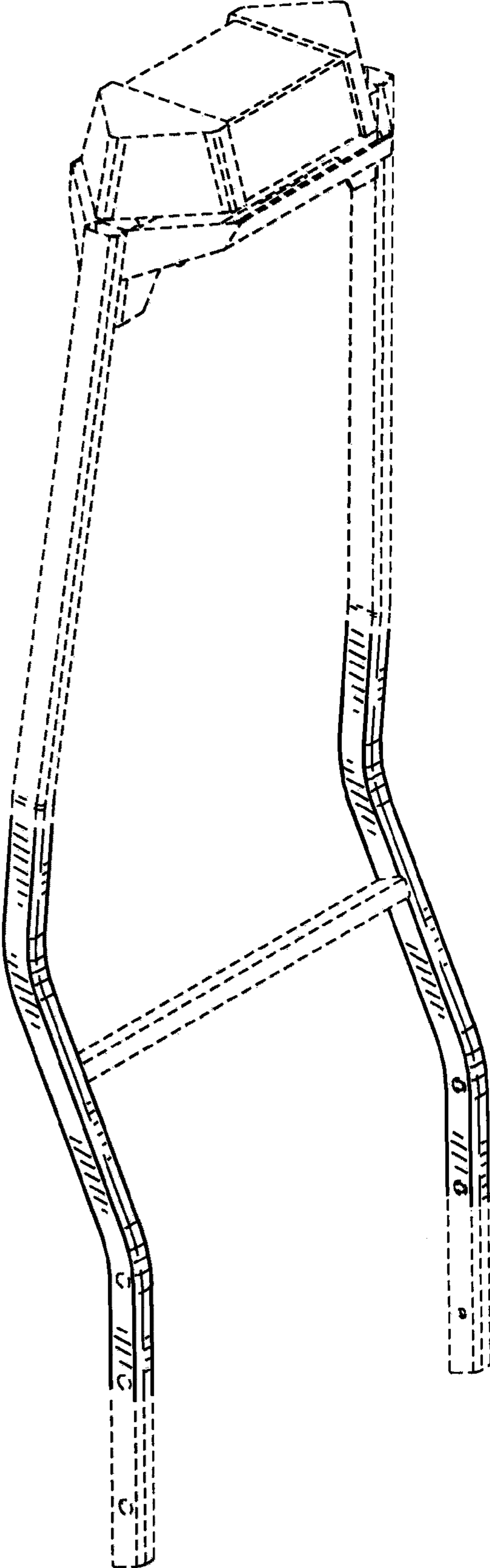

FIG. 3

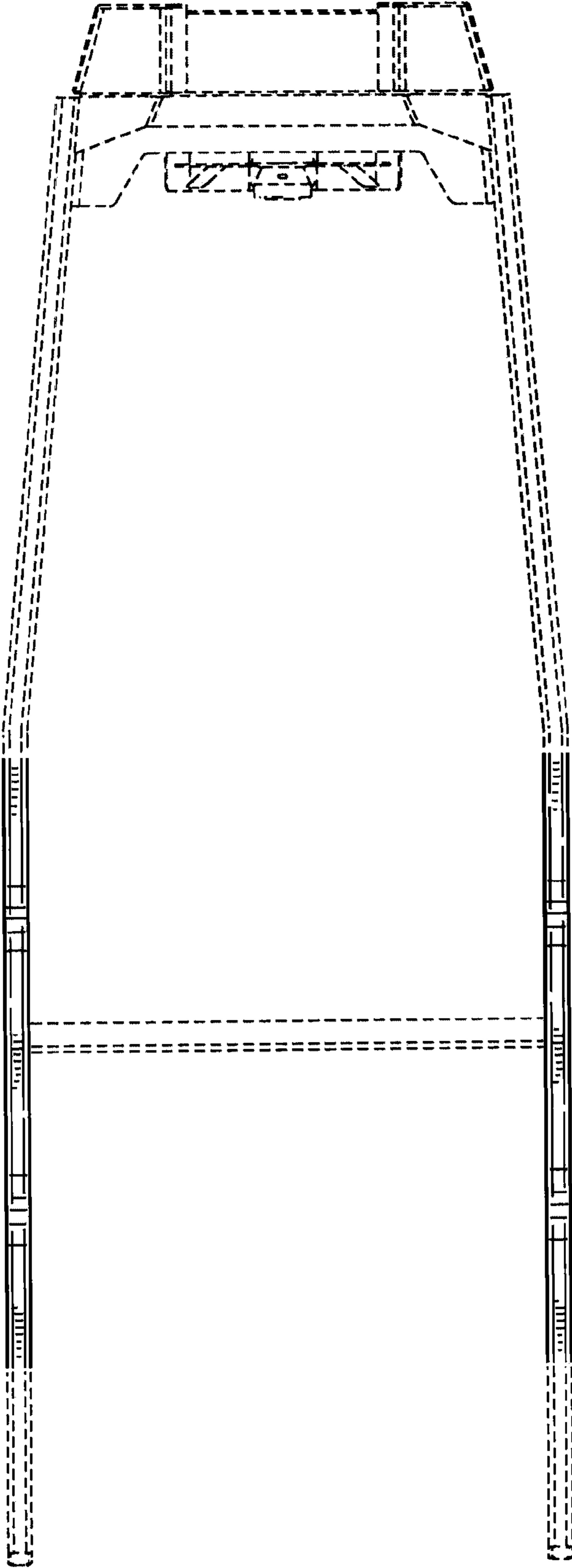
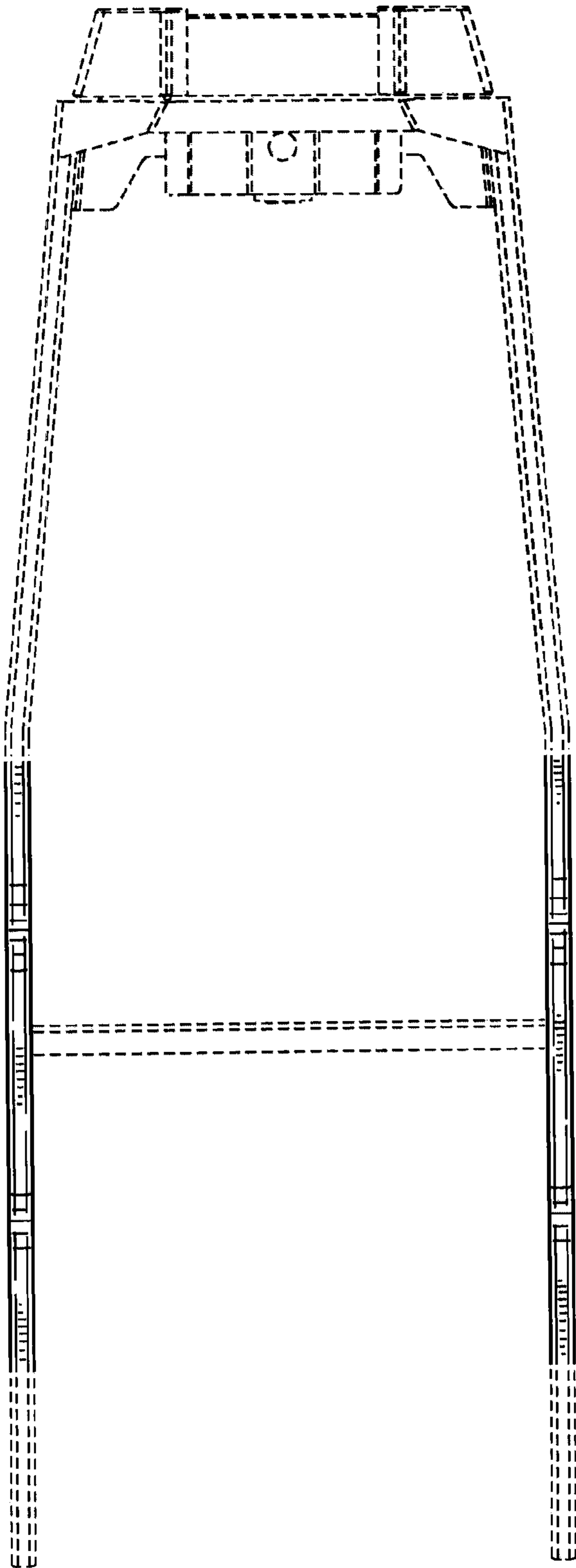

FIG. 4



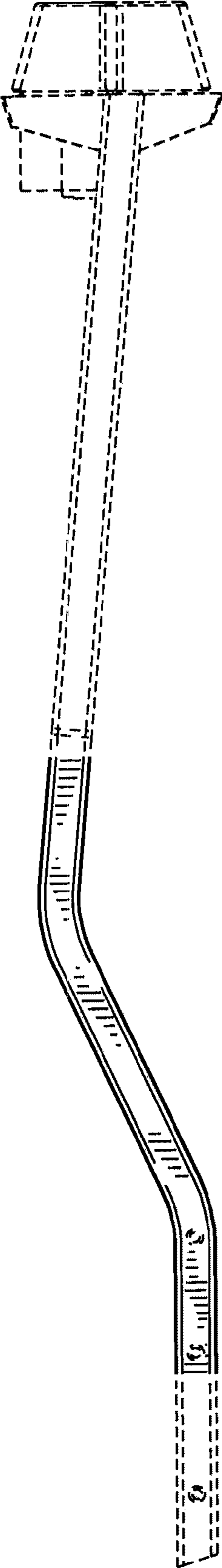

FIG. 5

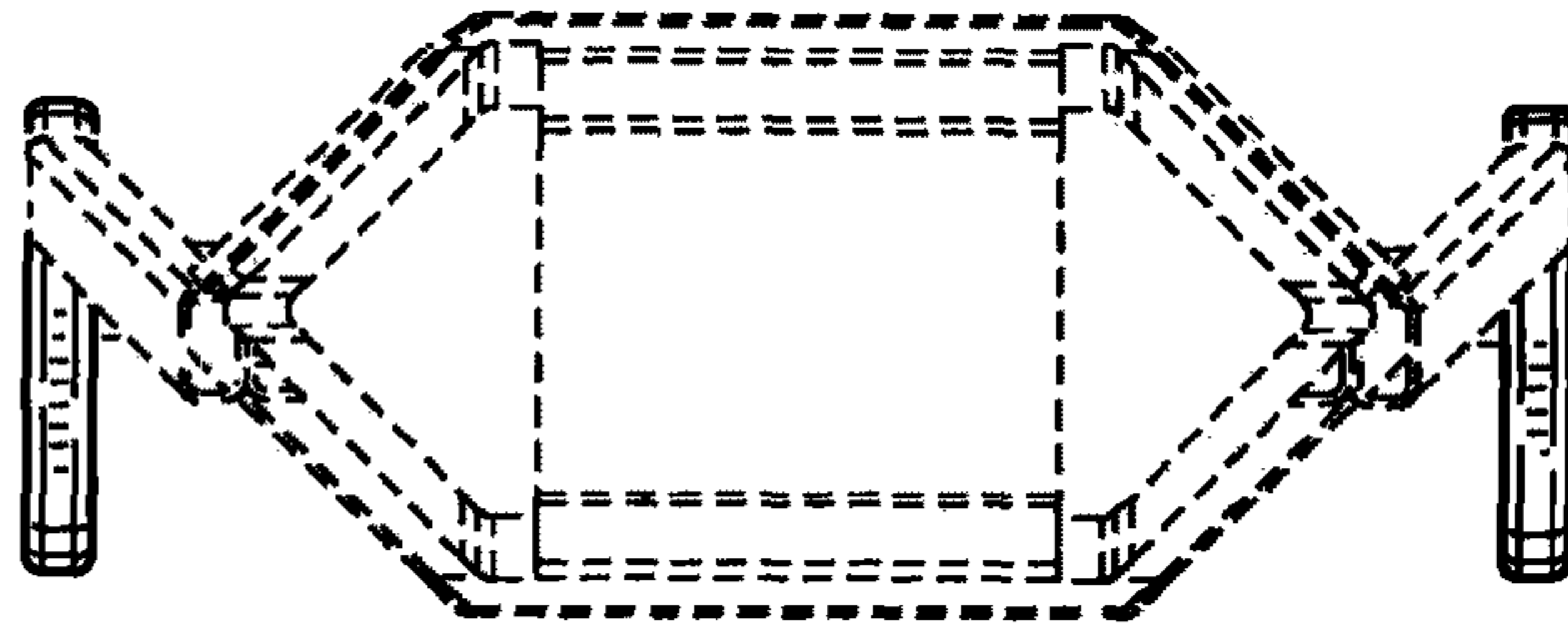

FIG. 6

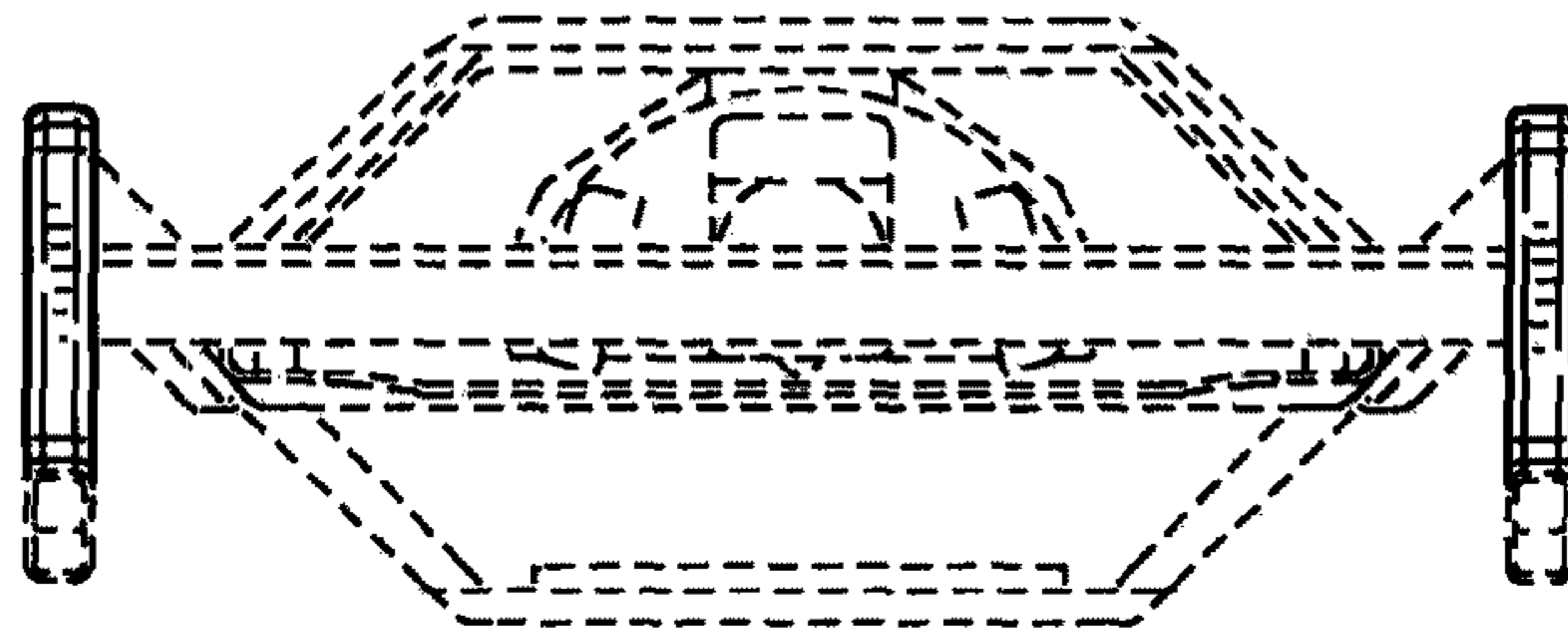

FIG. 7