



US00D650923S

(12) **United States Design Patent**
Hudson, Jr. et al.

(10) **Patent No.:** **US D650,923 S**

(45) **Date of Patent:** **** Dec. 20, 2011**

(54) **SHINGLE ROOF PANEL**

(75) Inventors: **Willard C. Hudson, Jr.**, Southlake, TX (US); **James F. Sauter**, Cleburne, TX (US); **Kevin B. Pelka**, Arlington, TX (US); **Geoffrey S. Allan**, Arlington, TX (US); **Peter B. Richards**, Arlington (NZ); **David R. Painter**, North Shore Auckland (NZ)

(73) Assignee: **Decra Roofing Systems, Inc.**, Arlington, TX (US)

(**) Term: **14 Years**

(21) Appl. No.: **29/397,302**

(22) Filed: **Jul. 14, 2011**

Related U.S. Application Data

(62) Division of application No. 29/379,314, filed on Nov. 17, 2010, now Pat. No. Des. 644,755.

(51) **LOC (9) Cl.** **25-01**

(52) **U.S. Cl.** **D25/140; D25/139**

(58) **Field of Classification Search** D25/140, D25/139; 52/519, 526, 518, 536, 539, 541, 52/544; 126/621, 622, 623

See application file for complete search history.

(56) **References Cited**

U.S. PATENT DOCUMENTS

734,976	A	7/1903	Simmerman
3,114,218	A	12/1963	Macquere
4,204,520	A	5/1980	Rosenberg
4,244,355	A	1/1981	Stout
4,606,164	A	8/1986	Mendez
4,731,969	A	3/1988	Baker et al.
D331,812	S	12/1992	Bunger

6,088,983	A *	7/2000	Applebee	52/282.1
6,564,523	B1	5/2003	Iole et al.		
D478,179	S	8/2003	Fifield		
D595,431	S *	6/2009	Day	D25/140
7,845,141	B2	12/2010	Martinique		
2006/0059836	A1 *	3/2006	Monsieur	52/588.1
2009/0223550	A1	9/2009	Curtin et al.		

* cited by examiner

Primary Examiner — Doris Clark

(74) *Attorney, Agent, or Firm* — Baker & McKenzie LLP

(57) **CLAIM**

The ornamental design for a shingle roof panel, as shown and described.

DESCRIPTION

FIG. 1 is a perspective view of a shingle roof panel in accordance with our design;

FIG. 2 is another perspective view of the shingle roof panel in accordance with the embodiment of our design;

FIG. 3 is a top plan view of the shingle roof panel in accordance with the embodiment of our design;

FIG. 4 is a front elevation view of the shingle roof panel in accordance with the embodiment of our design;

FIG. 5 is a left side elevation view of the shingle roof panel in accordance with the embodiment of our design, the opposite side being a mirror image;

FIG. 6 is a right side elevation view of the shingle roof panel in accordance with the embodiment of our design, the opposite side being a mirror image;

FIG. 7 is a back elevation view of the shingle roof panel in accordance with the embodiment of our design; and,

FIG. 8 is a bottom plan view of the shingle roof panel in accordance with the embodiment of our design.

The broken lines showing environmental structure are for illustrative purposes and form no part of the claimed design.

1 Claim, 4 Drawing Sheets

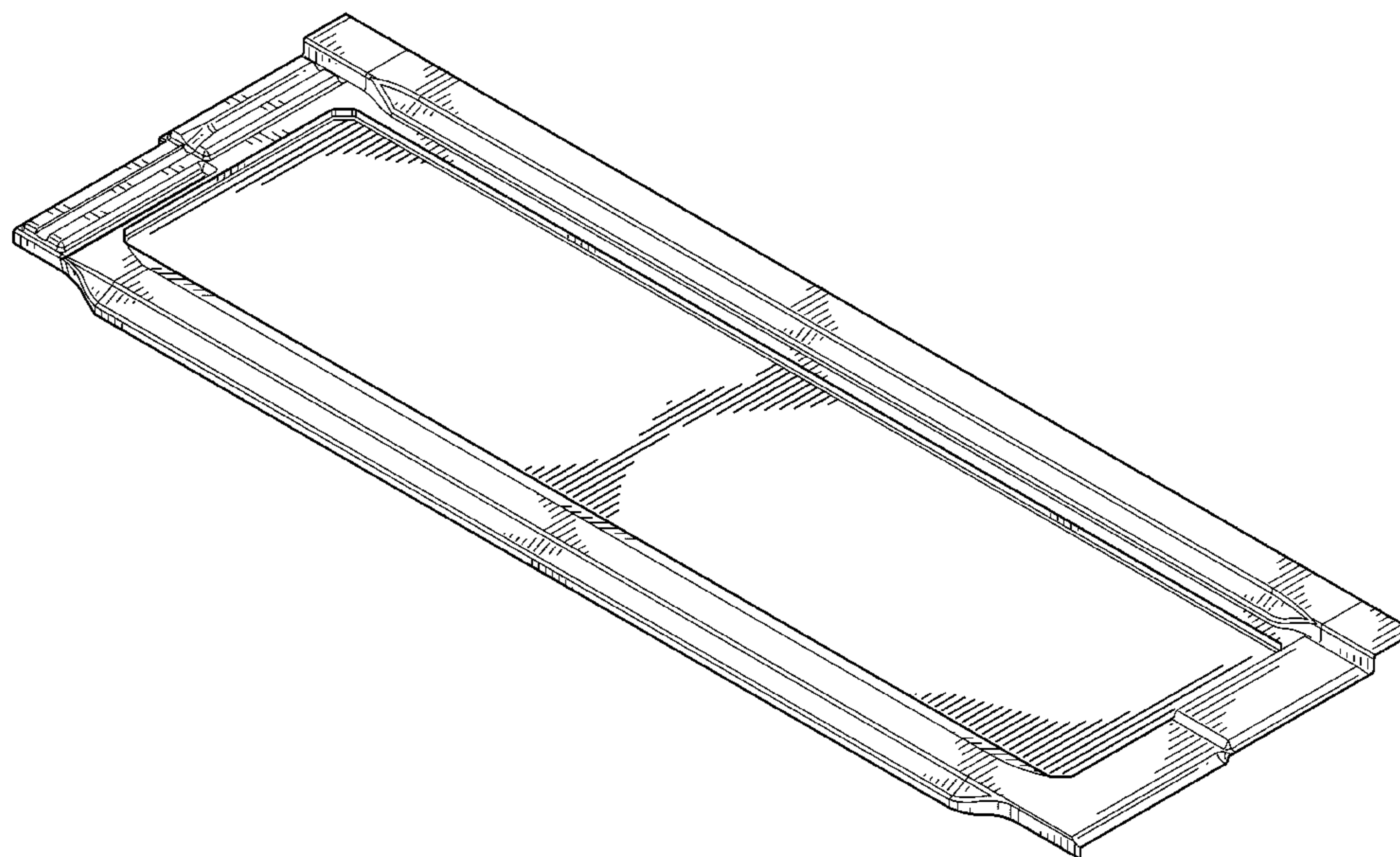

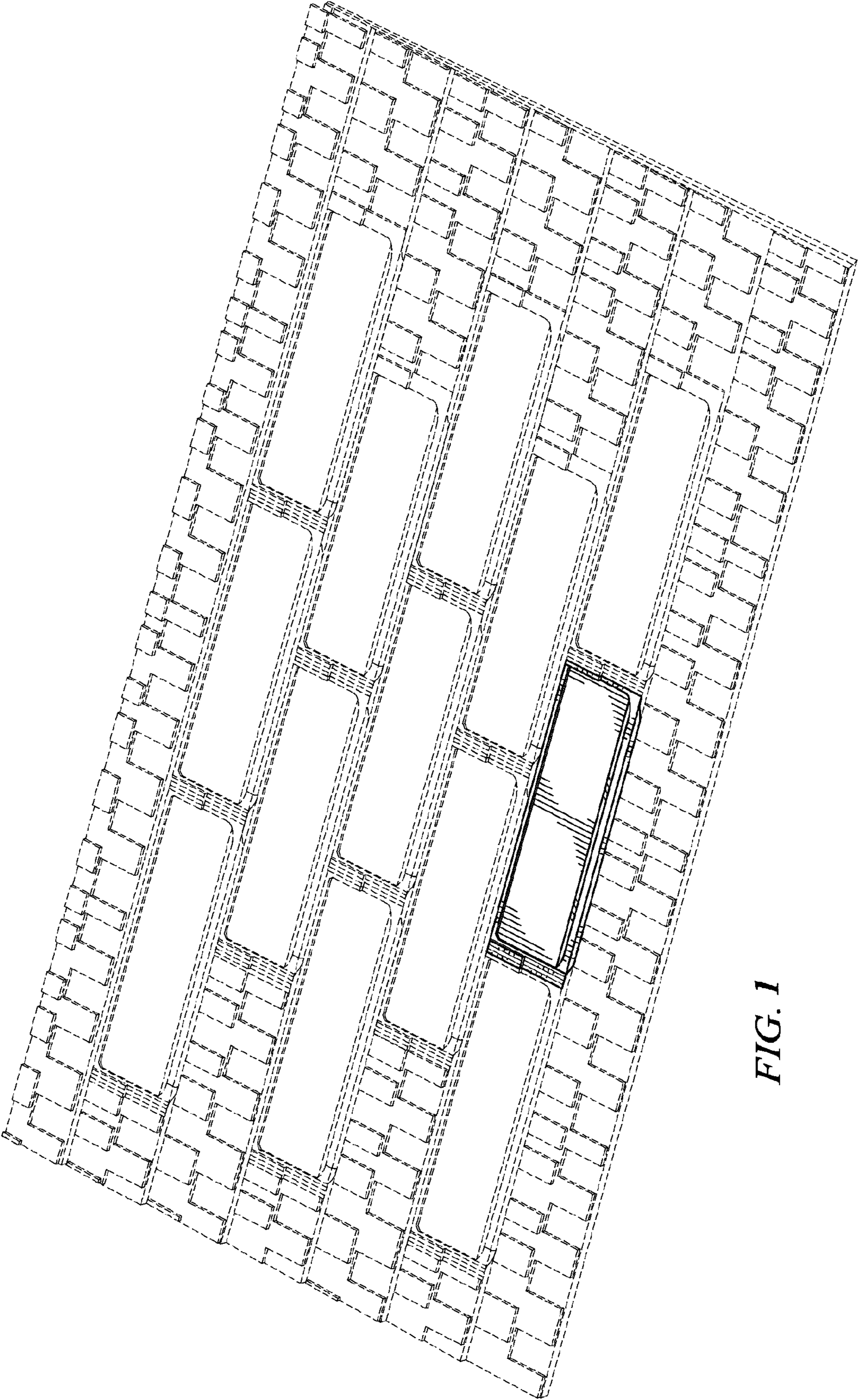

FIG. 1

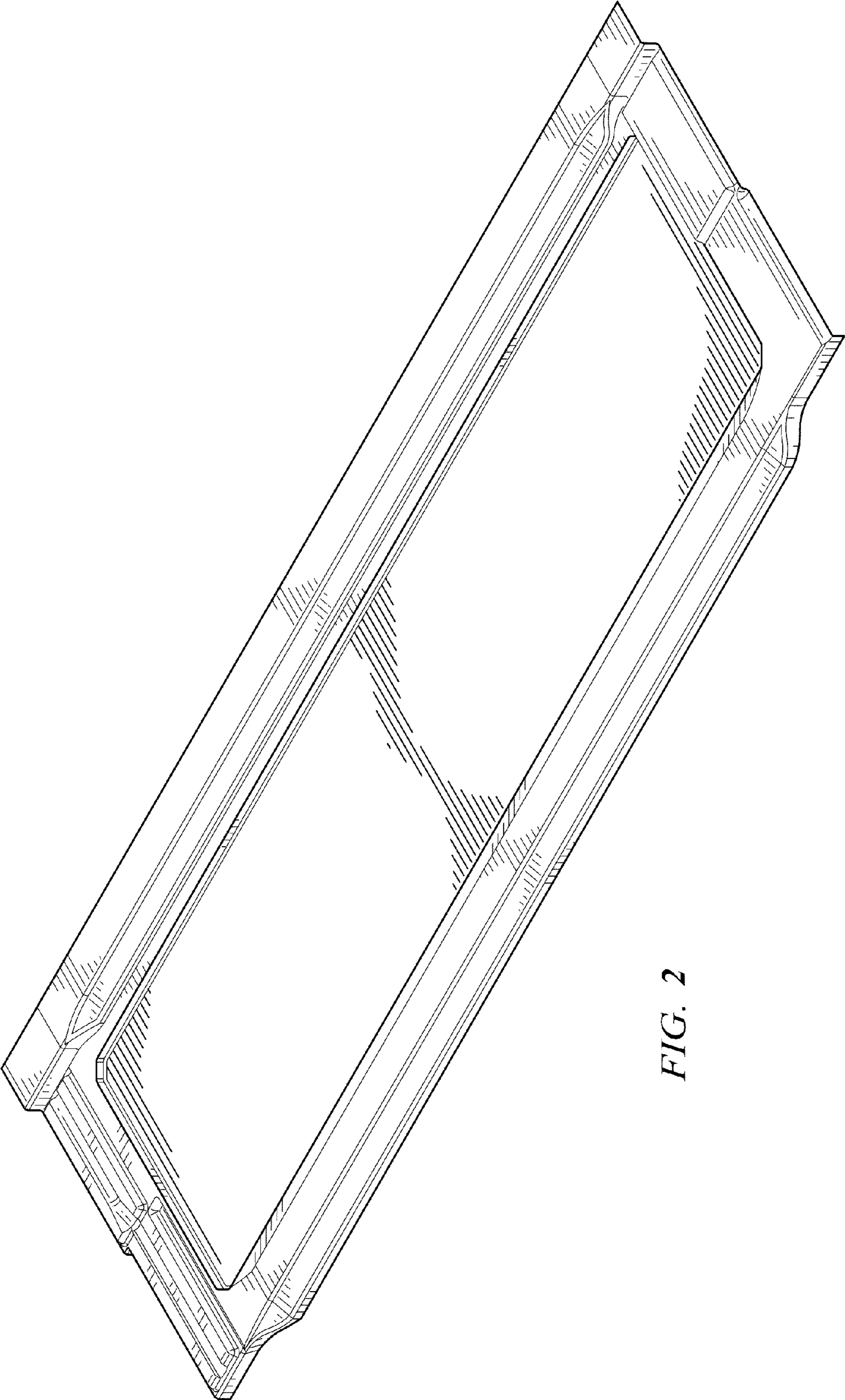

FIG. 2

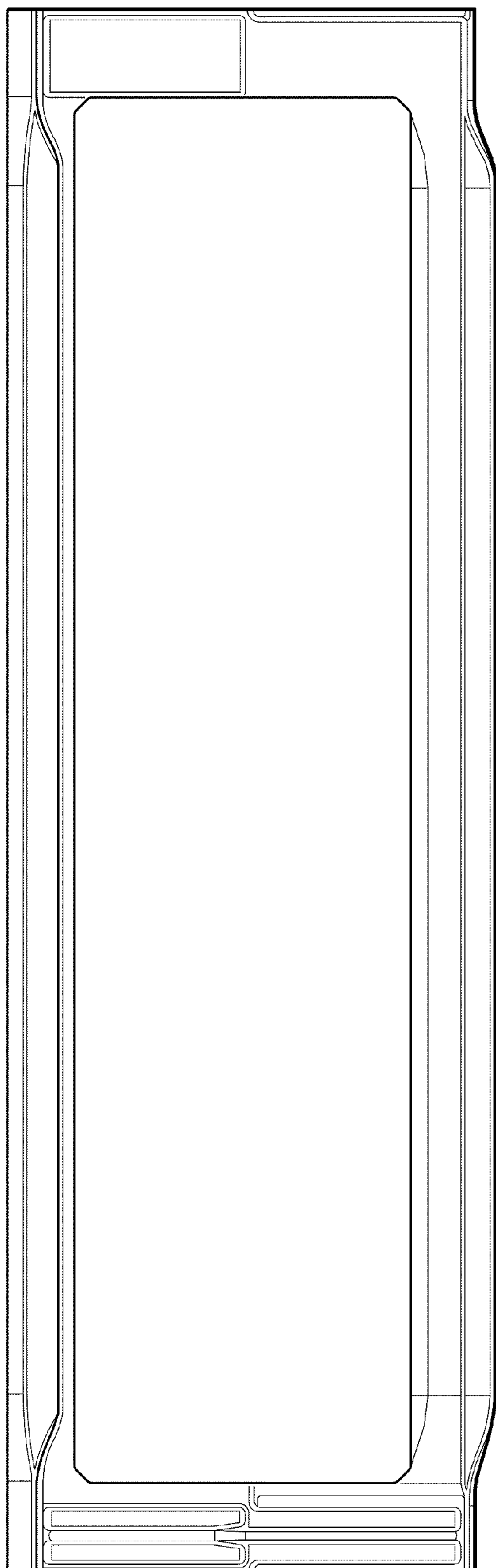

FIG. 3



FIG. 4

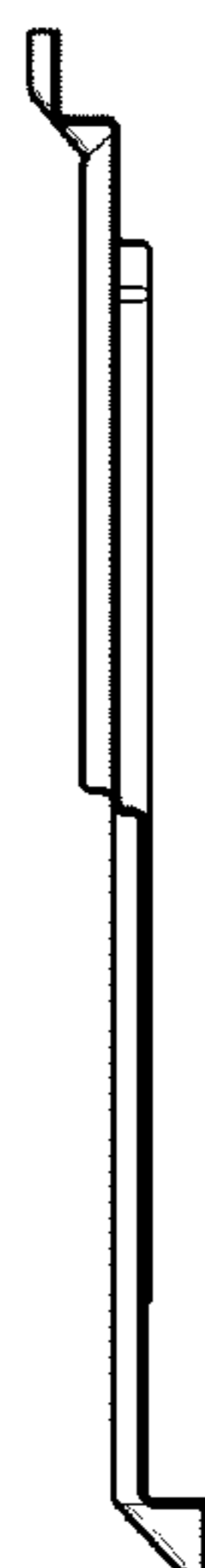

FIG. 5

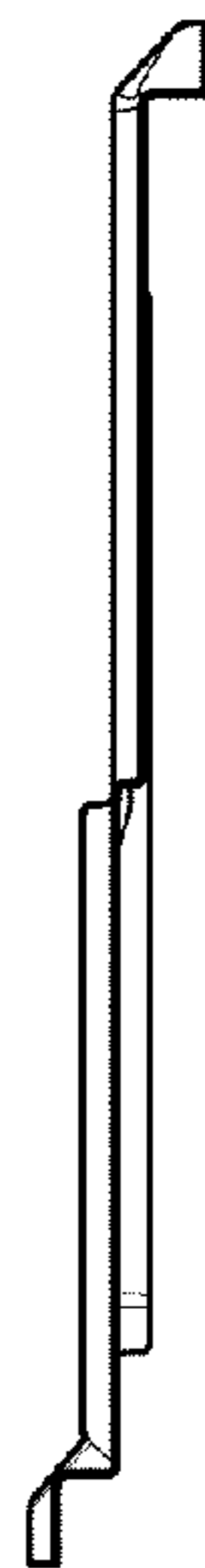

FIG. 6

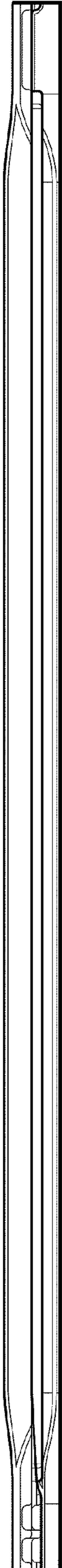

FIG. 7

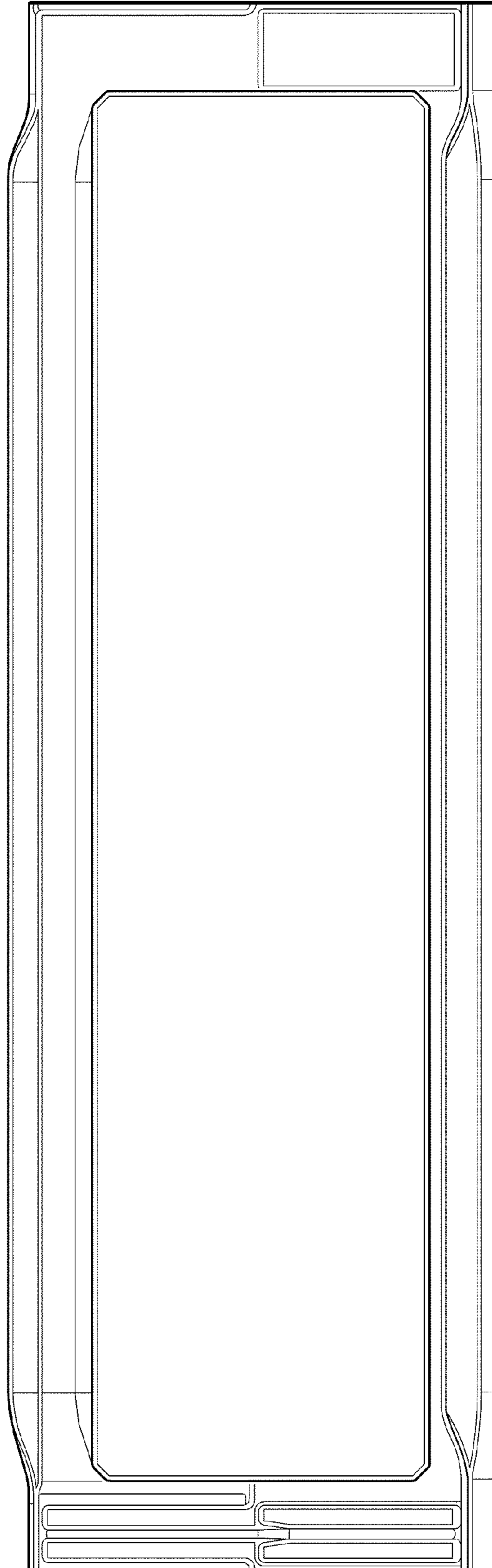

FIG. 8