



US00D650905S

(12) **United States Design Patent**
Plascott et al.

(10) **Patent No.:** **US D650,905 S**

(45) **Date of Patent:** **** Dec. 20, 2011**

(54) **MASK SIZING/FITTING TOOL**

Primary Examiner — Bridget L Eland

(74) *Attorney, Agent, or Firm* — Nixon & Vanderhye P.C.

(75) Inventors: **Stuart Norris Plascott**, Macquarie Park (AU); **Shiva Kumar Shanmuga Sundara**, Bella Vista (AU); **Jamie Graeme Wehbeh**, Mosman (AU)

(57) **CLAIM**

The ornamental design for a mask sizing/fitting tool, as shown and described.

(73) Assignee: **ResMed Limited**, Bella Vista (AU)

(**) Term: **14 Years**

DESCRIPTION

(21) Appl. No.: **29/371,013**

(22) Filed: **Sep. 13, 2010**

(51) **LOC (9) Cl.** **24-02**

(52) **U.S. Cl.** **D24/140**

(58) **Field of Classification Search** D24/110,
D24/110.1, 140; 128/863

See application file for complete search history.

(56) **References Cited**

U.S. PATENT DOCUMENTS

D314,434 S *	2/1991	Kamen	D24/127
D324,897 S *	3/1992	Colucci	D21/791
D351,769 S *	10/1994	Brass et al.	D3/315
D356,377 S *	3/1995	Tsubota et al.	D24/165
D430,674 S *	9/2000	Dunshee et al.	D24/189
D499,182 S *	11/2004	Moore et al.	D24/146
D502,995 S *	3/2005	Cook et al.	D24/152
D559,388 S *	1/2008	Melcher	D24/150
D561,896 S *	2/2008	Jones	D24/130
D594,130 S *	6/2009	Scocimara et al.	D24/209
2004/0250818 A1 *	12/2004	Cook et al.	128/861

FOREIGN PATENT DOCUMENTS

EM 001614173-0001 * 9/2009

* cited by examiner

FIG. 1 is a front perspective view of a mask sizing/fitting tool according to a first embodiment of our new ornamental design;

FIG. 2 is a rear perspective view thereof;

FIG. 3 is a front view thereof;

FIG. 4 is a rear view thereof;

FIG. 5 is a top view thereof;

FIG. 6 is a bottom view thereof;

FIG. 7 is a left side view thereof;

FIG. 8 is a right side view thereof;

FIG. 9 is a front perspective view of a mask sizing/fitting tool according to a second embodiment of our new ornamental design;

FIG. 10 is a front view thereof;

FIG. 11 is a rear view thereof;

FIG. 12 is a top view thereof;

FIG. 13 is a bottom view thereof;

FIG. 14 is a left side view thereof;

FIG. 15 is a right side view thereof; and,

FIG. 16 is a rear perspective view thereof, in which the slider has been moved to the “medium” size position.

Where included, broken lines represent environmental structure and do not form a part of the claimed design.

1 Claim, 12 Drawing Sheets

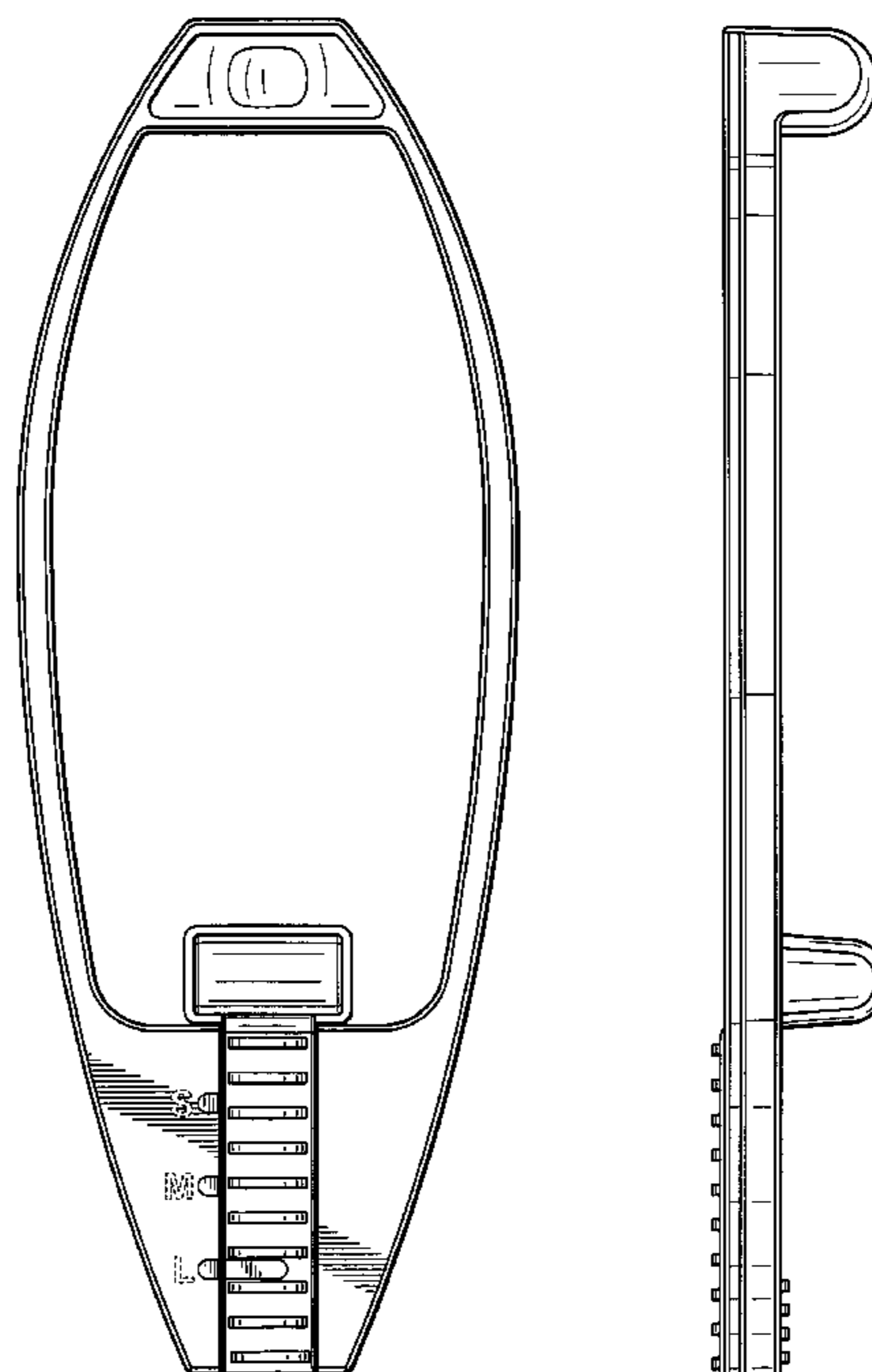

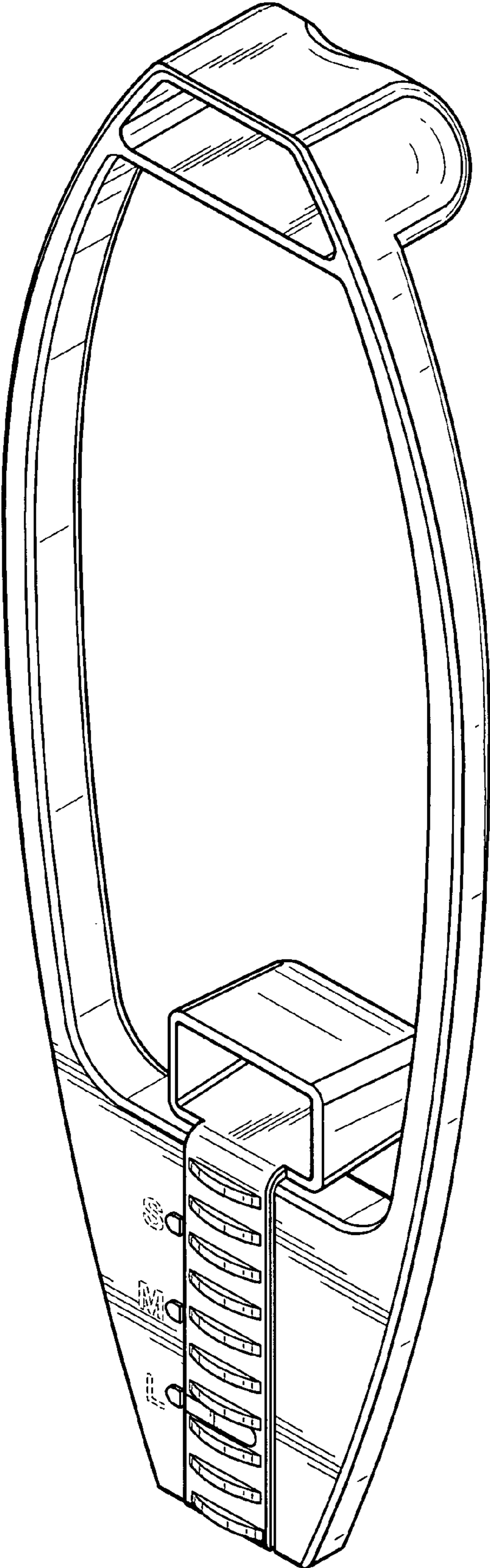

FIG. 1

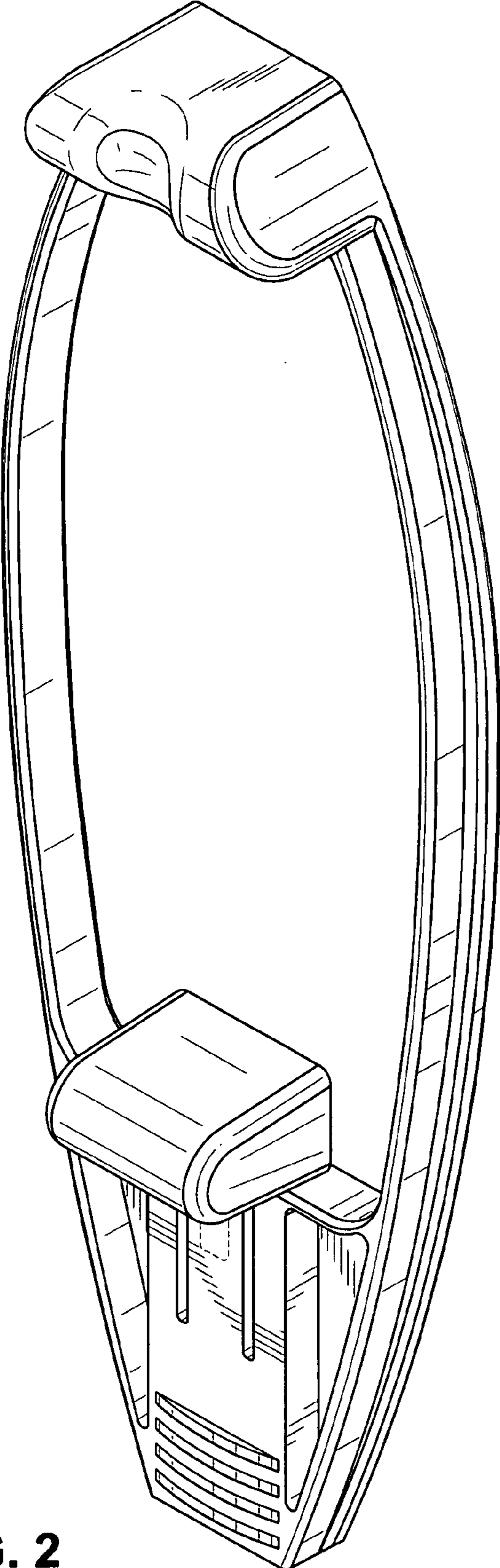

FIG. 2

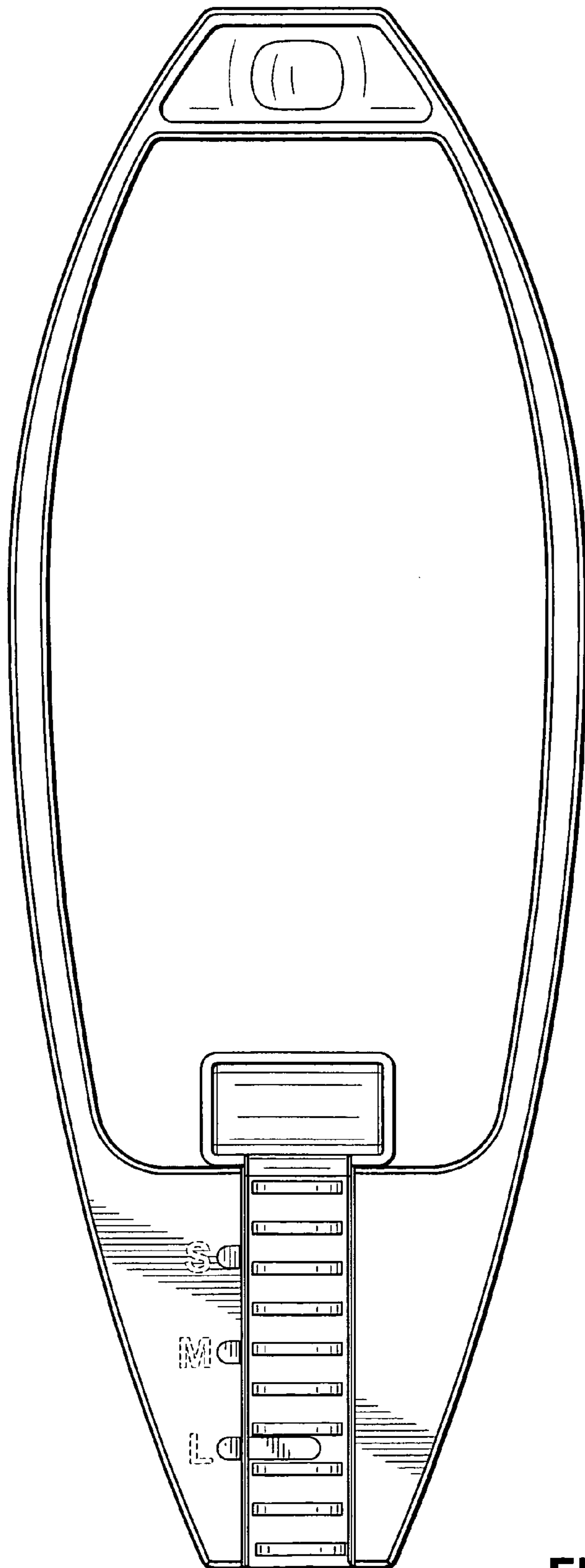

FIG. 3

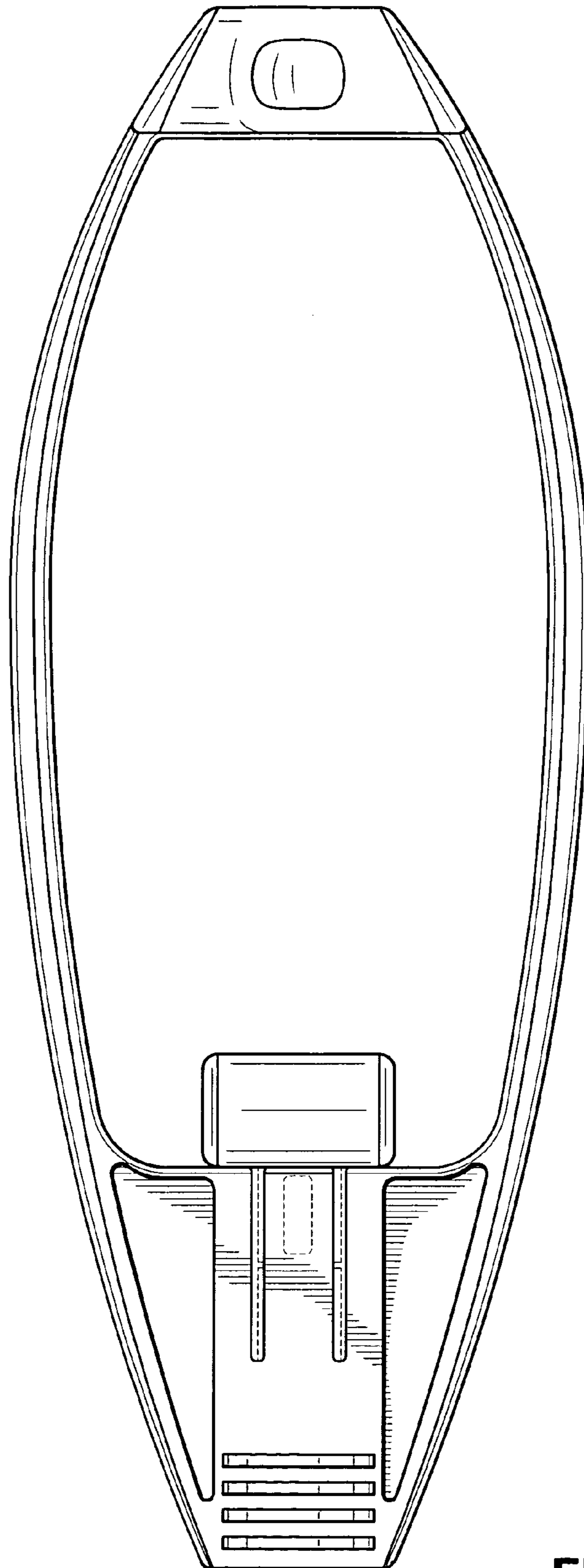

FIG. 4

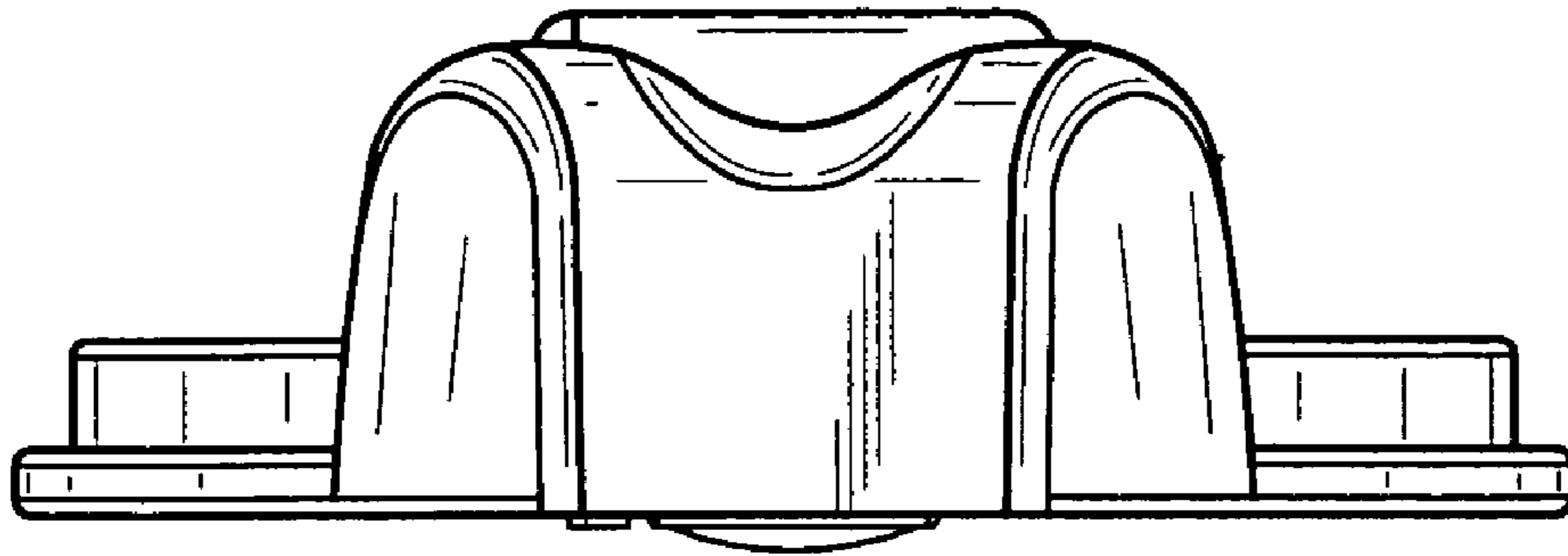

FIG. 5

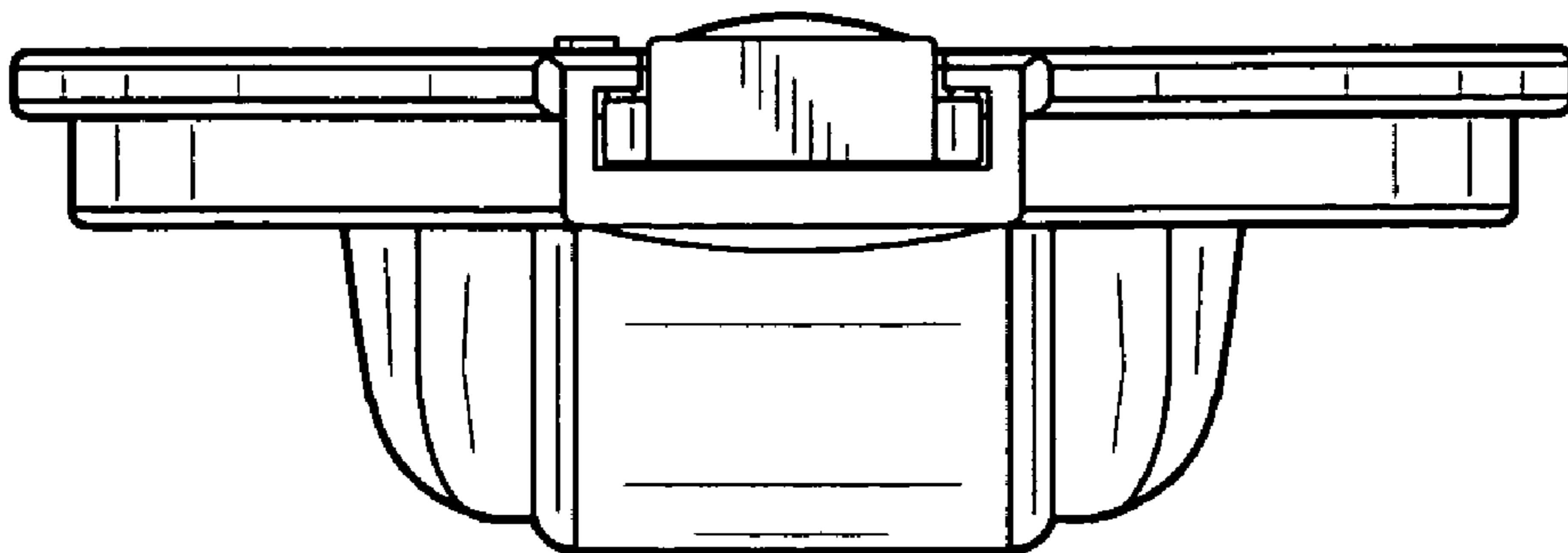

FIG. 6

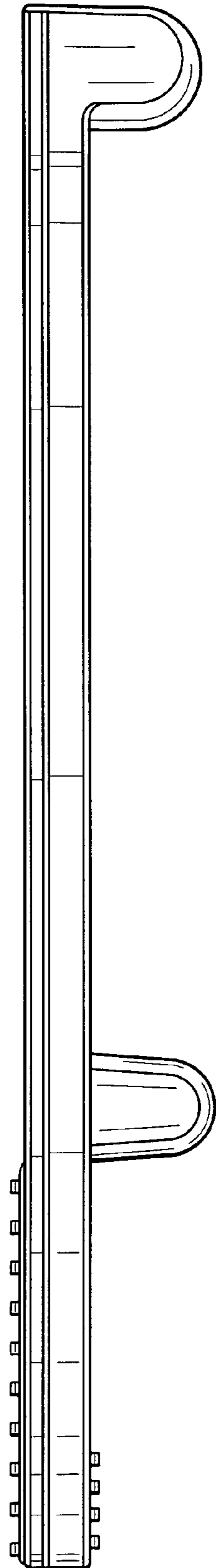

FIG. 7

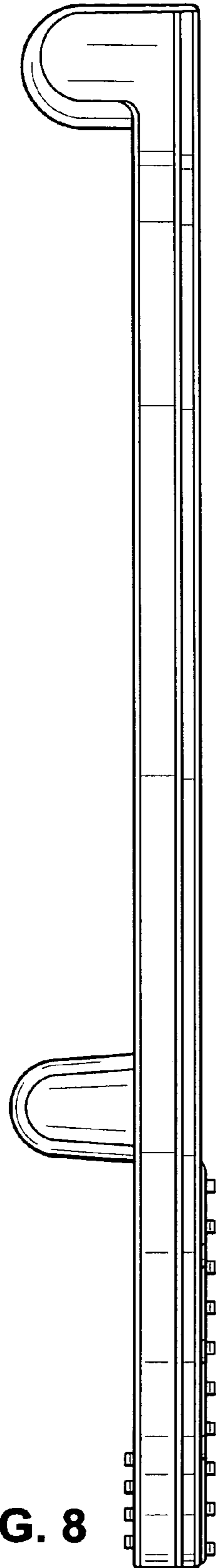

FIG. 8

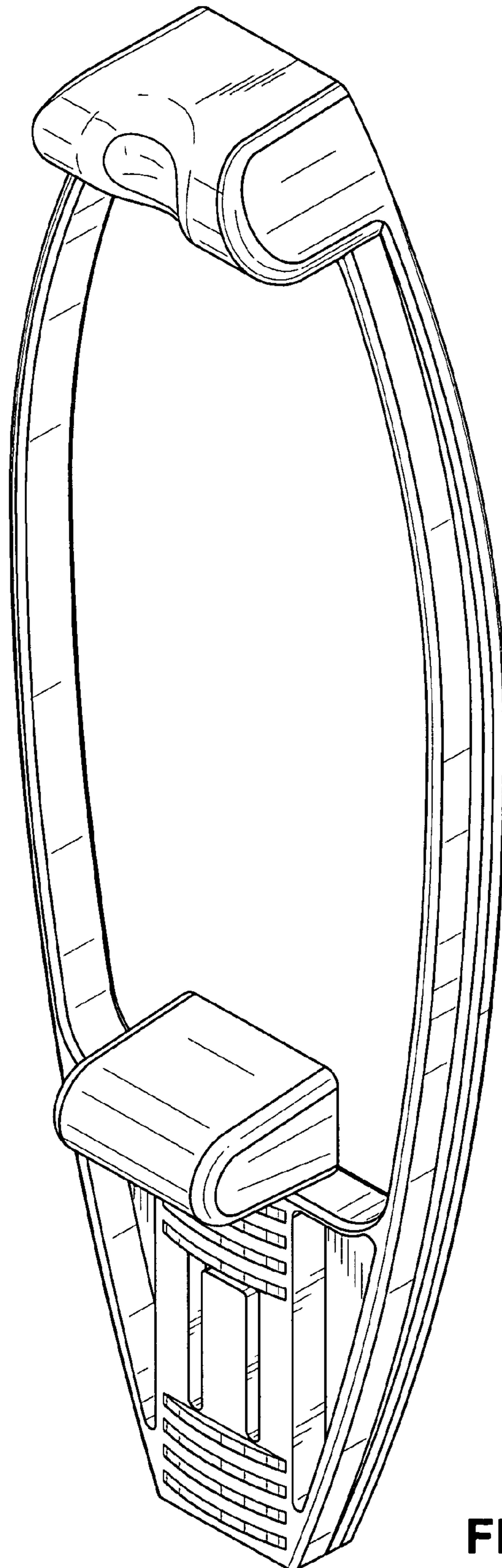

FIG. 9

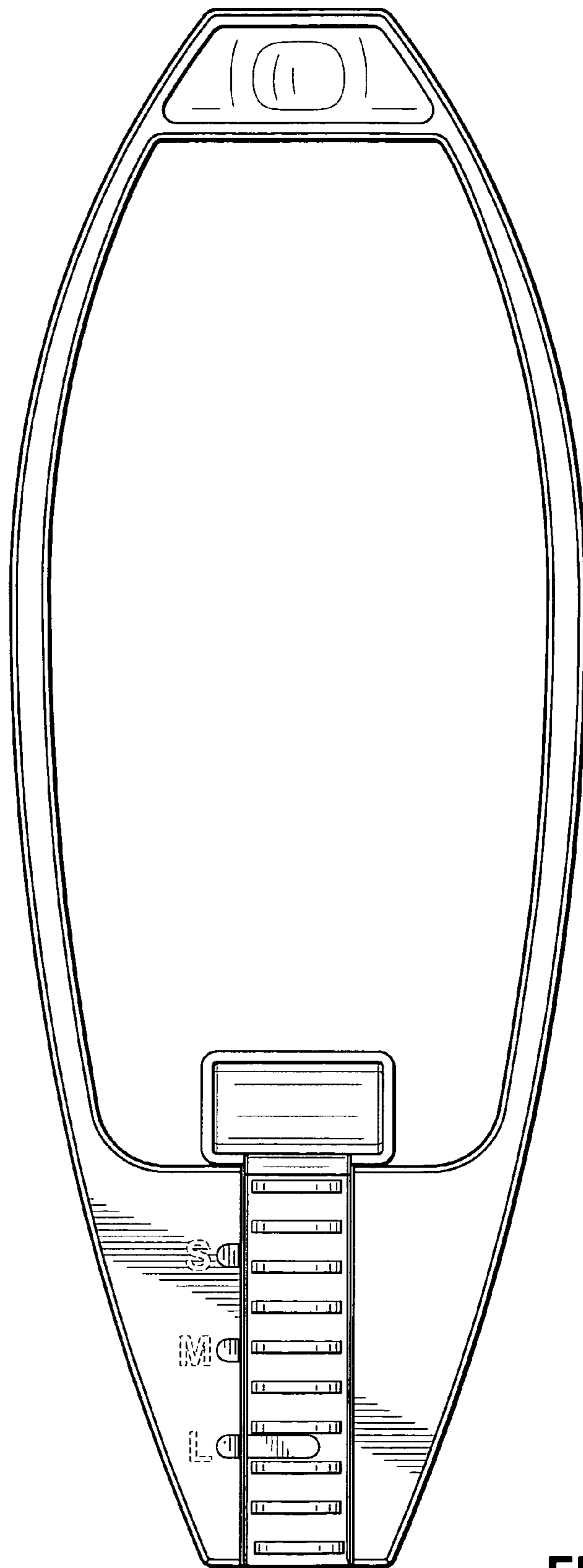

FIG. 10

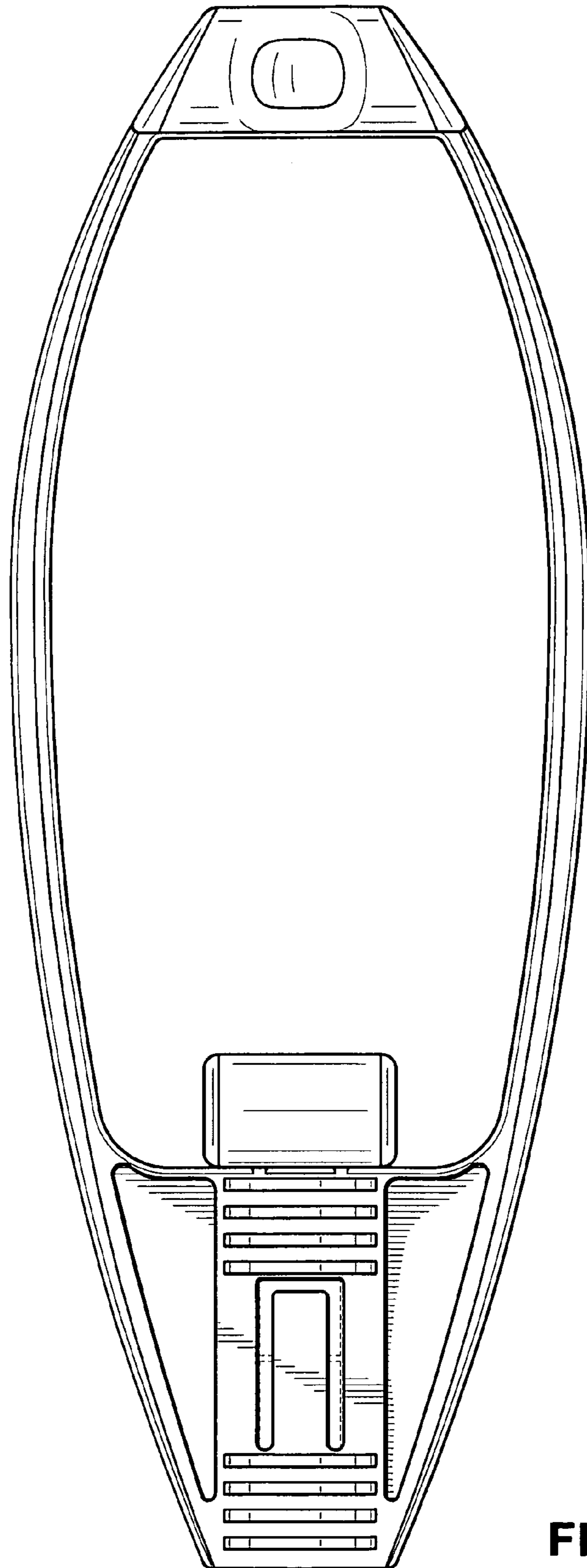

FIG. 11

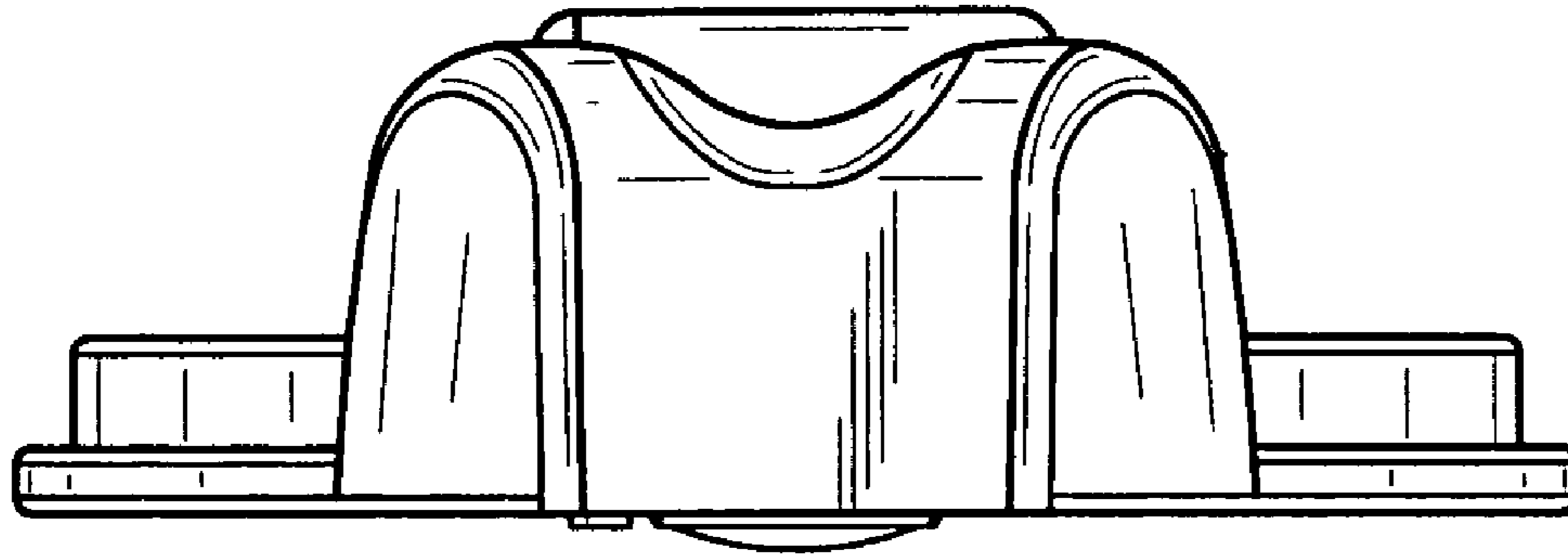

FIG. 12

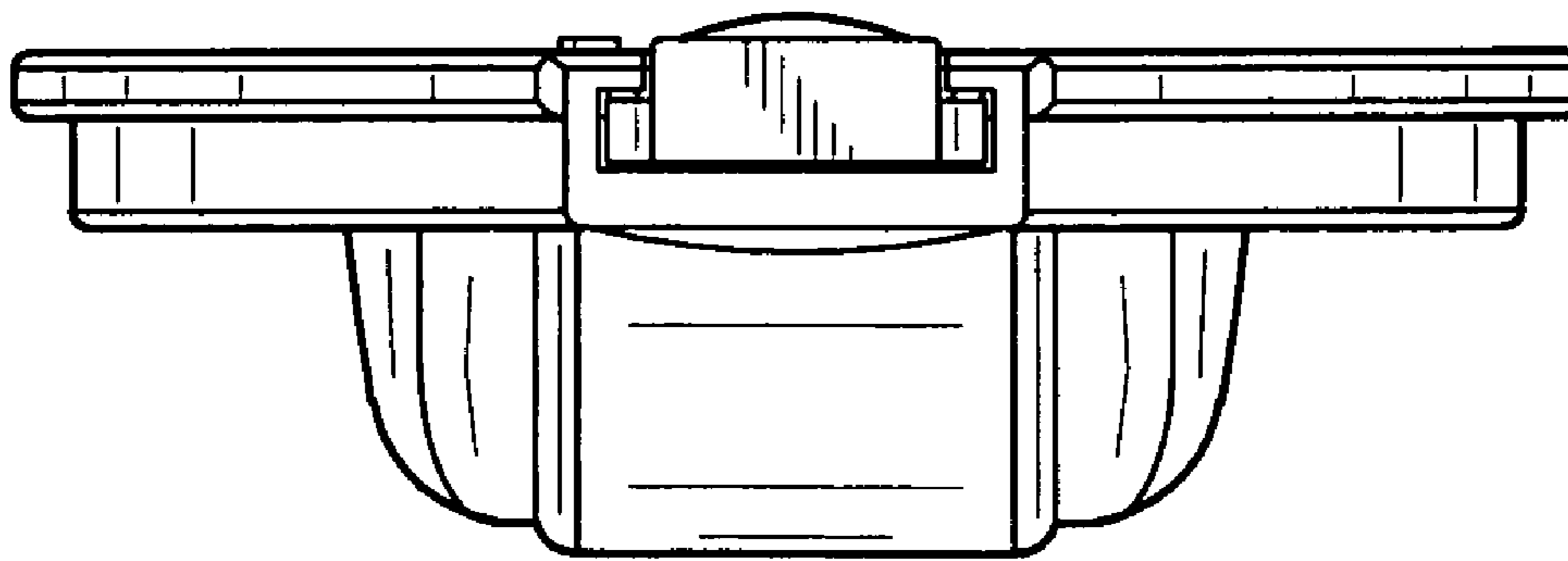

FIG. 13

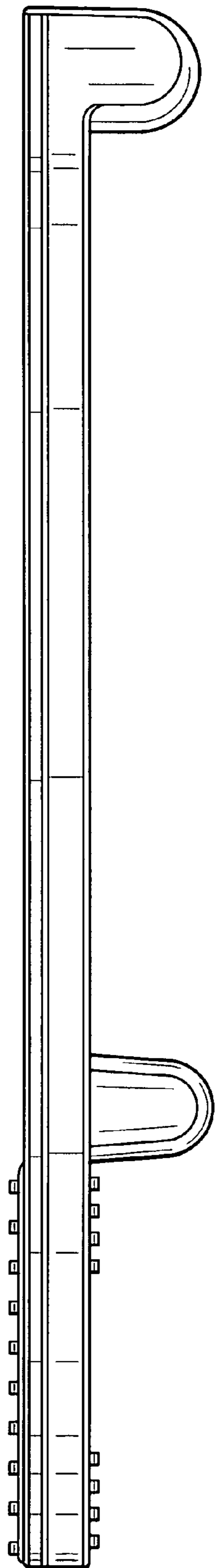

FIG. 14

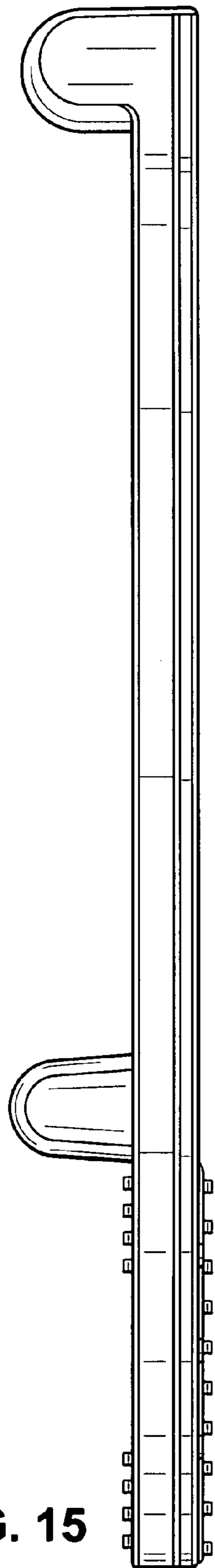

FIG. 15

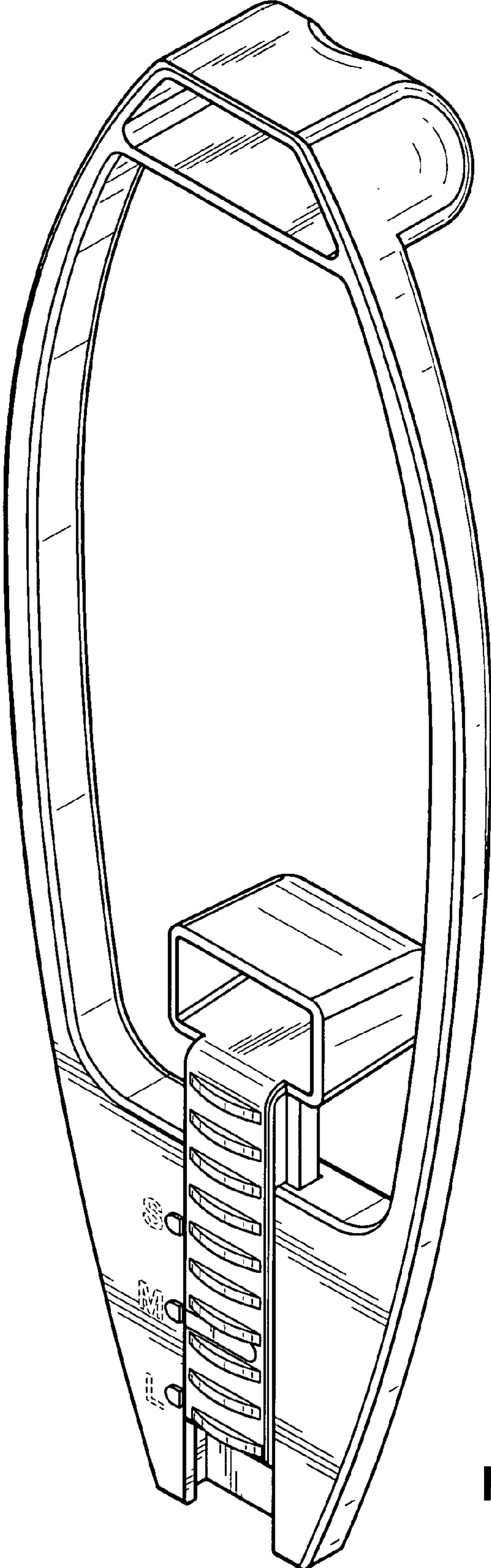

FIG. 16