



US00D650841S

(12) **United States Design Patent**
Jones et al.

(10) **Patent No.:** **US D650,841 S**

(45) **Date of Patent:** **** *Dec. 20, 2011**

(54) **INK STICK FOR A PHASE CHANGE INK JET PRINTER**

(75) Inventors: **Brent Rodney Jones**, Sherwood, OR (US); **Jonathan R Ritter**, Cupertino, CA (US); **Brian Walter Aznoe**, Sherwood, OR (US); **Christopher R Gold**, Tigard, OR (US)

(73) Assignee: **Xerox Corporation**, Norwalk, CT (US)

(*) Notice: This patent is subject to a terminal disclaimer.

(**) Term: **14 Years**

(21) Appl. No.: **29/375,689**

(22) Filed: **Sep. 27, 2010**

(51) **LOC (9) Cl.** **18-02**

(52) **U.S. Cl.** **D18/56**

(58) **Field of Classification Search** D18/56;
347/88, 99; 106/31.29, 31.61

See application file for complete search history.

(56) **References Cited**

U.S. PATENT DOCUMENTS

D371,802 S * 7/1996 Jones et al. D18/56
D372,268 S * 7/1996 Jones et al. D18/56

D409,237 S * 5/1999 Ellers et al. D18/56
D410,026 S * 5/1999 Brown et al. D18/56
D412,527 S * 8/1999 Ellers et al. D18/56
D412,934 S * 8/1999 Jones D18/56
D414,200 S * 9/1999 Jones D18/56
D440,249 S * 4/2001 Ellers et al. D18/56
D482,389 S * 11/2003 Jones D18/56
D506,779 S * 6/2005 Jones et al. D18/56
D520,559 S * 5/2006 Jones D18/56
D535,329 S * 1/2007 Jones et al. D18/56
D537,874 S * 3/2007 Korn et al. D18/56

* cited by examiner

Primary Examiner — David Muller

(74) *Attorney, Agent, or Firm* — Tallam I. Nguti

(57) **CLAIM**

The ornamental design for an ink stick for a phase change ink jet printer, as shown and described.

DESCRIPTION

FIG. 1 is a perspective view of an ink stick for a phase change ink jet printer in accordance with the present invention; FIG. 2 is a front elevation view thereof; FIG. 3 is a right side elevation view thereof; FIG. 4 is a rear elevation view thereof; FIG. 5 is a left side elevation view thereof; FIG. 6 is a top plan view thereof; and, FIG. 7 is a bottom plan view thereof.

The features shown in broken lines in the drawing figures depict environmental subject matter only and form no part of the claimed design.

1 Claim, 7 Drawing Sheets

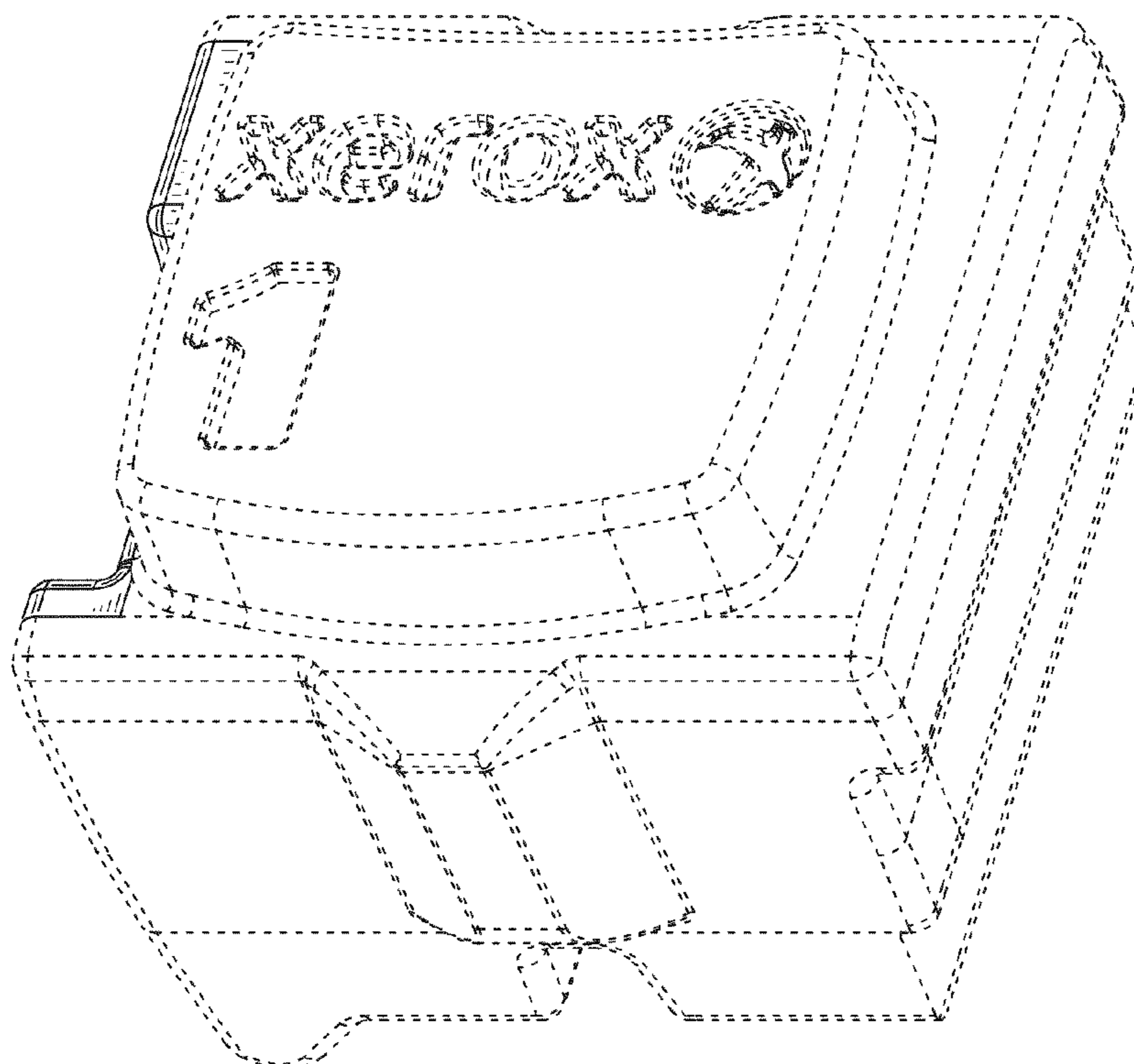

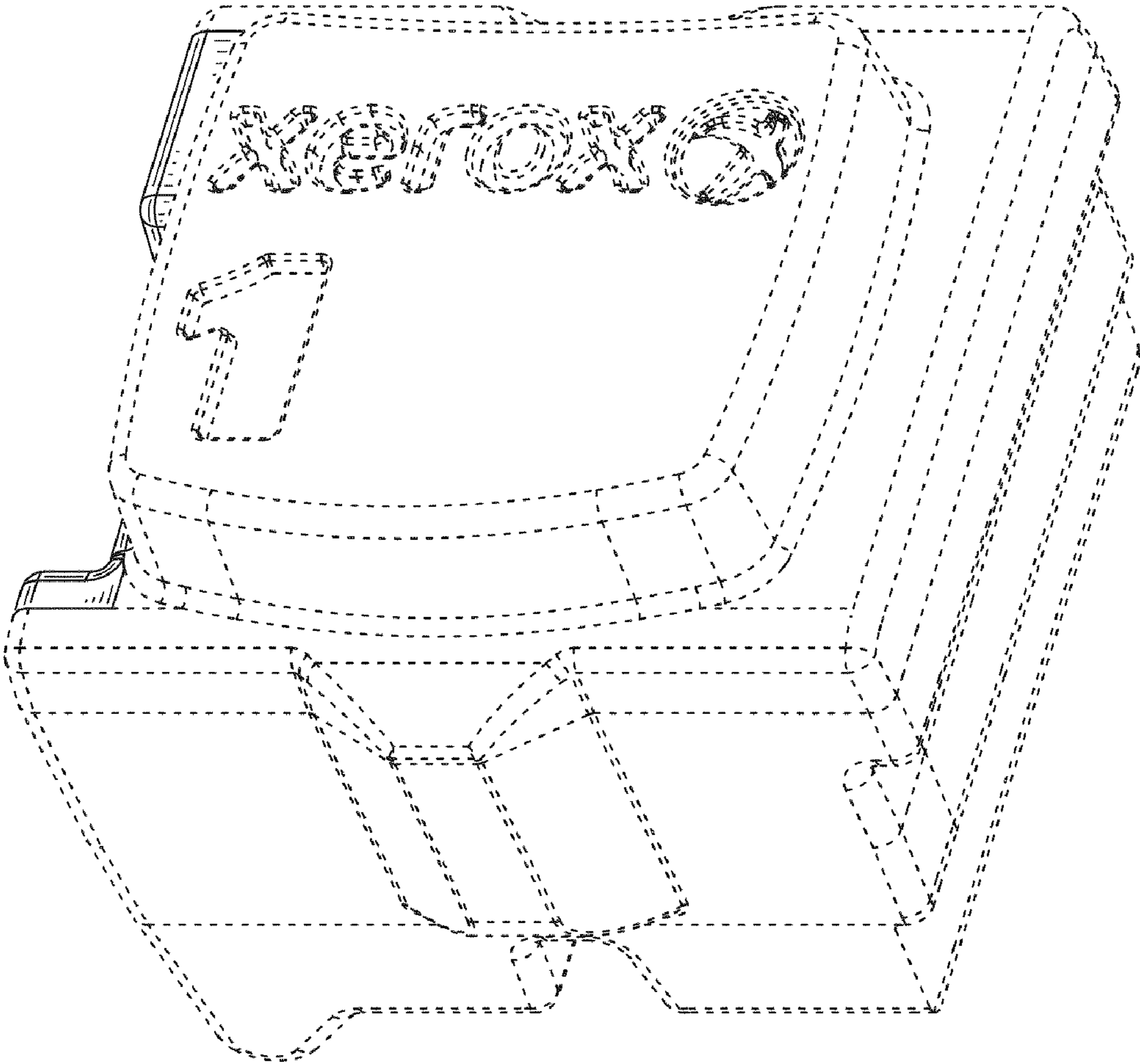

FIG. 1

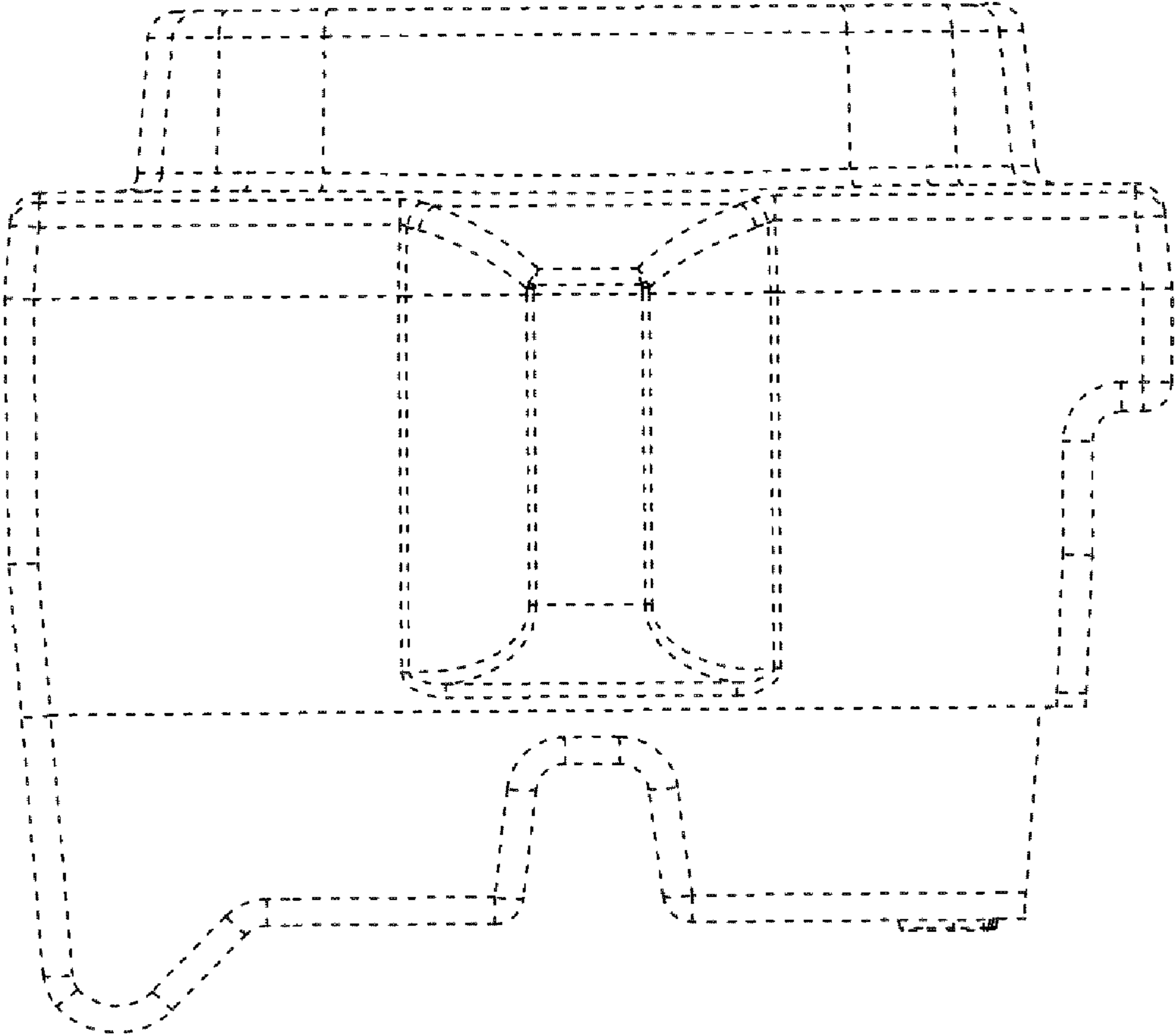

FIG. 2

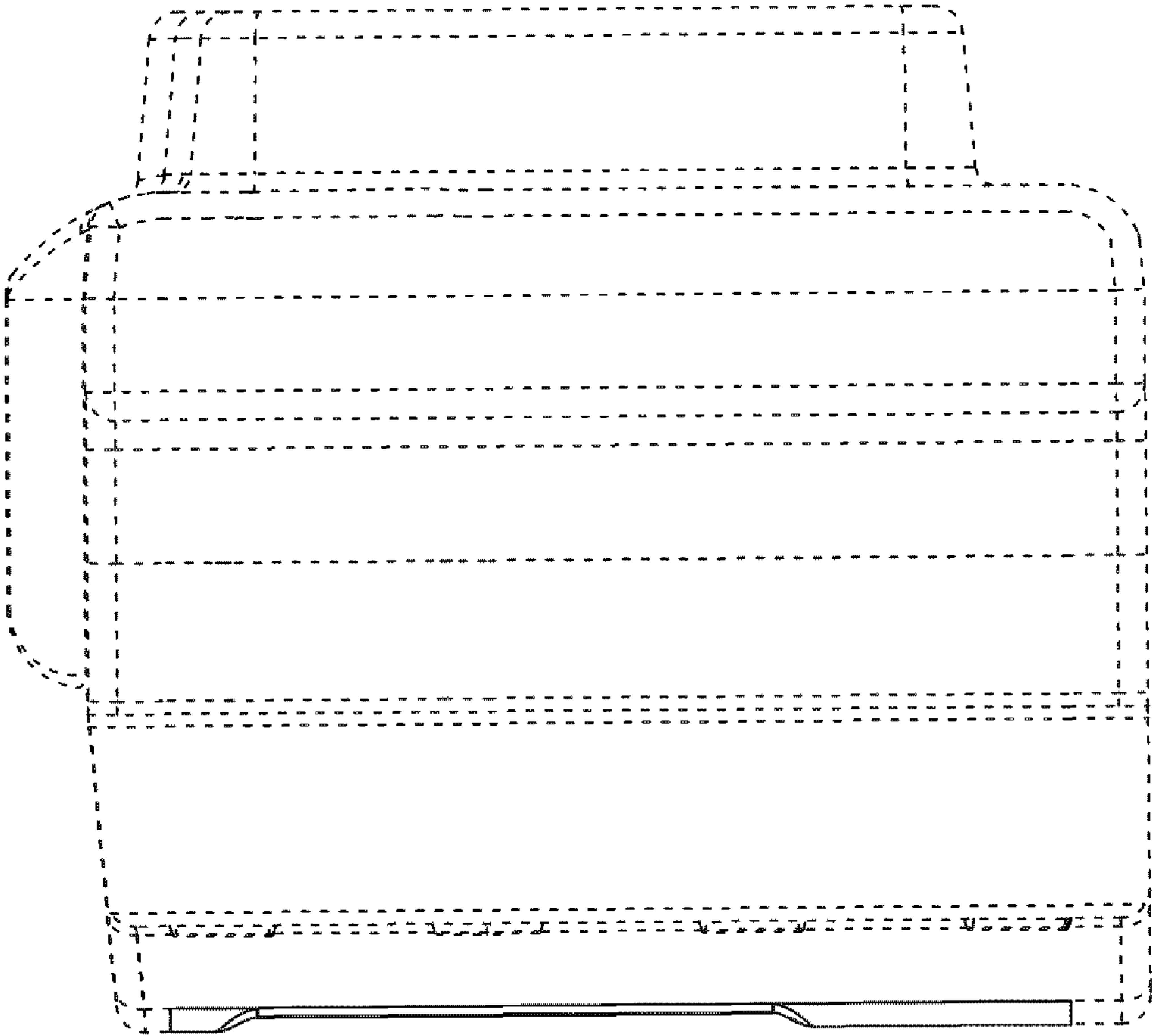

FIG. 3

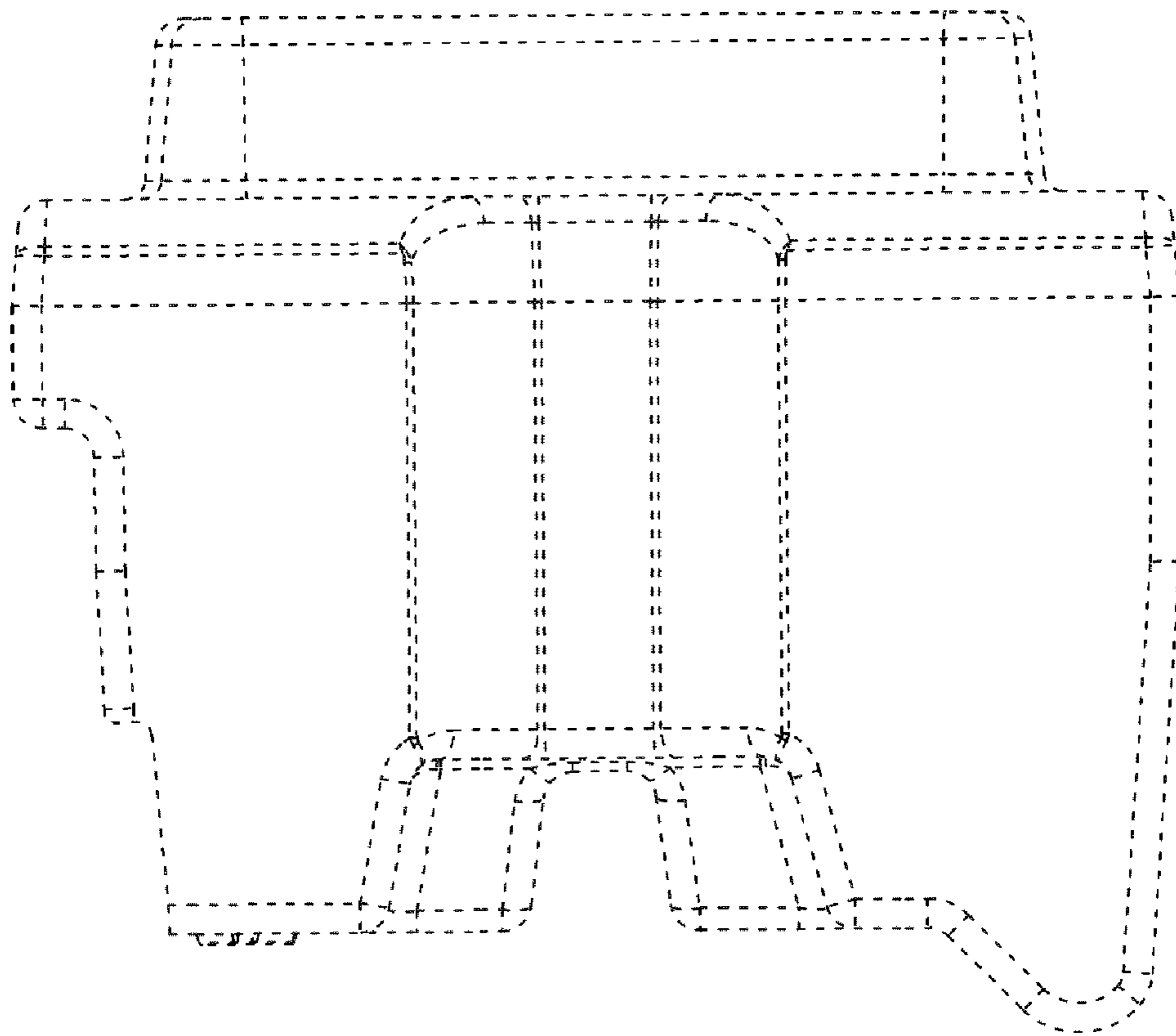

FIG. 4

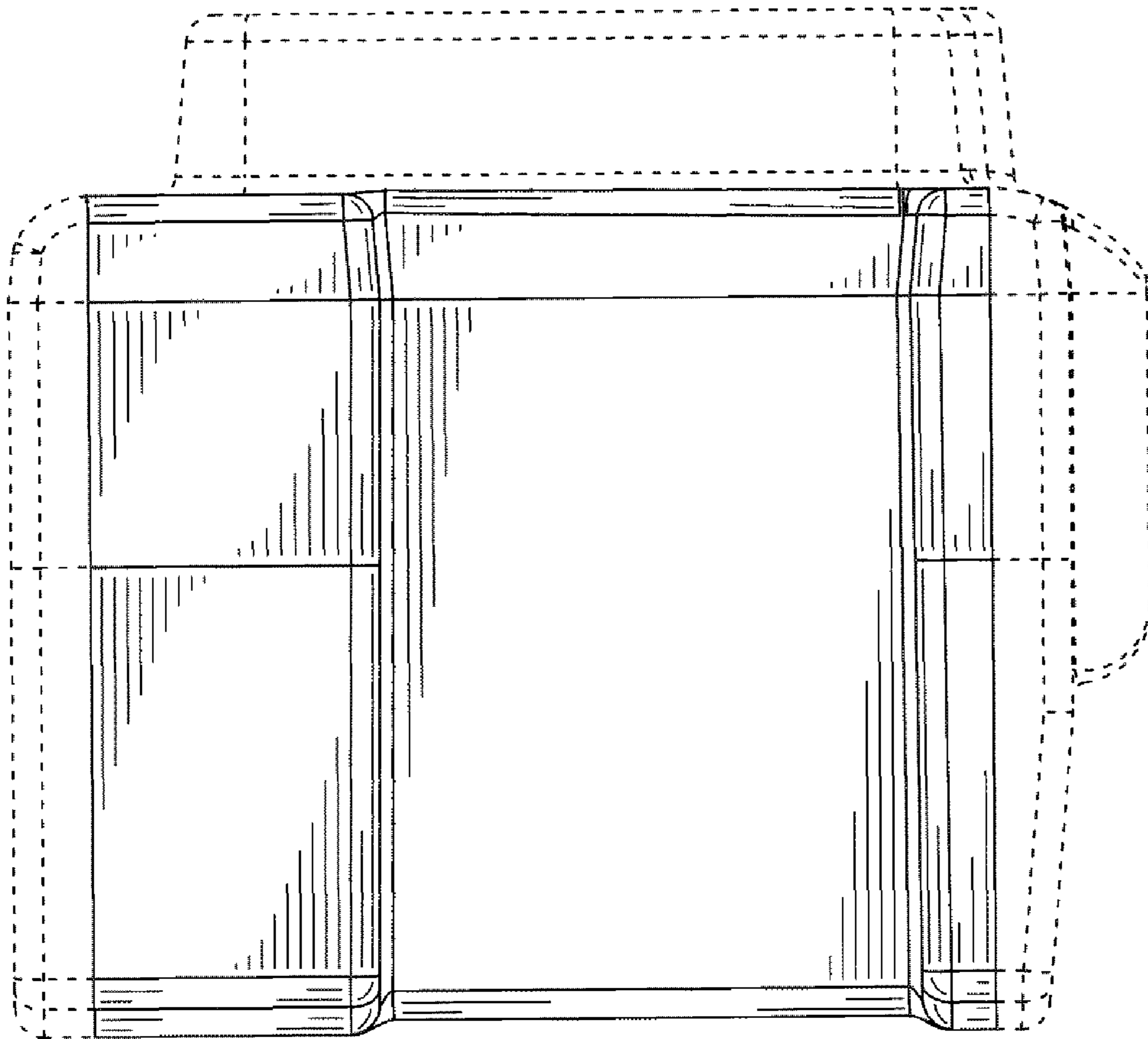

FIG. 5

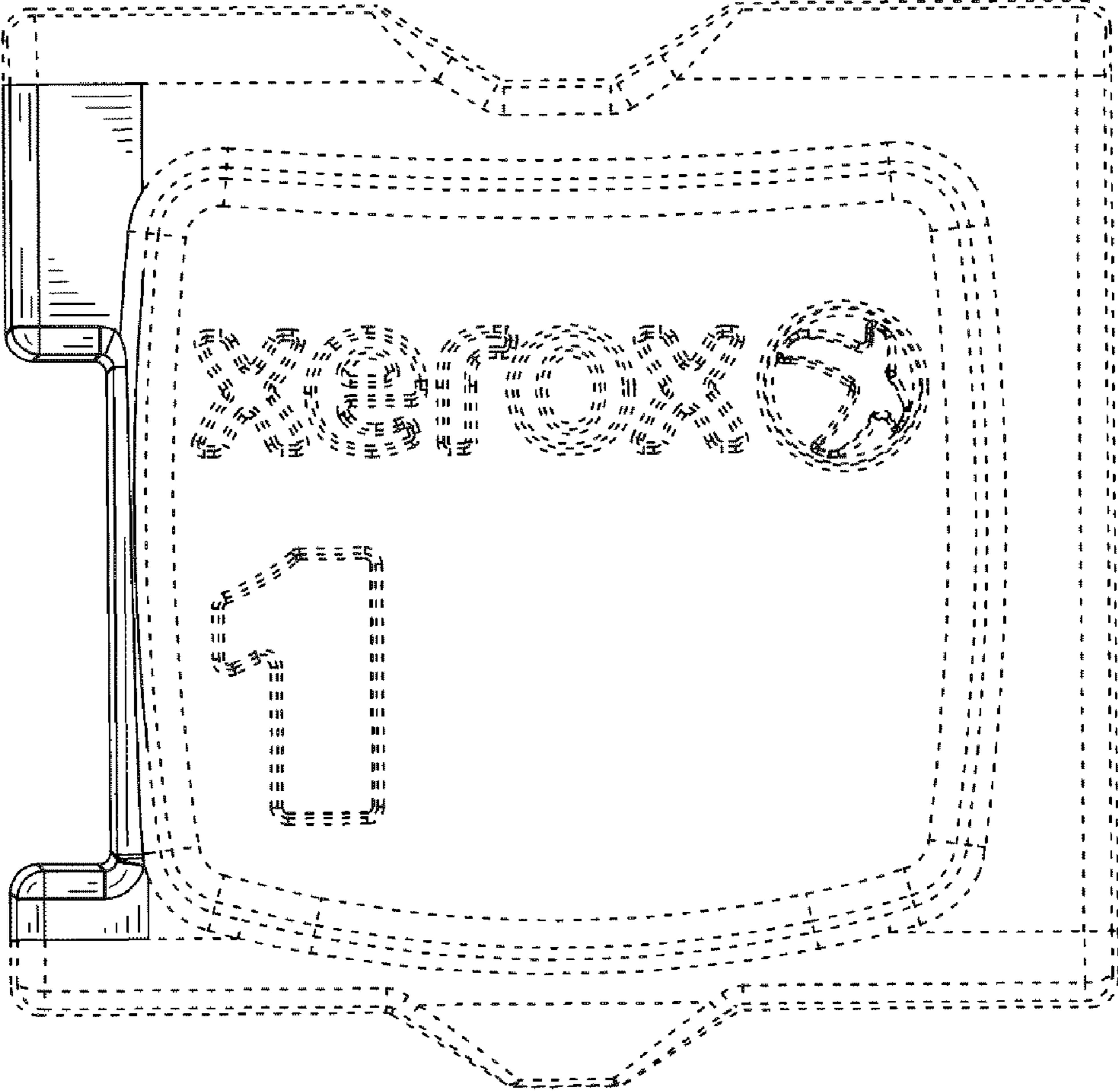

FIG. 6

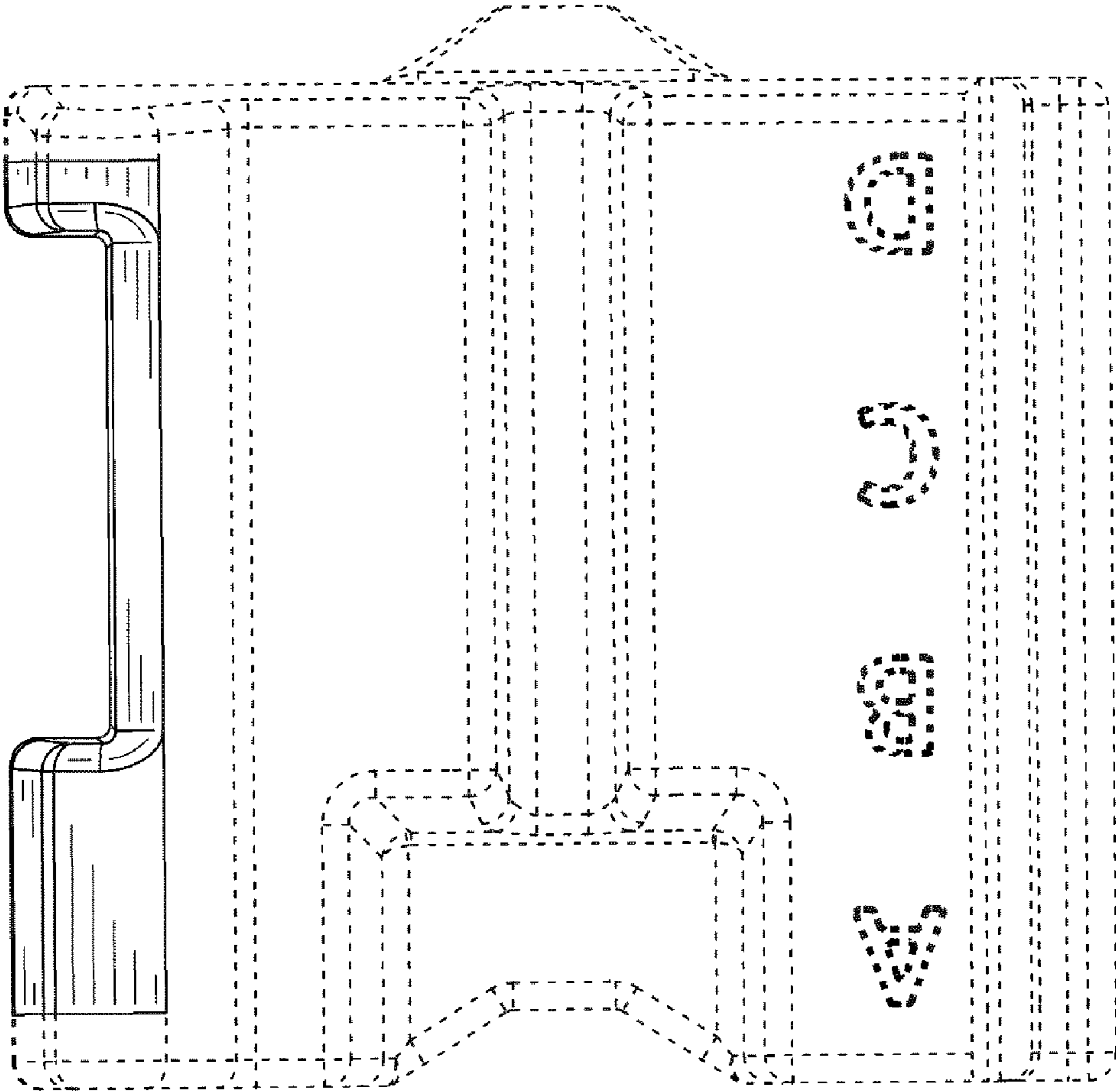

FIG. 7