



US00D650754S

(12) **United States Design Patent**
Bodmann et al.

(10) **Patent No.:** **US D650,754 S**

(45) **Date of Patent:** **** Dec. 20, 2011**

(54) **MALE COMMUNICATION CONNECTOR OF AN AUTOMATION DEVICE**

(75) Inventors: **Douglas R. Bodmann**, Shaker Heights, OH (US); **Chee Lim Wong**, Singapore (SG)

(73) Assignee: **Rockwell Automation Technologies, Inc.**, Mayfield Heights, OH (US)

(**) Term: **14 Years**

(21) Appl. No.: **29/385,605**

(22) Filed: **Feb. 16, 2011**

(51) **LOC (9) Cl.** **13-03**

(52) **U.S. Cl.** **D13/147**

(58) **Field of Classification Search** D13/146, D13/147, 154, 184, 199; 439/62, 79, 260, 439/329, 395, 422, 499, 607.01, 607.04, 439/607.05, 607.17, 607.25, 607.34, 607.41, 439/607.53, 540.1, 541.5, 660, 680, 686

See application file for complete search history.

(56) **References Cited**

U.S. PATENT DOCUMENTS

D601,505 S * 10/2009 Fukazawa et al. D13/147
D601,506 S * 10/2009 Fukazawa et al. D13/147

D602,870 S * 10/2009 Wu et al. D13/147
D616,828 S * 6/2010 Tung et al. D13/147
D617,281 S * 6/2010 Chen et al. D13/147
D619,537 S * 7/2010 Cohen et al. D13/147
D637,956 S * 5/2011 Yuan et al. D13/147

* cited by examiner

Primary Examiner — Daniel Bui

(74) *Attorney, Agent, or Firm* — Fletcher Yoder; Scott Speroff; John M. Miller

(57) **CLAIM**

The ornamental design for a male communication connector of an automation device, as shown and described.

DESCRIPTION

FIG. 1 is a perspective view of a male communication connector of an automation device showing our new design; FIG. 2 is a front elevational view thereof; FIG. 3 is a left side elevational view thereof; FIG. 4 is a right side elevational view thereof; FIG. 5 is top plan view thereof; and, FIG. 6 is a bottom plan view thereof.

The even-broken line shown in the figure drawings is included for the purpose of illustrating environment and forms no part of the claimed design. The dash-dot broken line represents the boundary of the claimed design.

1 Claim, 5 Drawing Sheets

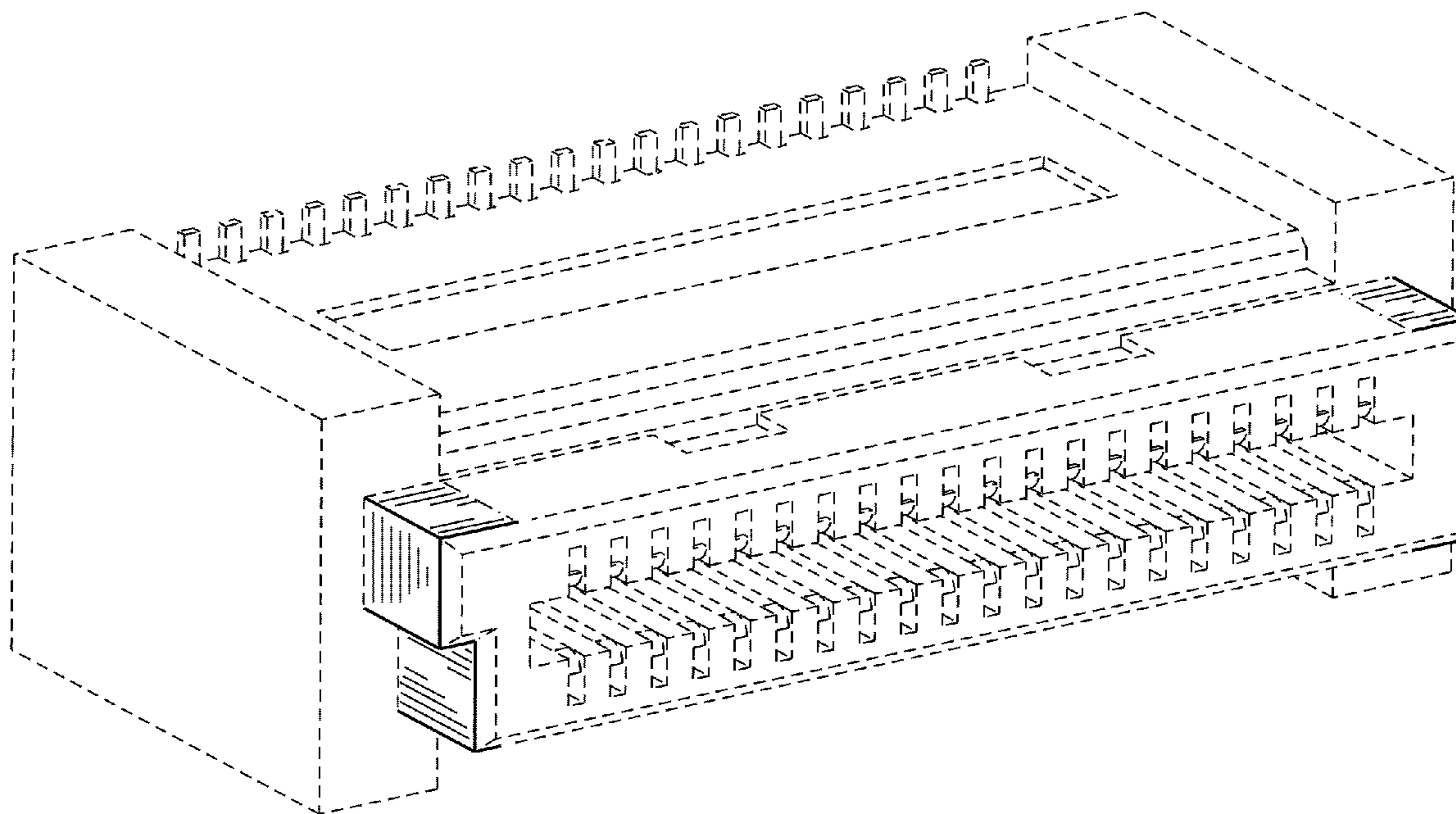

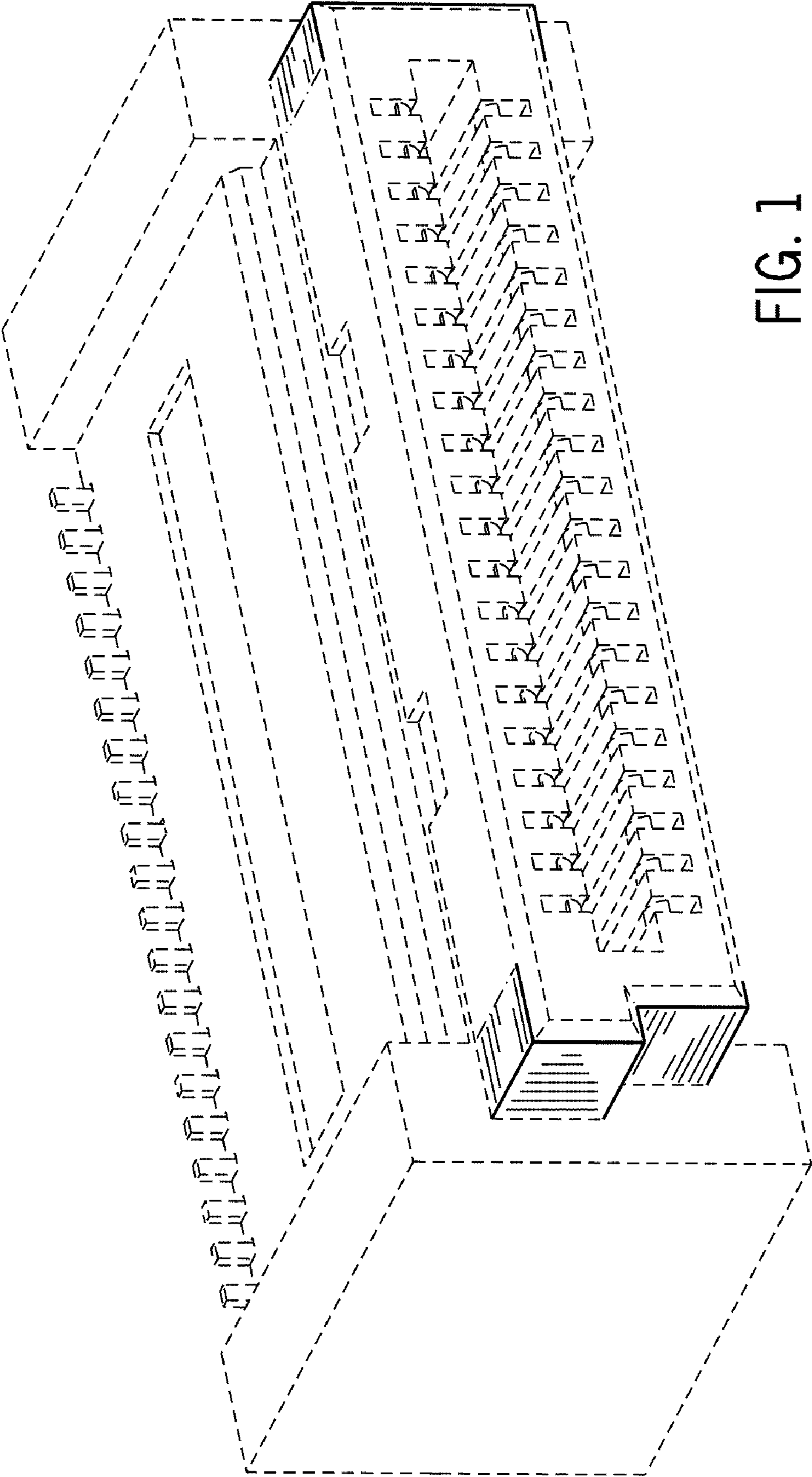

FIG. 1

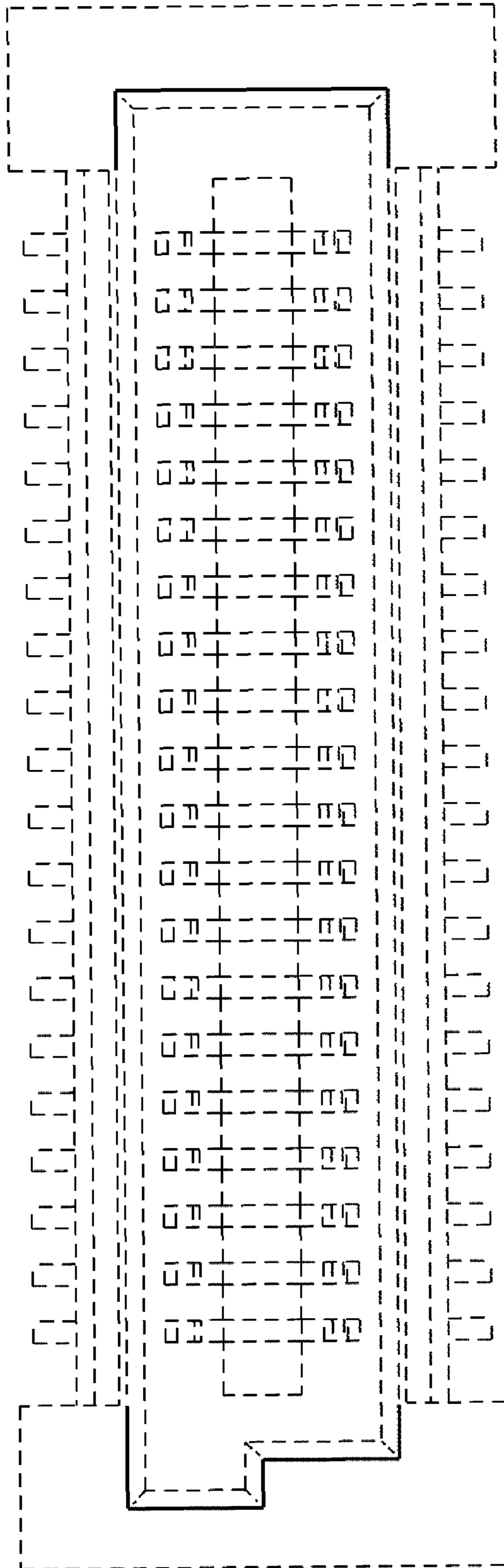
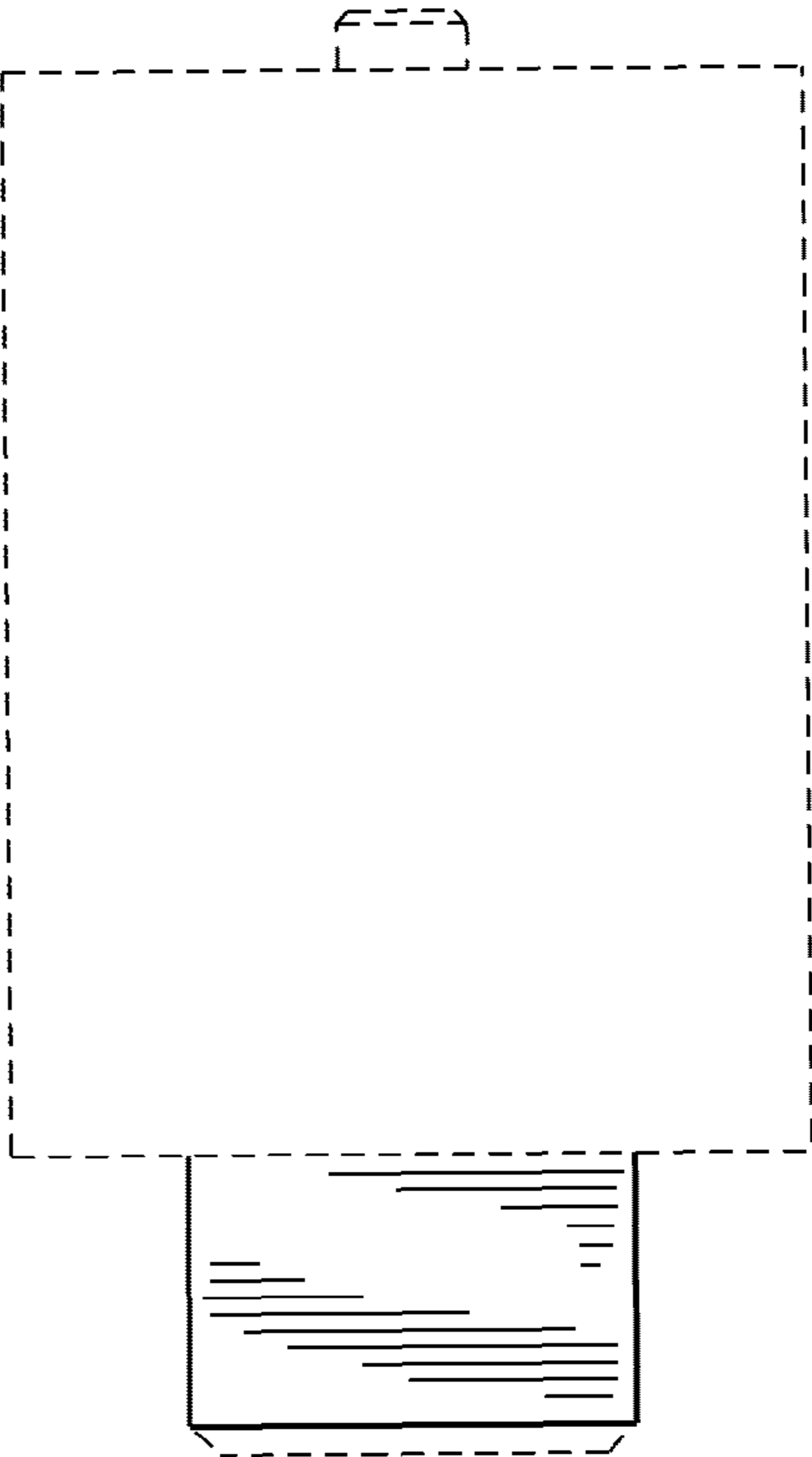
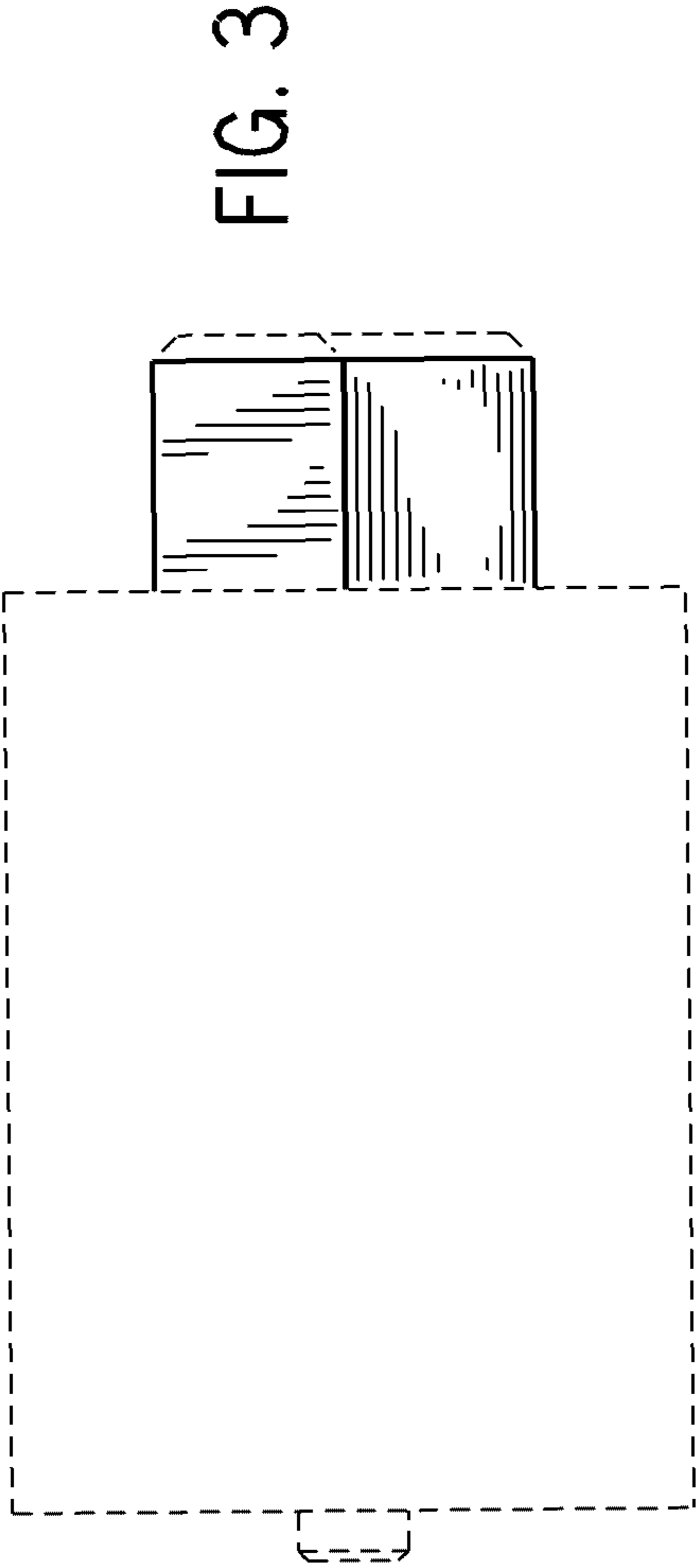

FIG. 2



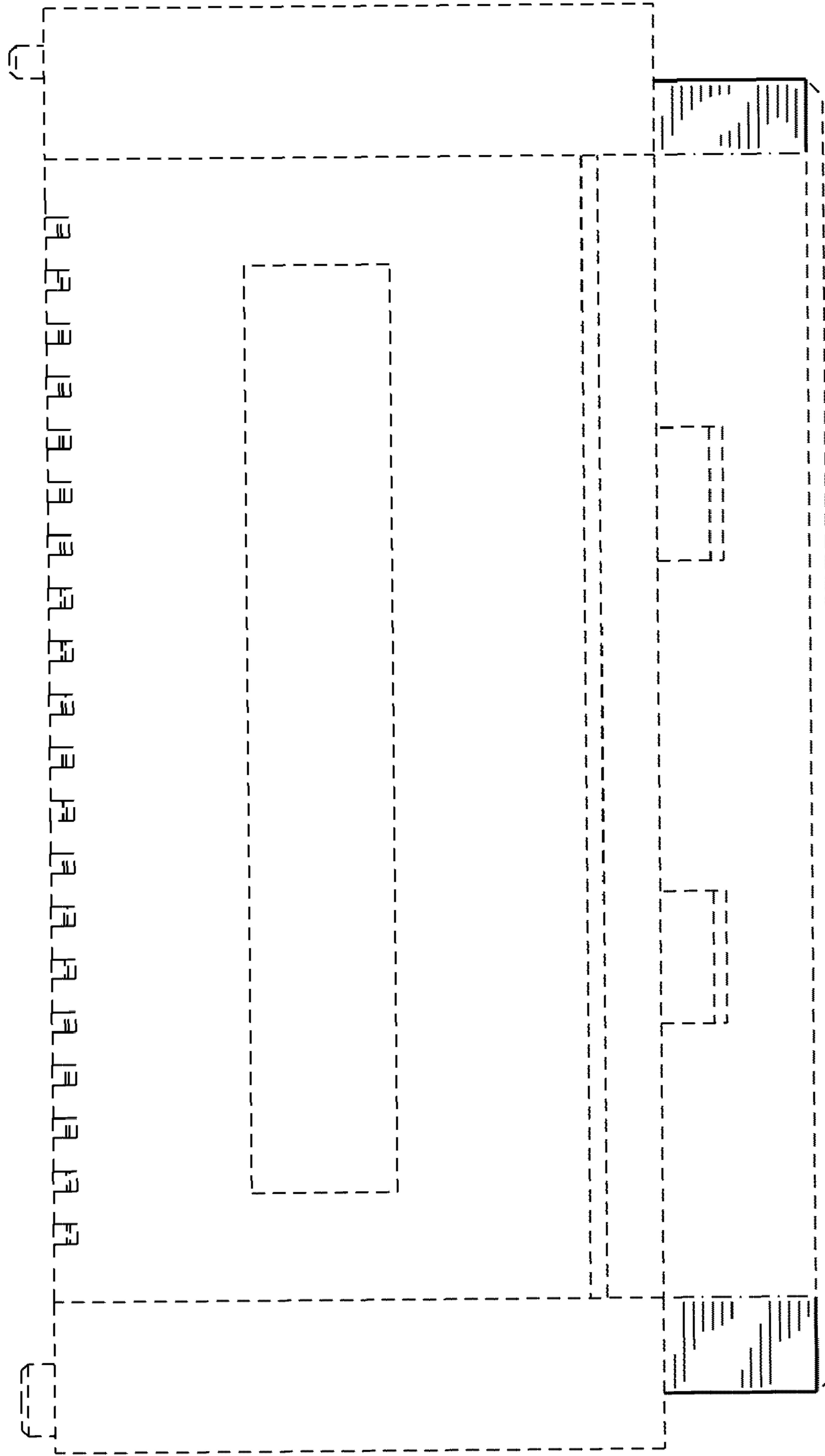

FIG. 5

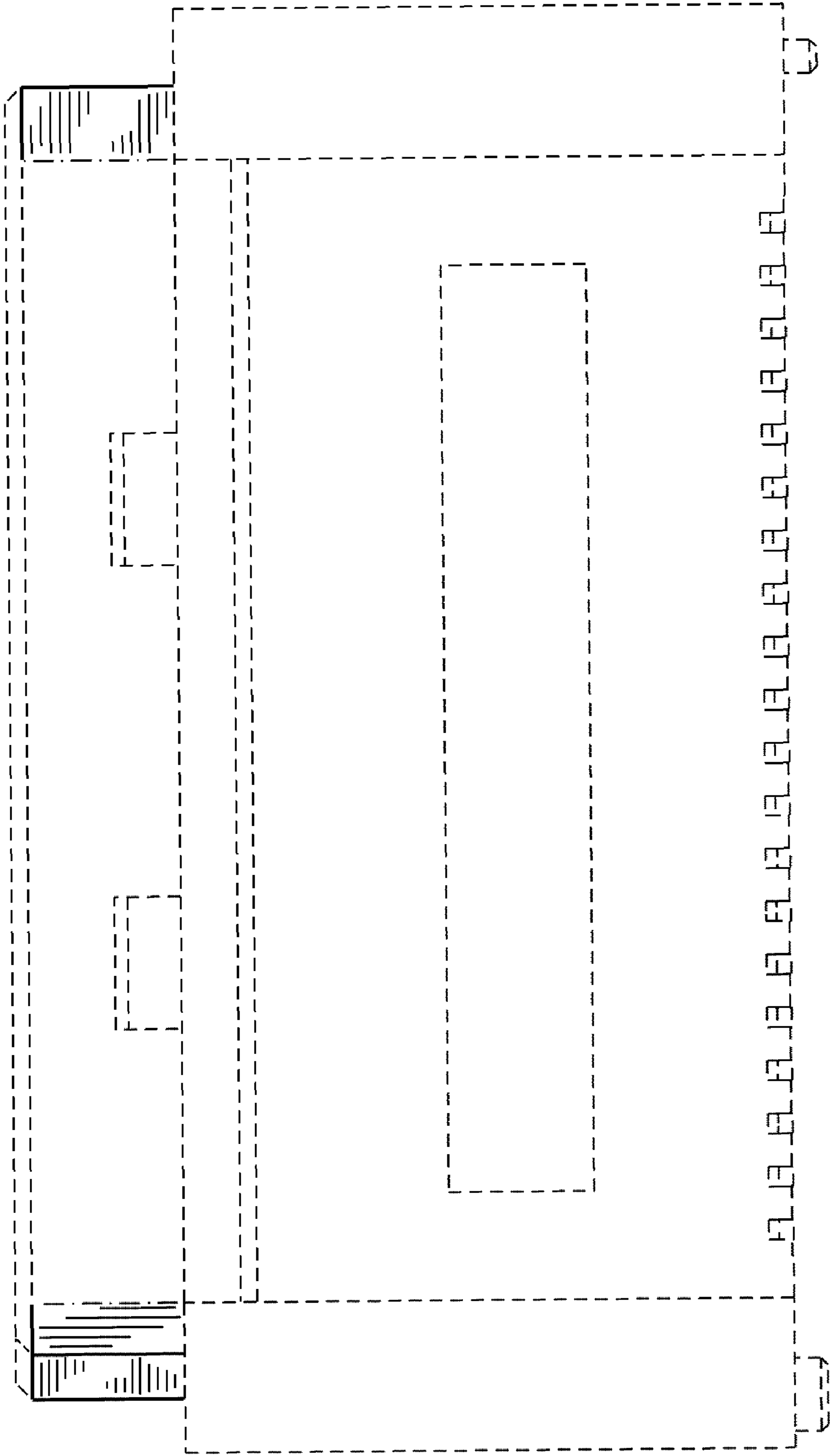

FIG. 6