



US00D650727S

(12) **United States Design Patent**
Balicki et al.

(10) **Patent No.:** **US D650,727 S**

(45) **Date of Patent:** **** Dec. 20, 2011**

(54) **A-PILLAR AIR DEFLECTOR FOR A TRUCK**

(75) Inventors: **Brian D. Balicki**, Kernersville, NC (US); **Ian Anderson**, Greensboro, NC (US); **Mathew Heinecke**, Kernersville, NC (US); **Glyn Haugh**, Greensboro, NC (US)

(73) Assignee: **Volvo Group North America, LLC**, Greensboro, NC (US)

(**) Term: **14 Years**

(21) Appl. No.: **29/393,385**

(22) Filed: **Jun. 3, 2011**

(51) **LOC (9) Cl.** **12-16**

(52) **U.S. Cl.** **D12/187**

(58) **Field of Classification Search** D12/187, D12/188-189; D6/300, 309; 359/838, 841, 359/842, 843, 844, 868, 871, 604, 881, 514, 359/866; 248/479-483, 475.1

See application file for complete search history.

(56) **References Cited**

U.S. PATENT DOCUMENTS

| | | | | | | |
|-----------|---|---|---------|--------------|-------|---------|
| 3,371,903 | A | * | 3/1968 | Thompson | | 248/486 |
| D320,592 | S | * | 10/1991 | Straka | | D12/190 |
| D385,243 | S | * | 10/1997 | Lang | | D12/188 |
| D387,317 | S | * | 12/1997 | Lang | | D12/187 |
| D407,361 | S | * | 3/1999 | Lang | | D12/187 |
| D460,393 | S | * | 7/2002 | Kidd | | D12/188 |
| D462,642 | S | * | 9/2002 | Kostelnik | | D12/188 |
| D468,681 | S | * | 1/2003 | Rath | | D12/400 |
| D505,901 | S | * | 6/2005 | Wang | | D12/203 |
| D512,355 | S | * | 12/2005 | Courbon | | D12/187 |
| D585,243 | S | * | 1/2009 | Frank | | D7/570 |
| D610,060 | S | * | 2/2010 | Meier et al. | | D12/187 |

* cited by examiner

Primary Examiner — Caron D Veynar

Assistant Examiner — Katrina A Betton

(74) *Attorney, Agent, or Firm* — Martin Farrell; Michael Pruden

(57) **CLAIM**

The ornamental design of an A-pillar air deflector for a truck, as shown and described herein.

DESCRIPTION

FIG. 1 is a perspective view of an embodiment for a right side of a truck of an A-pillar air deflector for a truck showing our new design;

FIG. 2 is a right side view thereof;

FIG. 3 is a left side view thereof;

FIG. 4 is a top view thereof;

FIG. 5 is a bottom view thereof;

FIG. 6 is a front view thereof;

FIG. 7 is a rear view thereof;

FIG. 8 is a perspective view of an A-pillar air deflector of our new design shown in its environment on a truck;

FIG. 9 is a perspective view of an embodiment for a left side of a truck of an A-pillar air deflector for a truck showing our new design;

FIG. 10 is a left side view thereof;

FIG. 11 is a right side view thereof;

FIG. 12 is a top view thereof;

FIG. 13 is a bottom view thereof;

FIG. 14 is a front view thereof;

FIG. 15 is a rear view thereof; and,

FIG. 16 is a perspective view of a left hand A-pillar air deflector of our new design shown in its environment on a truck.

In the drawings, the broken lines depict environmental subject matter only and form no part of the claimed design.

1 Claim, 14 Drawing Sheets

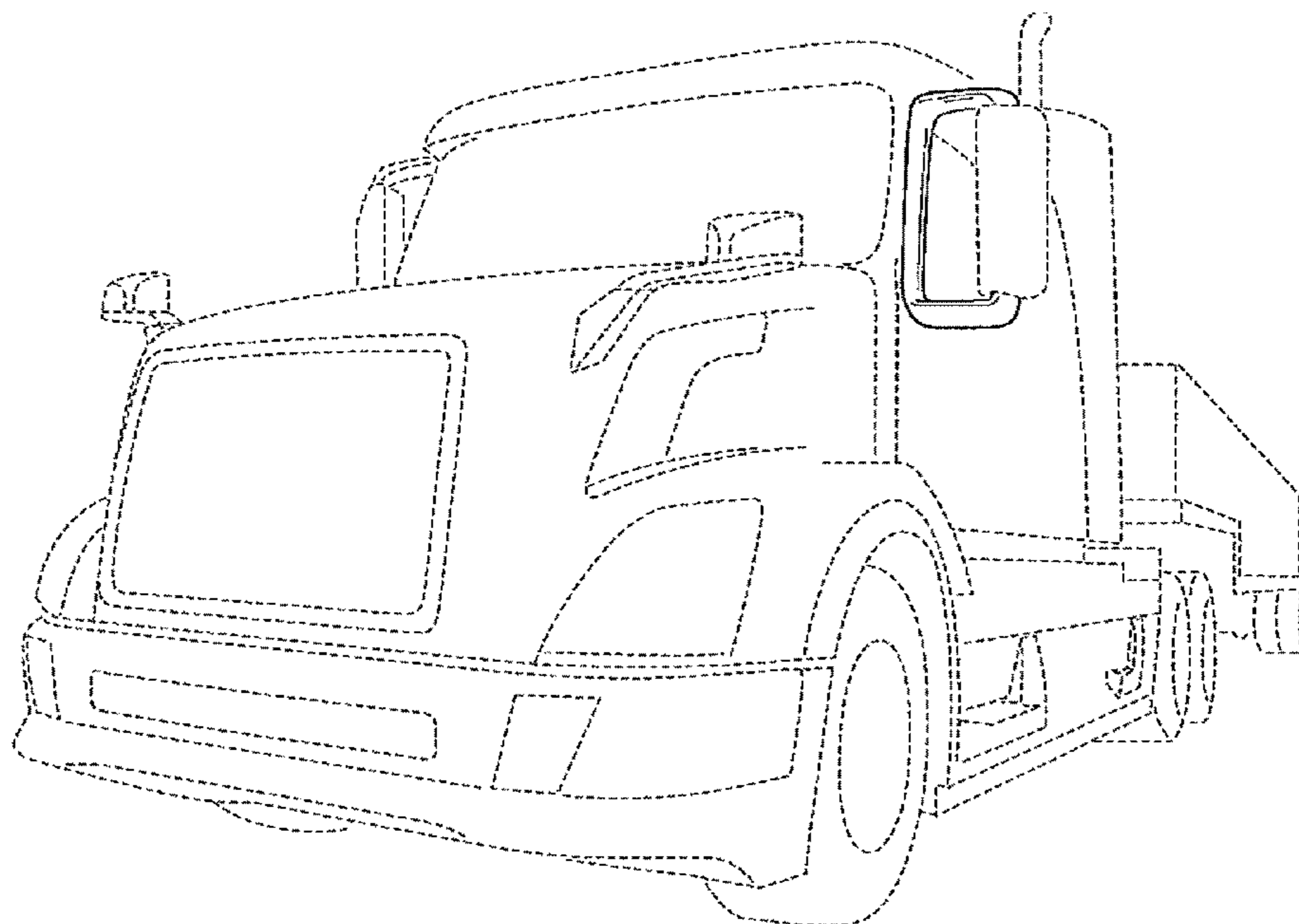

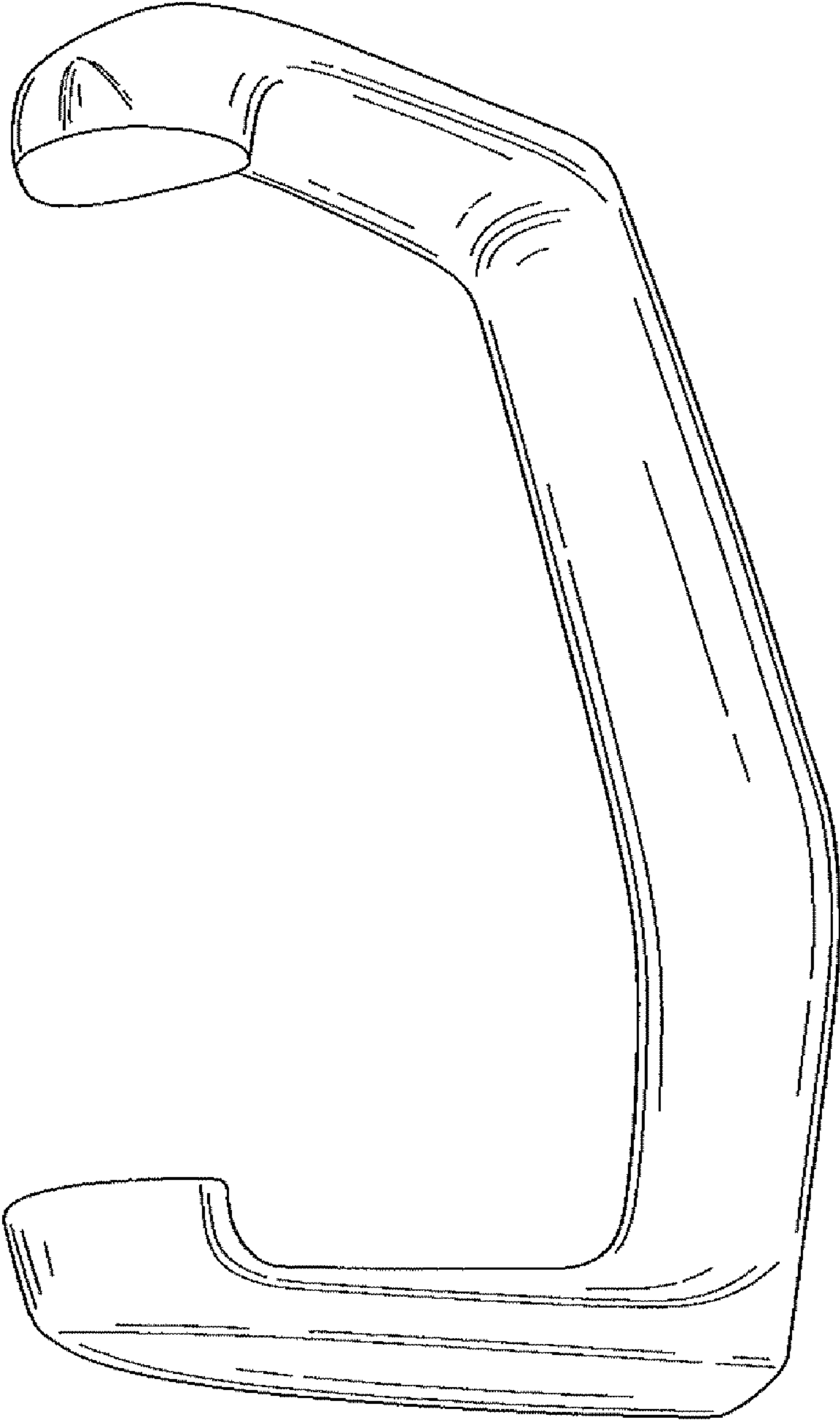

FIG. 1



FIG. 2

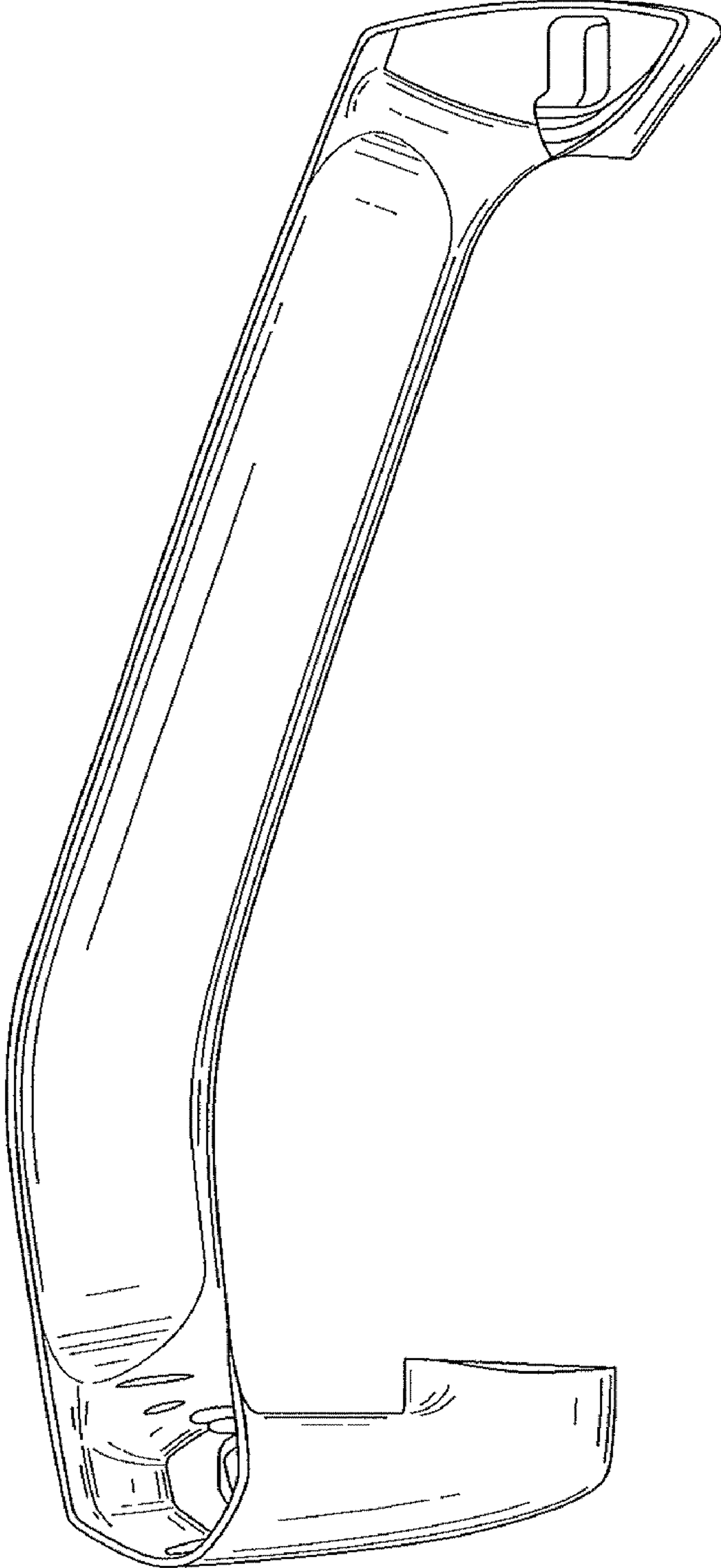

FIG. 3

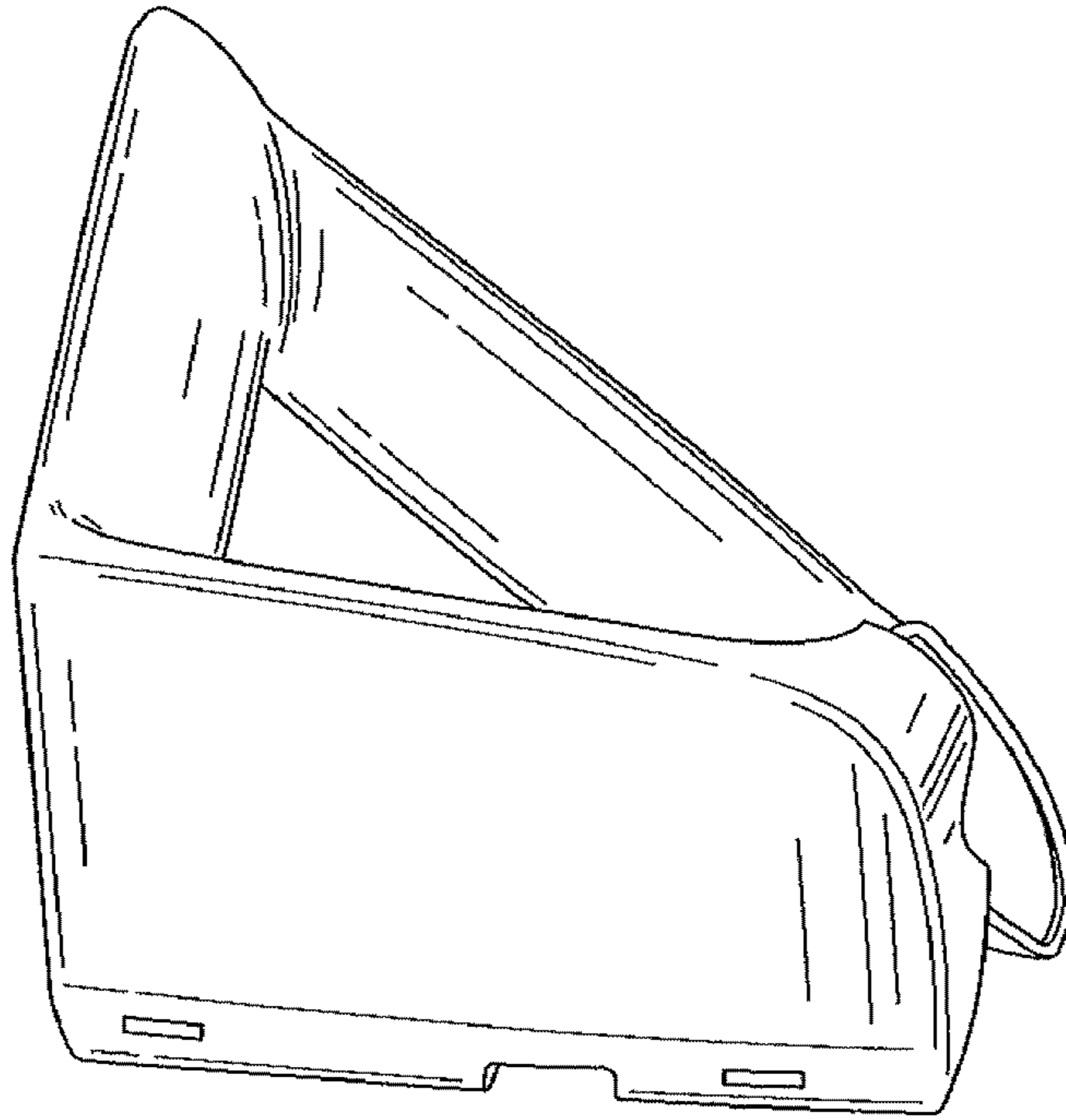

FIG. 4

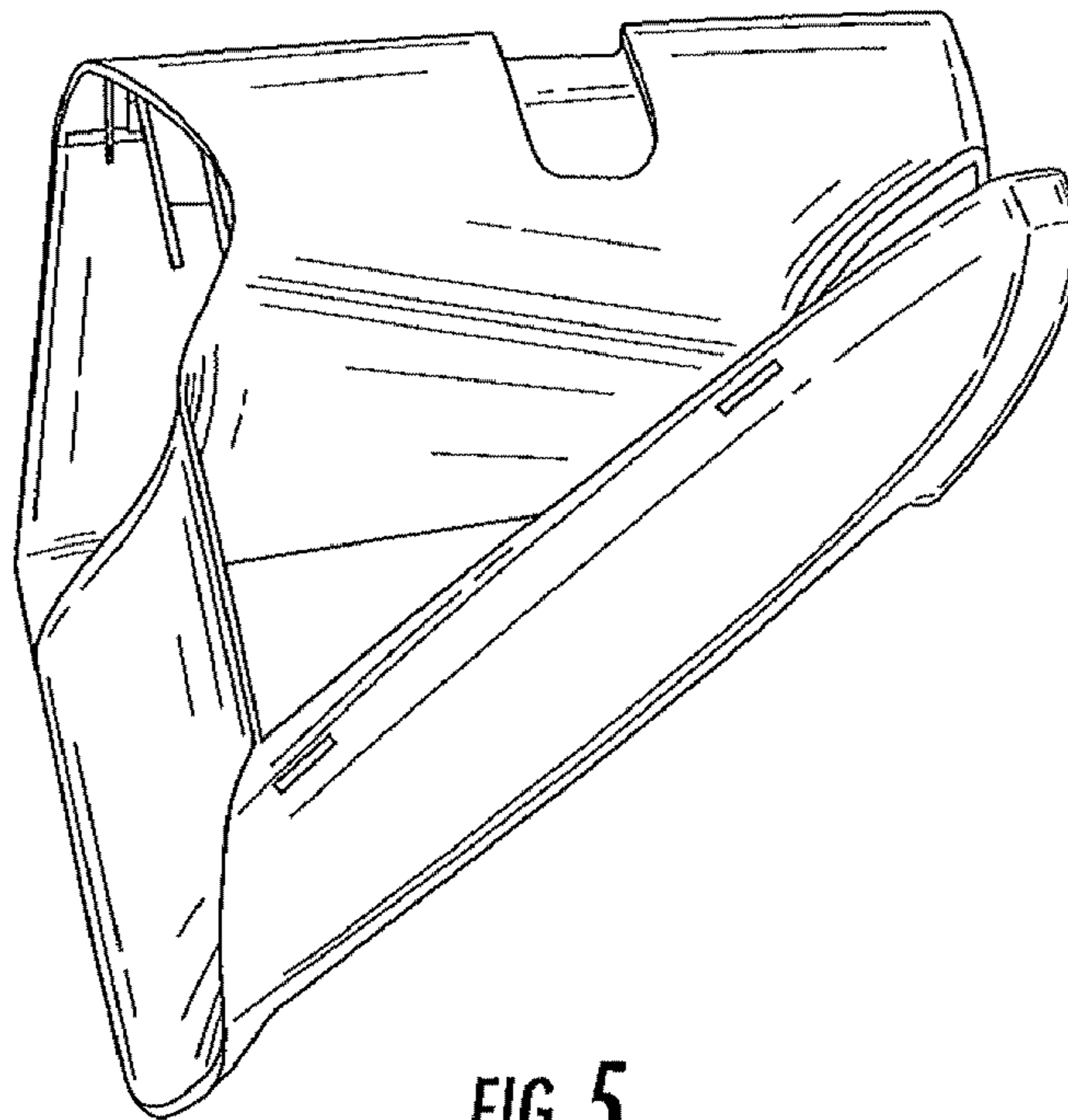

FIG. 5

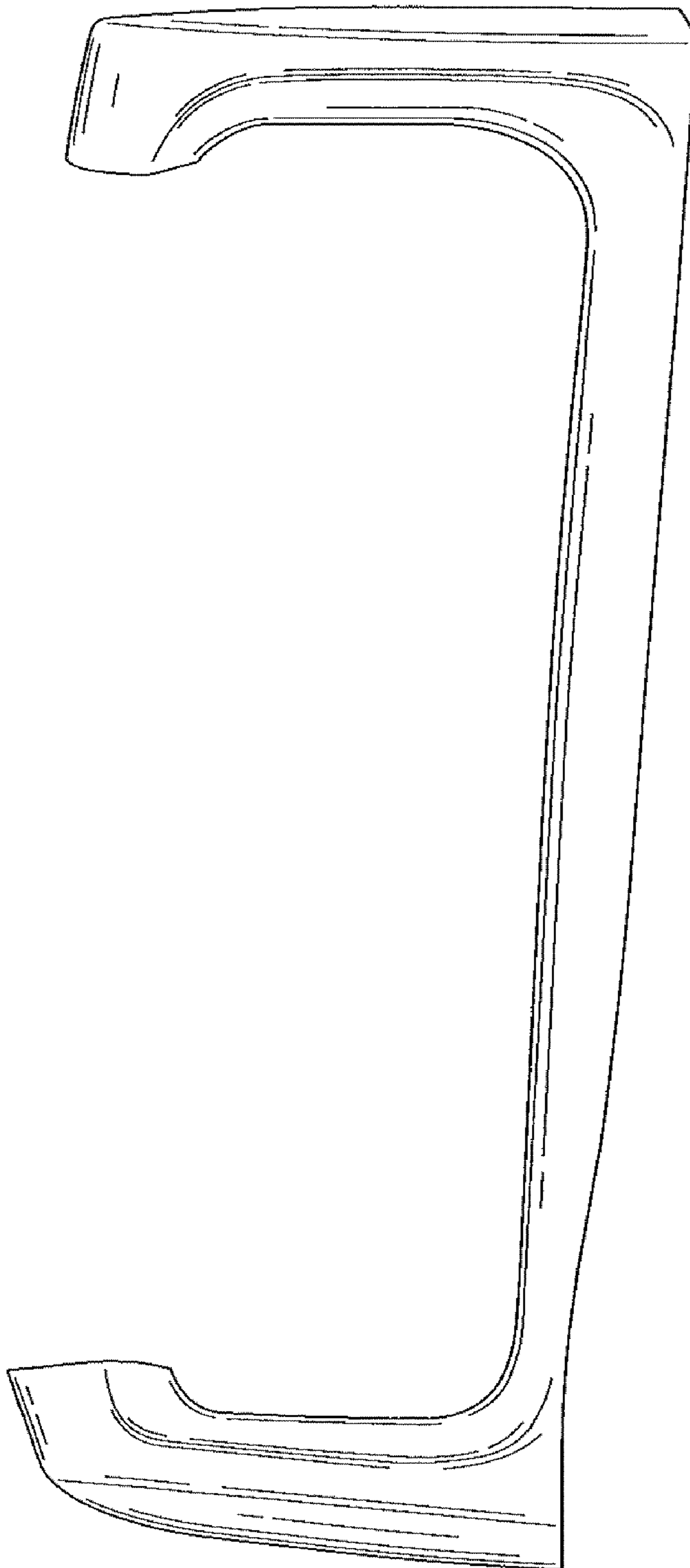

FIG. 6

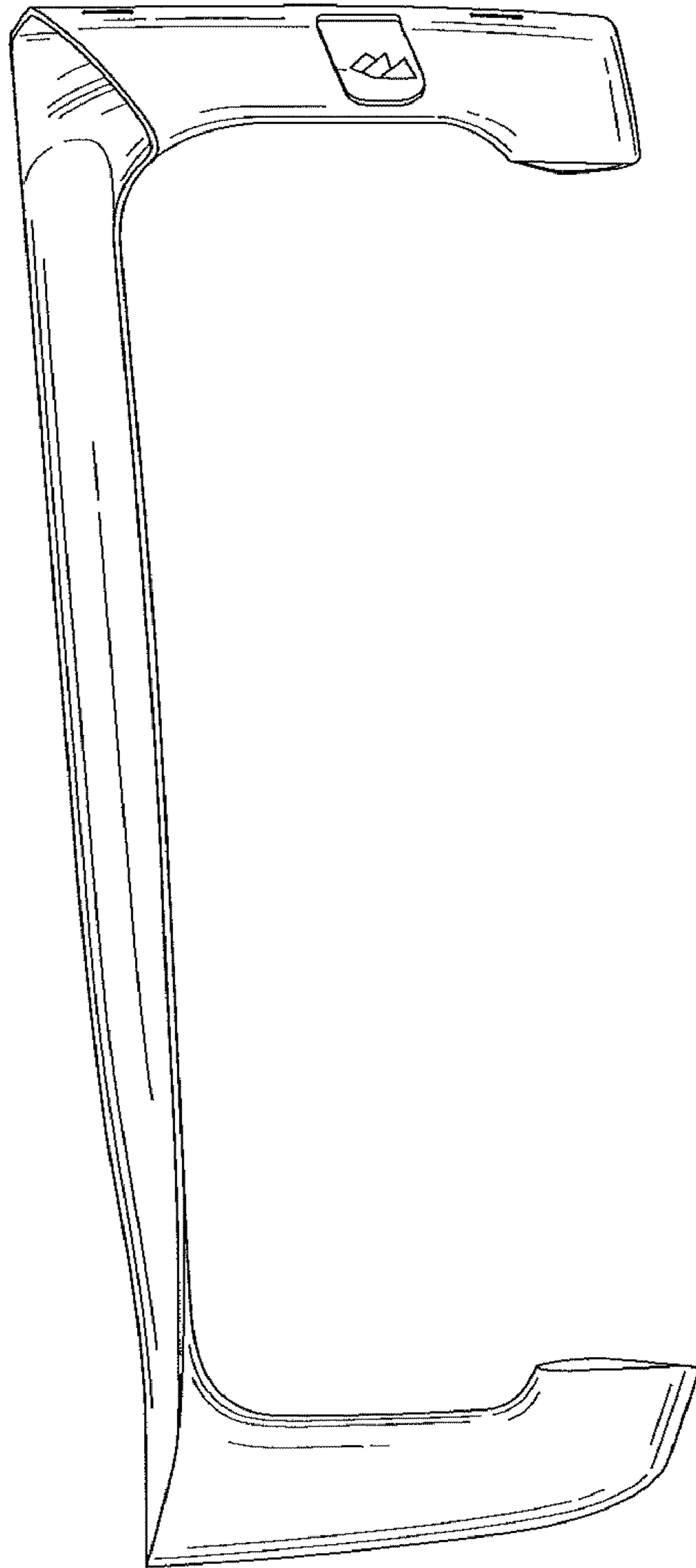

FIG. 7

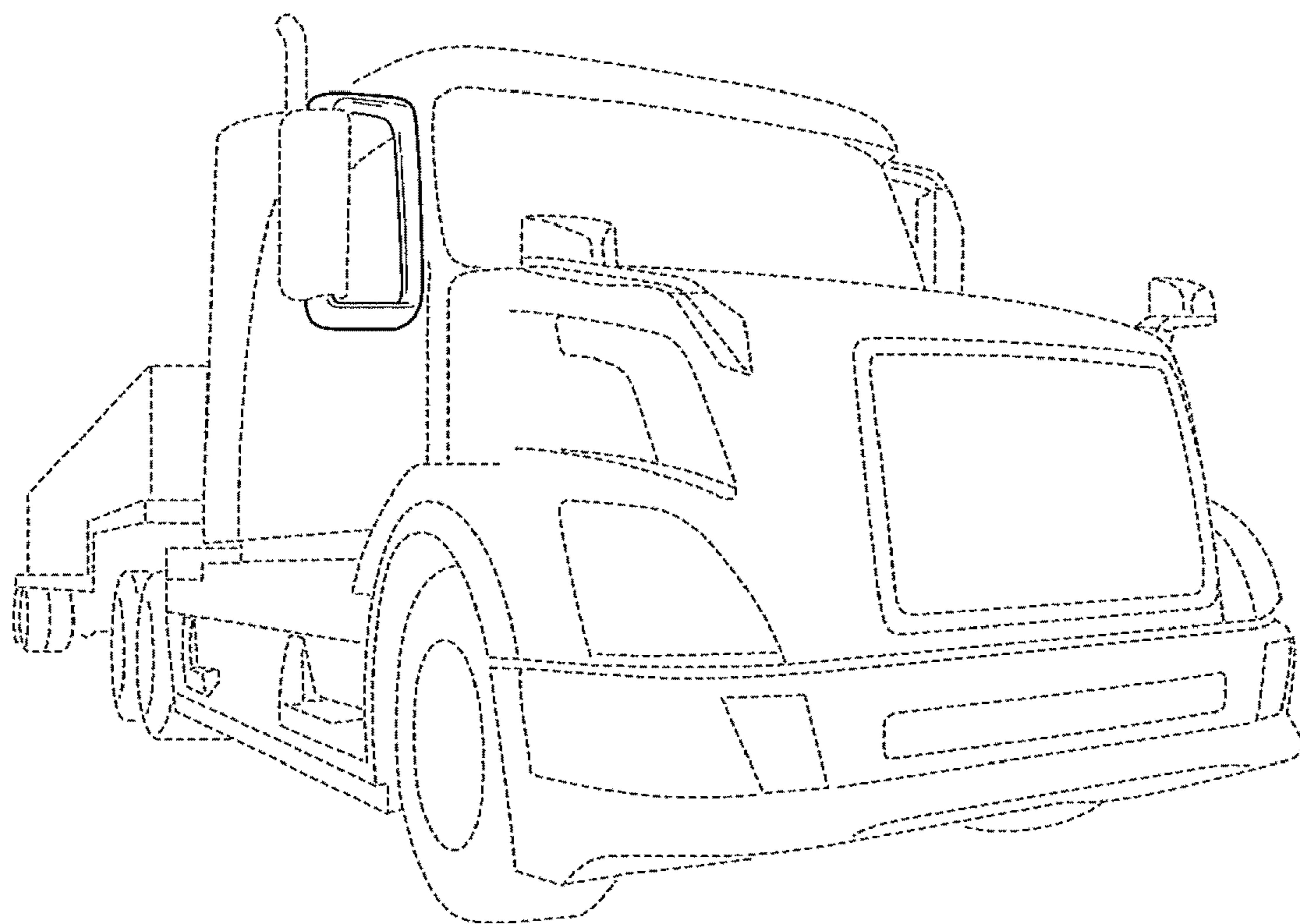

FIG. 8



FIG. 9

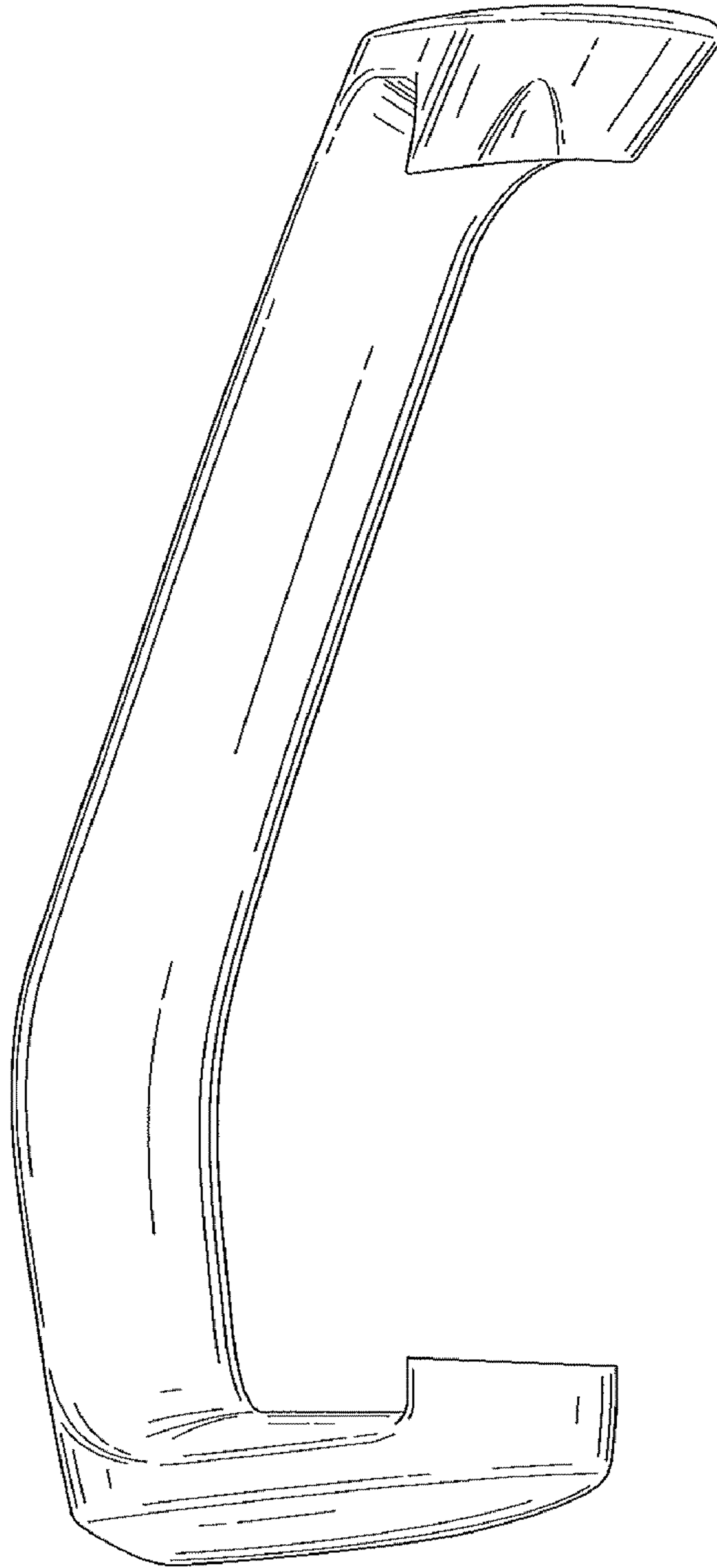

FIG. 10

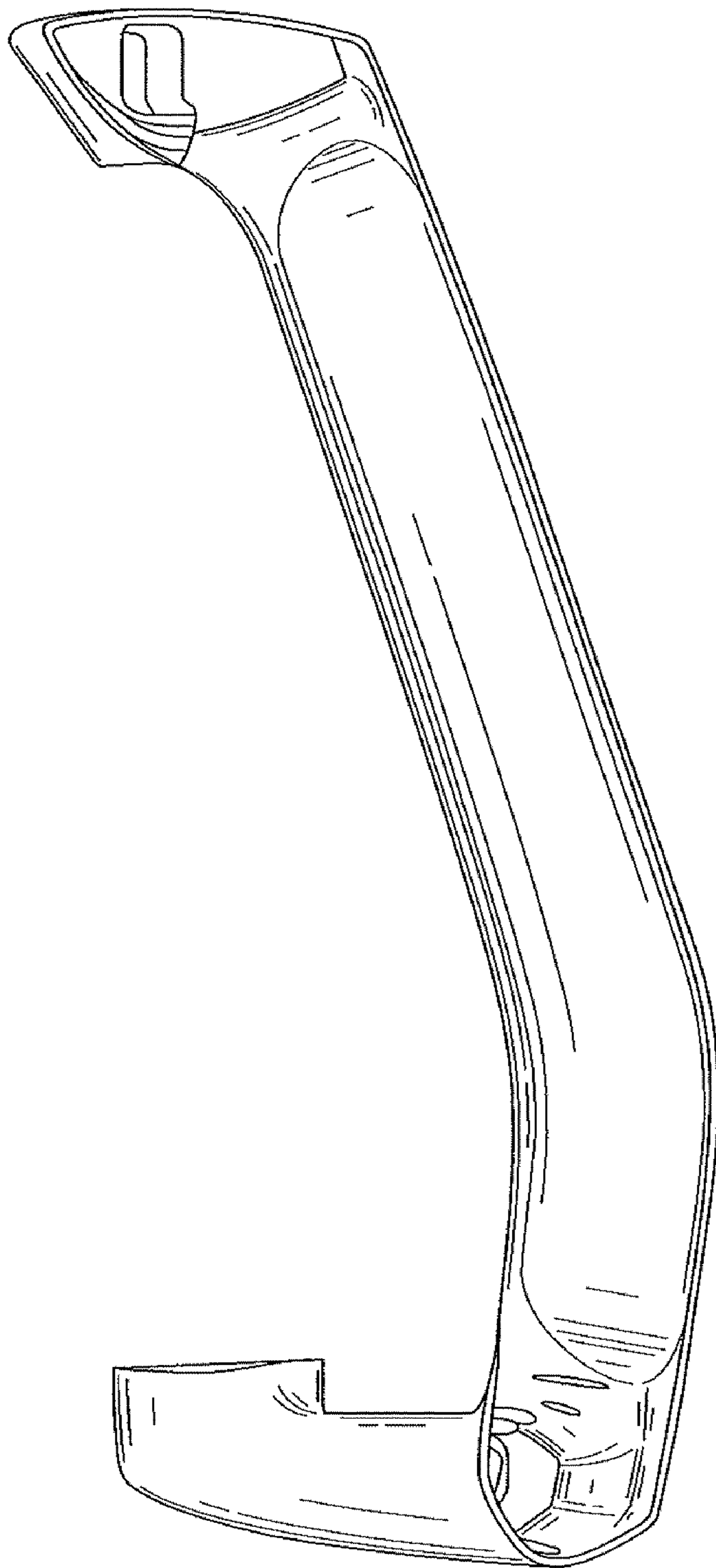

FIG. 11

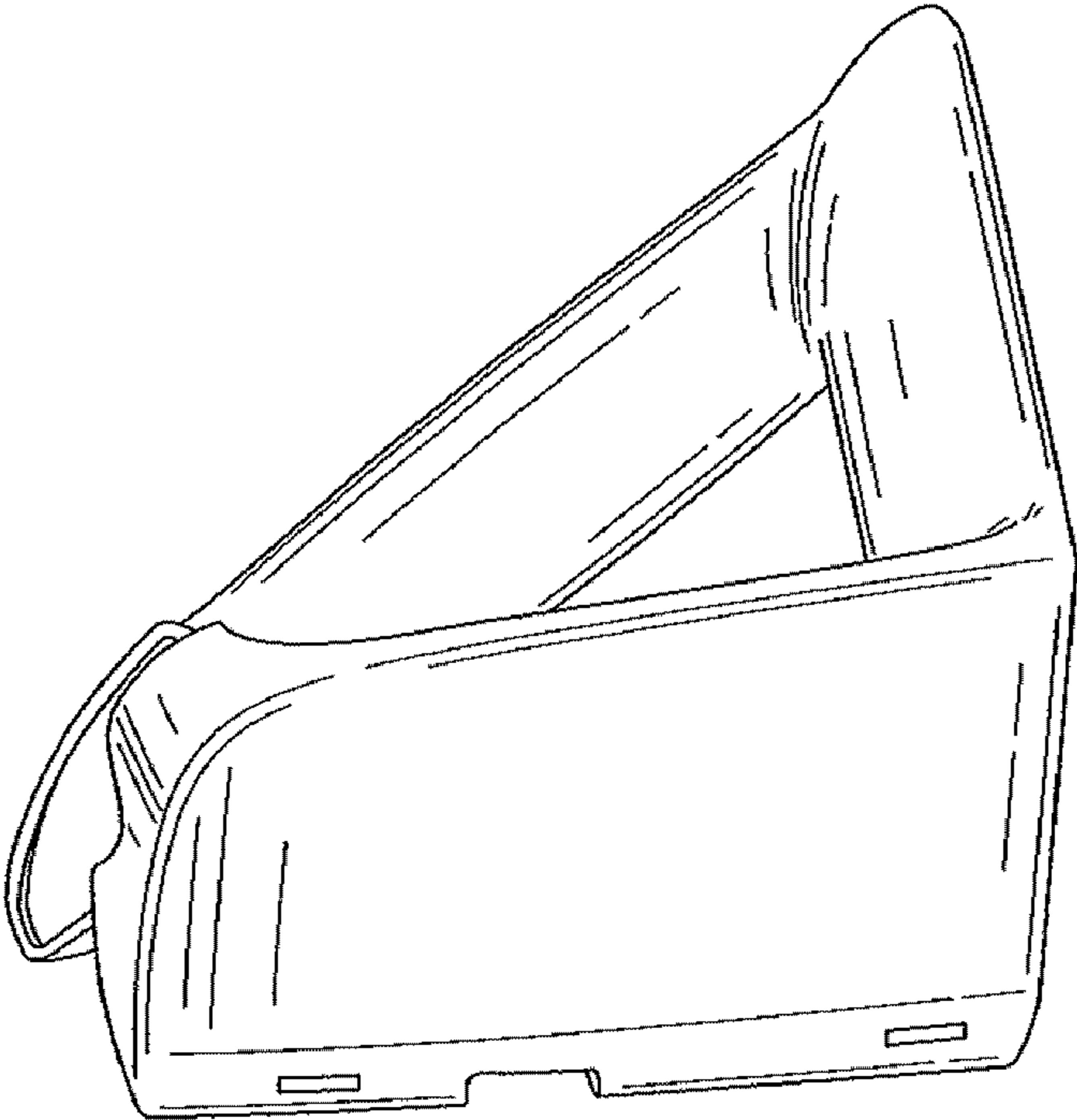

FIG. 12

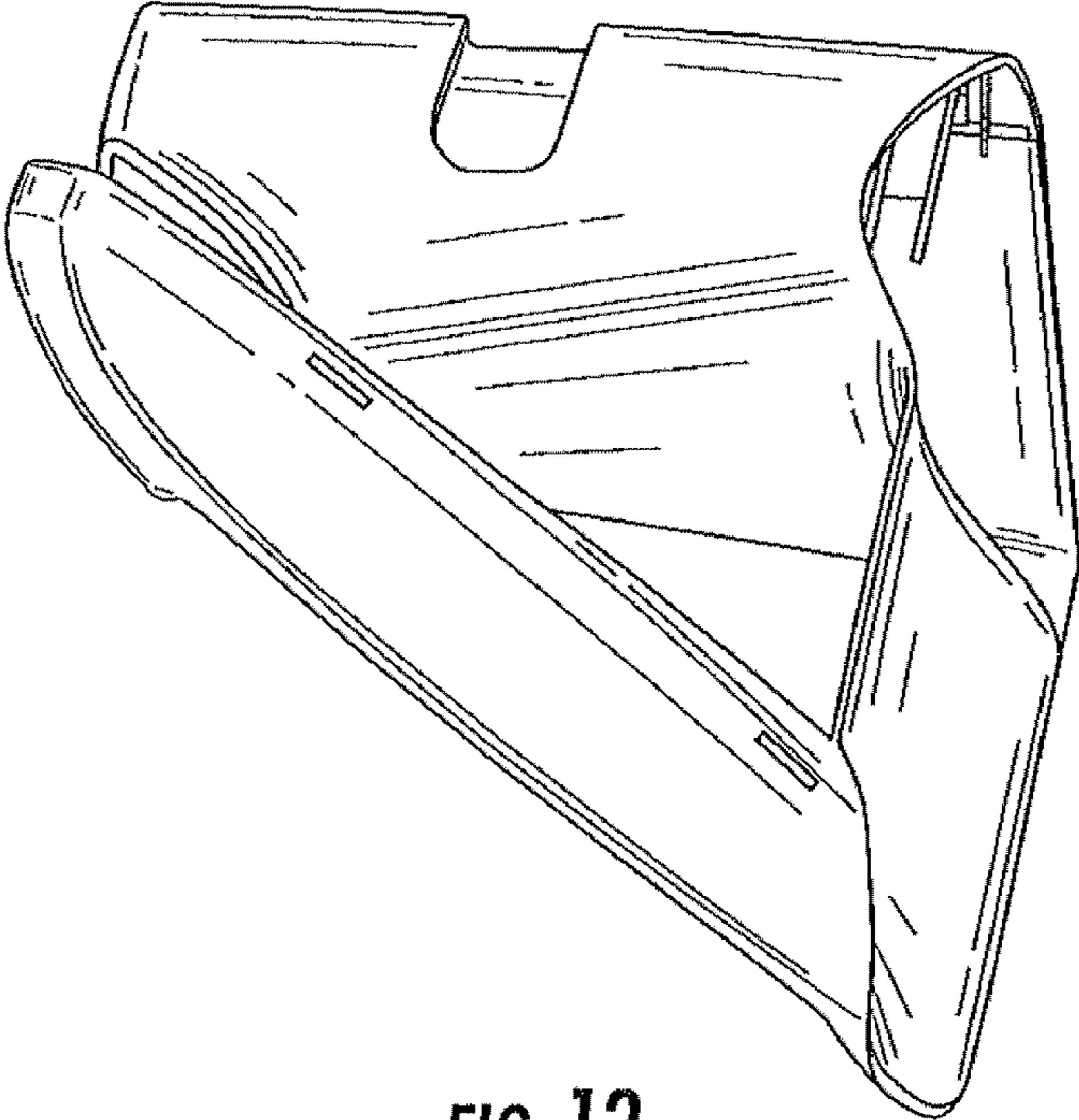

FIG. 13

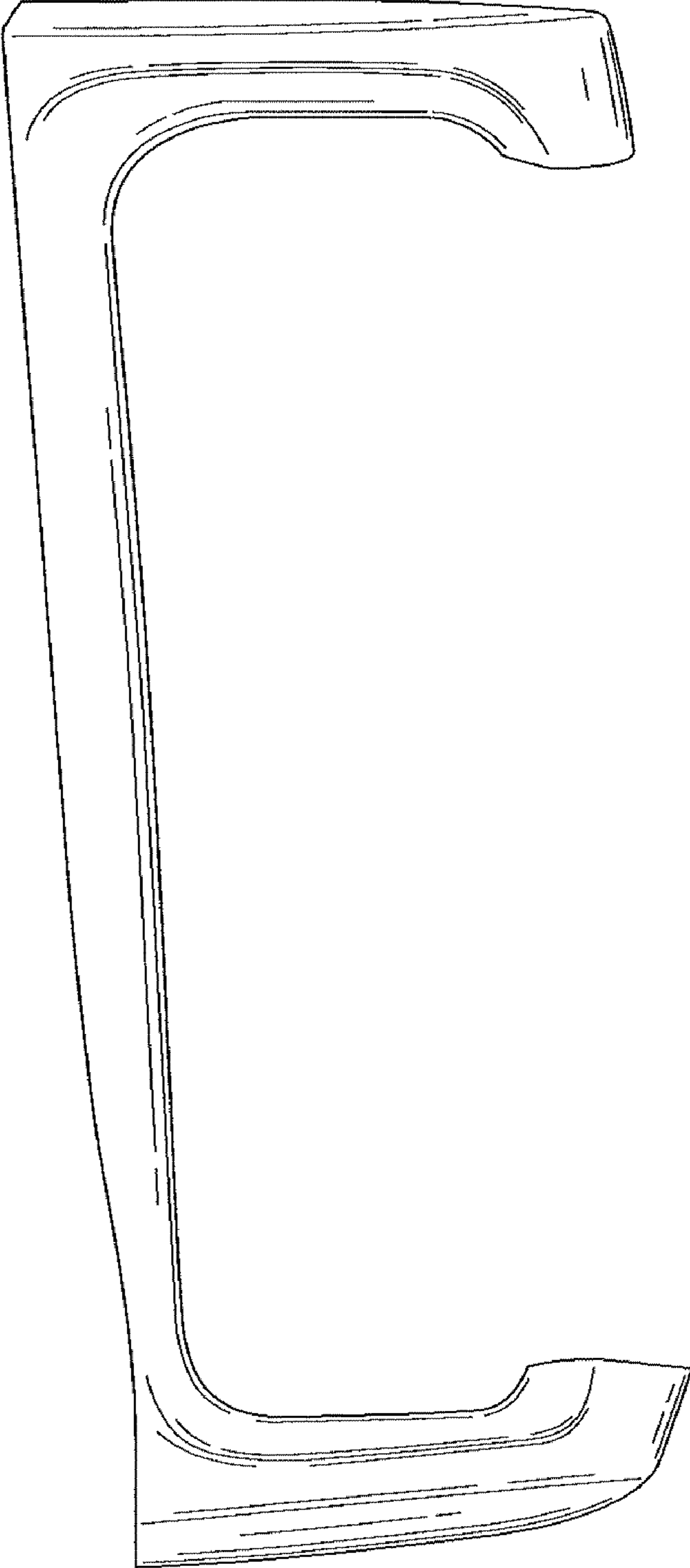

FIG. 14

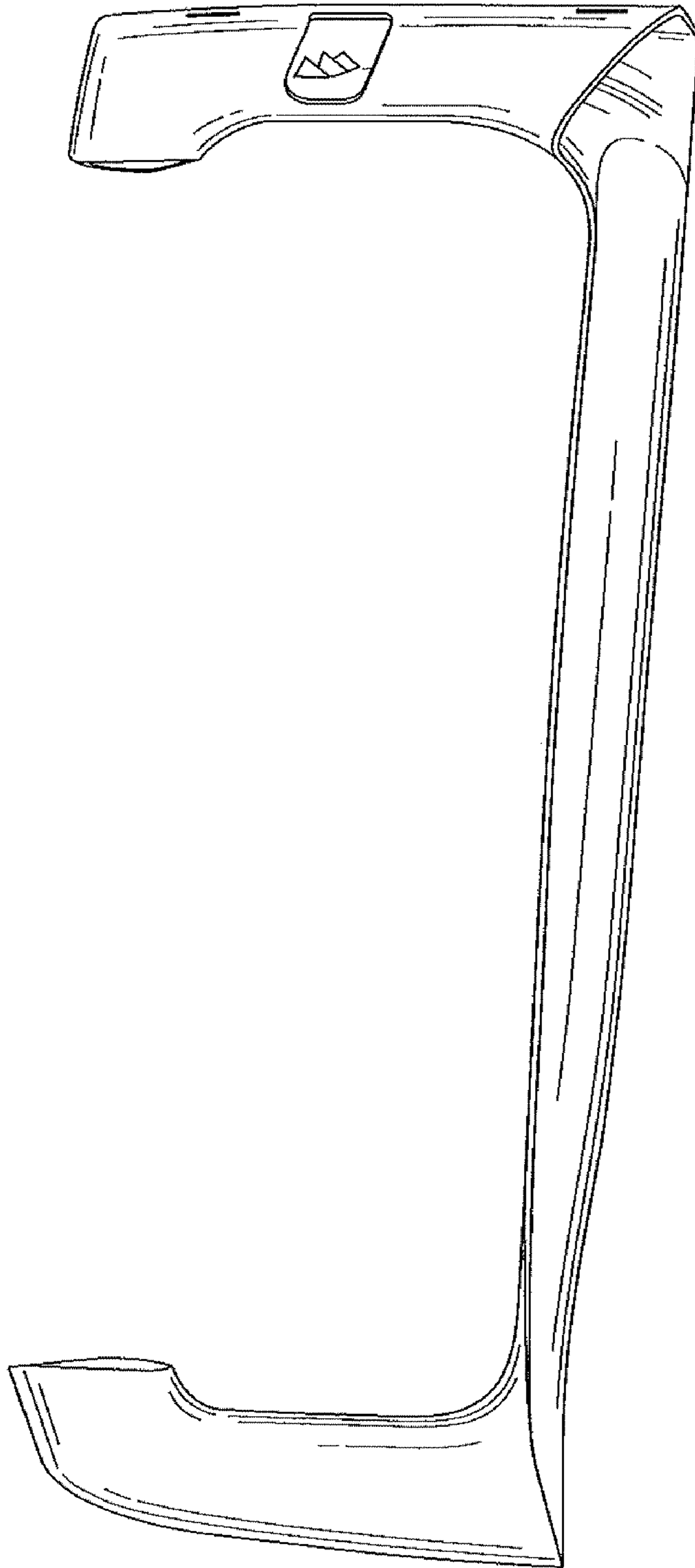

FIG. 15

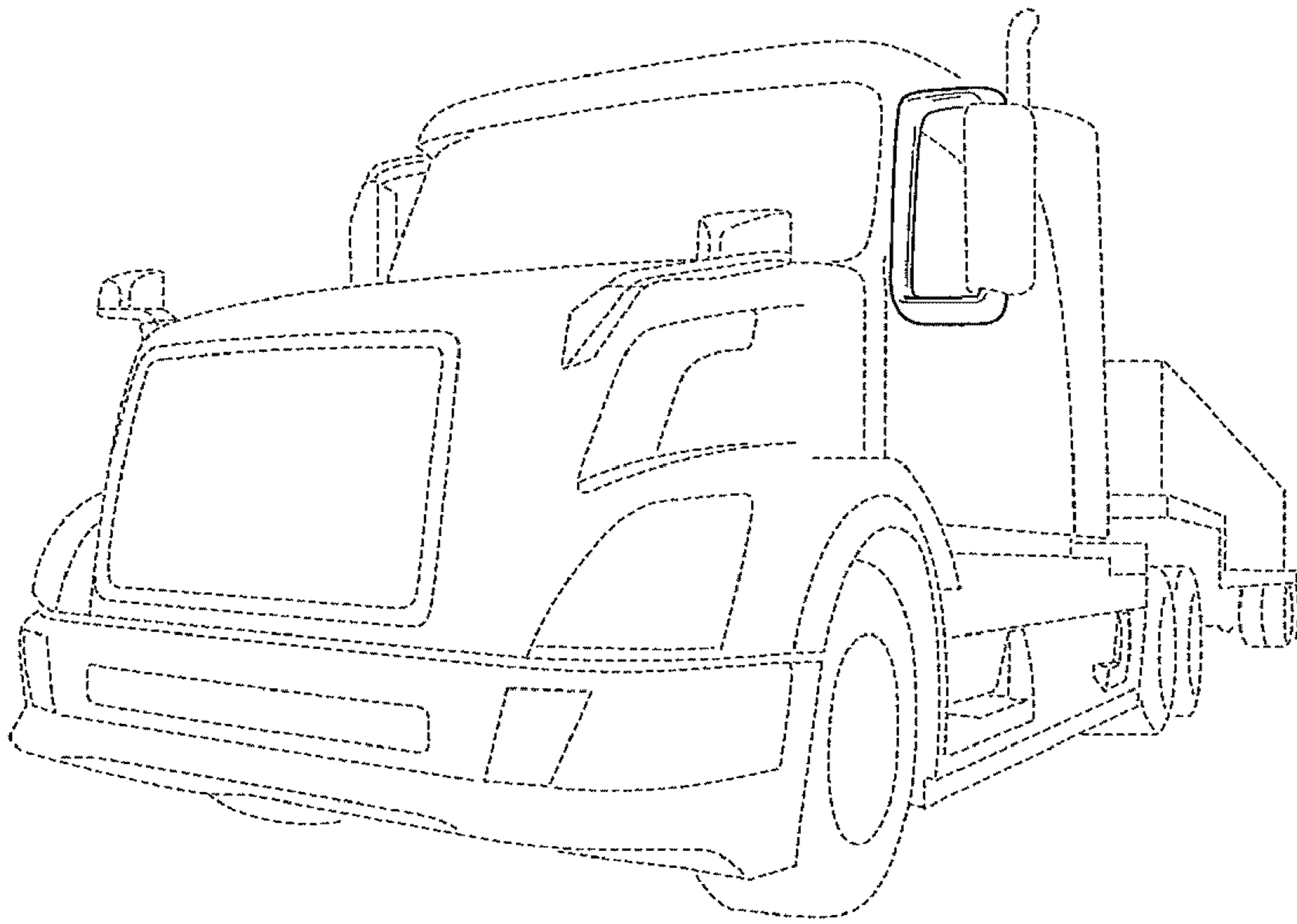

FIG. 16