



US00D650726S

(12) **United States Design Patent**  
**Balicki et al.**

(10) **Patent No.:** **US D650,726 S**  
(45) **Date of Patent:** **\*\* Dec. 20, 2011**

(54) **UNDER BUMPER AIR DEFLECTOR FOR A TRUCK**

FOREIGN PATENT DOCUMENTS

GB 2051691 A 1/1981

\* cited by examiner

(75) Inventors: **Brian D. Balicki**, Kernersville, NC (US); **James Bird**, Oak Ridge, NC (US)

*Primary Examiner* — Caron D Veynar

*Assistant Examiner* — Katrina A Betton

(73) Assignee: **Volvo Group North America, LLC**, Greensboro, NC (US)

(74) *Attorney, Agent, or Firm* — Martin Farrell Michael Pruden

(\*\*) Term: **14 Years**

(57) **CLAIM**

The ornamental design of an under bumper air deflector for a truck, as shown and described.

(21) Appl. No.: **29/393,383**

**DESCRIPTION**

(22) Filed: **Jun. 3, 2011**

(51) **LOC (9) Cl.** ..... **12-08**

(52) **U.S. Cl.** ..... **D12/181**

(58) **Field of Classification Search** ..... D12/181, D12/191, 196, 400, 190, 88; 280/727, 770, 280/848; 296/180.1–180.5, 91; 180/903  
See application file for complete search history.

FIG. 1 is a perspective view from the front of an embodiment for a left side of a truck of an under bumper air deflector for a truck showing our new design;  
FIG. 2 is a perspective view from the rear thereof;  
FIG. 3 is a front view thereof;  
FIG. 4 is a rear view thereof;  
FIG. 5 is a left side view thereof;  
FIG. 6 is a right view thereof;  
FIG. 7 is a top view thereof;  
FIG. 8 is a bottom view thereof;  
FIG. 9 is a perspective view from the front of an embodiment for a right side of a truck of an under bumper air deflector for a truck showing our new design;  
FIG. 10 is a perspective view from the rear thereof;  
FIG. 11 is a front view thereof;  
FIG. 12 is a rear view thereof;  
FIG. 13 is a right view thereof;  
FIG. 14 is a left view thereof;  
FIG. 15 is a top view thereof; and,  
FIG. 16 is a bottom view thereof.

(56) **References Cited**

U.S. PATENT DOCUMENTS

4,810,021	A	3/1989	Burst	
5,511,847	A	4/1996	Weisbarth et al.	
D431,511	S *	10/2000	Damon et al.	D12/196
D431,806	S *	10/2000	Damon et al.	D12/196
D433,980	S *	11/2000	Conway et al.	D12/196
D434,358	S *	11/2000	Conway et al.	D12/196
D502,904	S *	3/2005	Delashaw et al.	D12/184
D511,727	S *	11/2005	Shaw et al.	D12/184
D524,204	S *	7/2006	Beigel	D12/184
D540,727	S *	4/2007	Elliott et al.	D12/196
7,380,869	B2	6/2008	Nakaya	
D621,756	S *	8/2010	Angelo et al.	D12/184
D643,352	S *	8/2011	Hjorten et al.	D12/181
2008/0001390	A1 *	1/2008	Iverson	280/848
2008/0185869	A1 *	8/2008	Stegawski et al.	296/180.1
2010/0307240	A1 *	12/2010	Tezuka et al.	73/494

In the drawings, the broken lines depict environmental subject matter only and form no part of the claimed design.

**1 Claim, 16 Drawing Sheets**

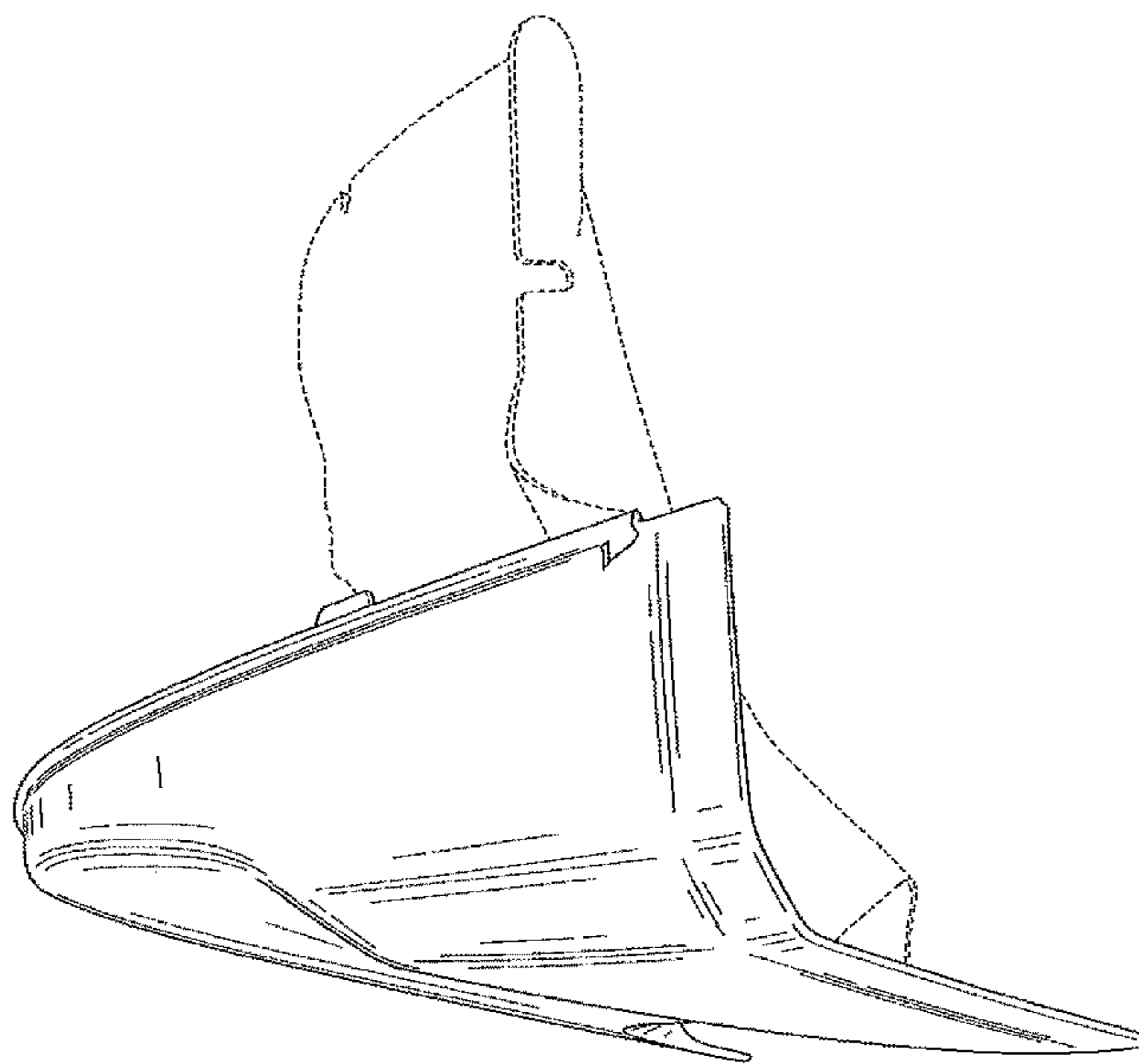

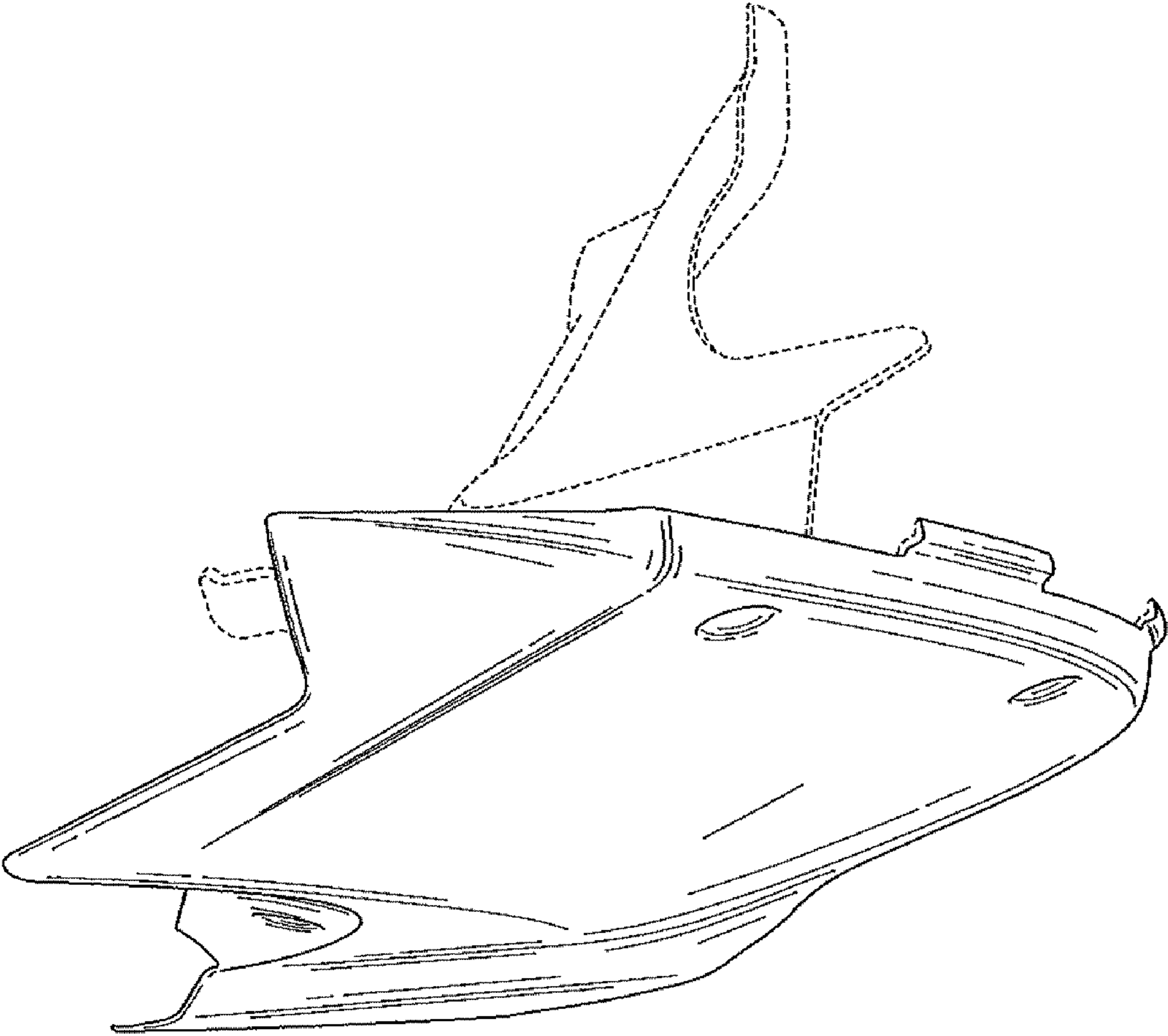

FIG. 1

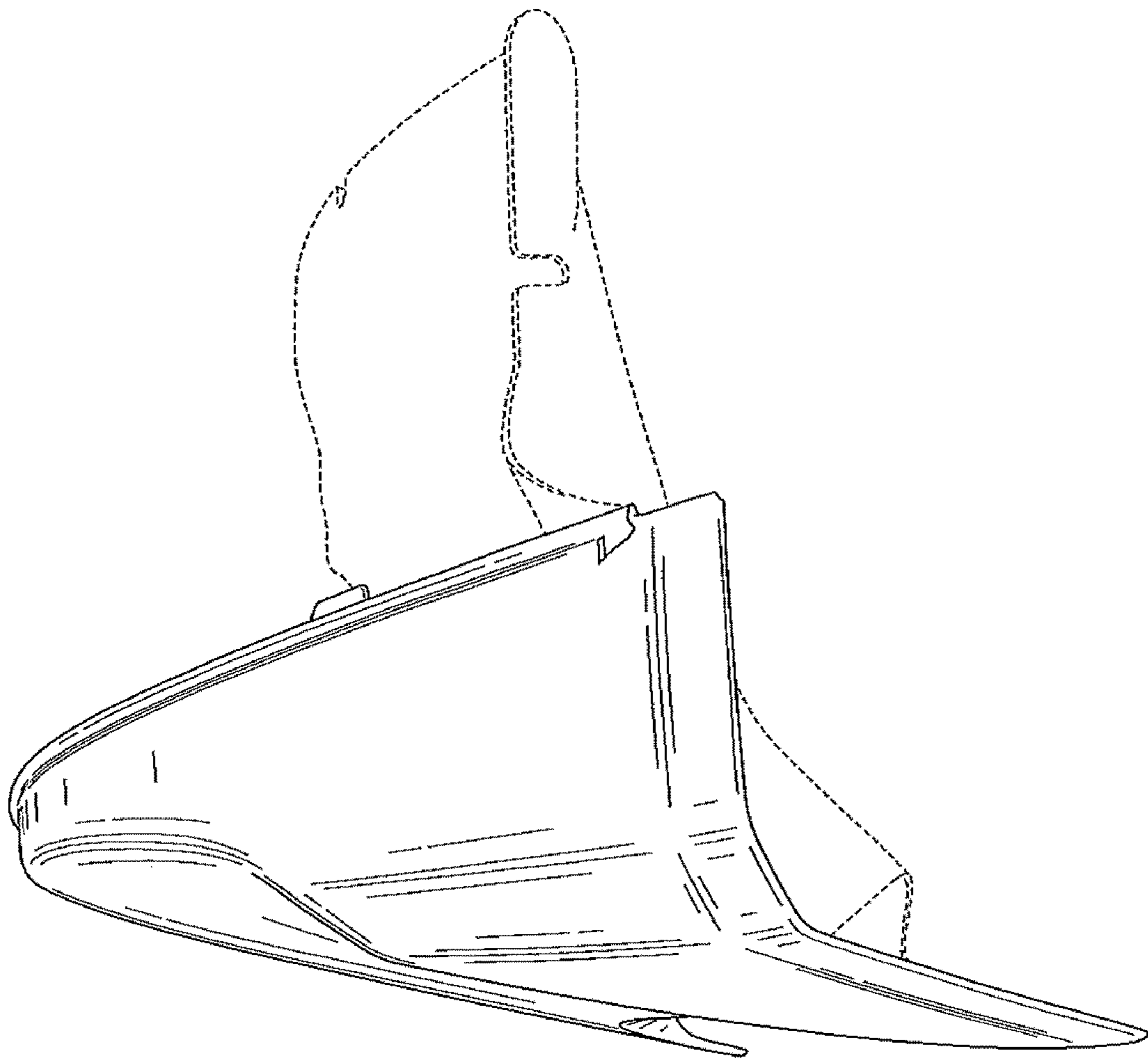

FIG. 2

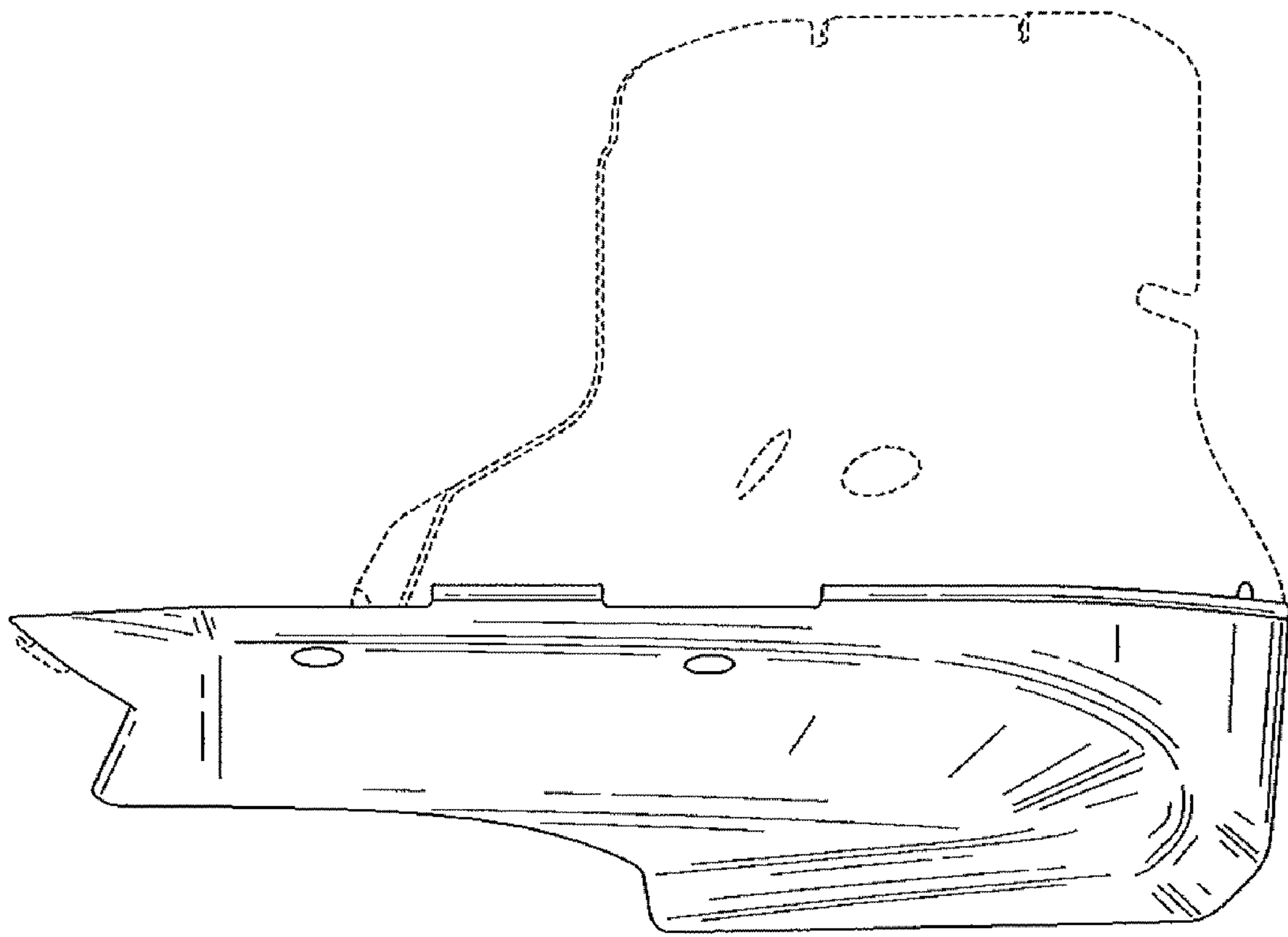

FIG. 3

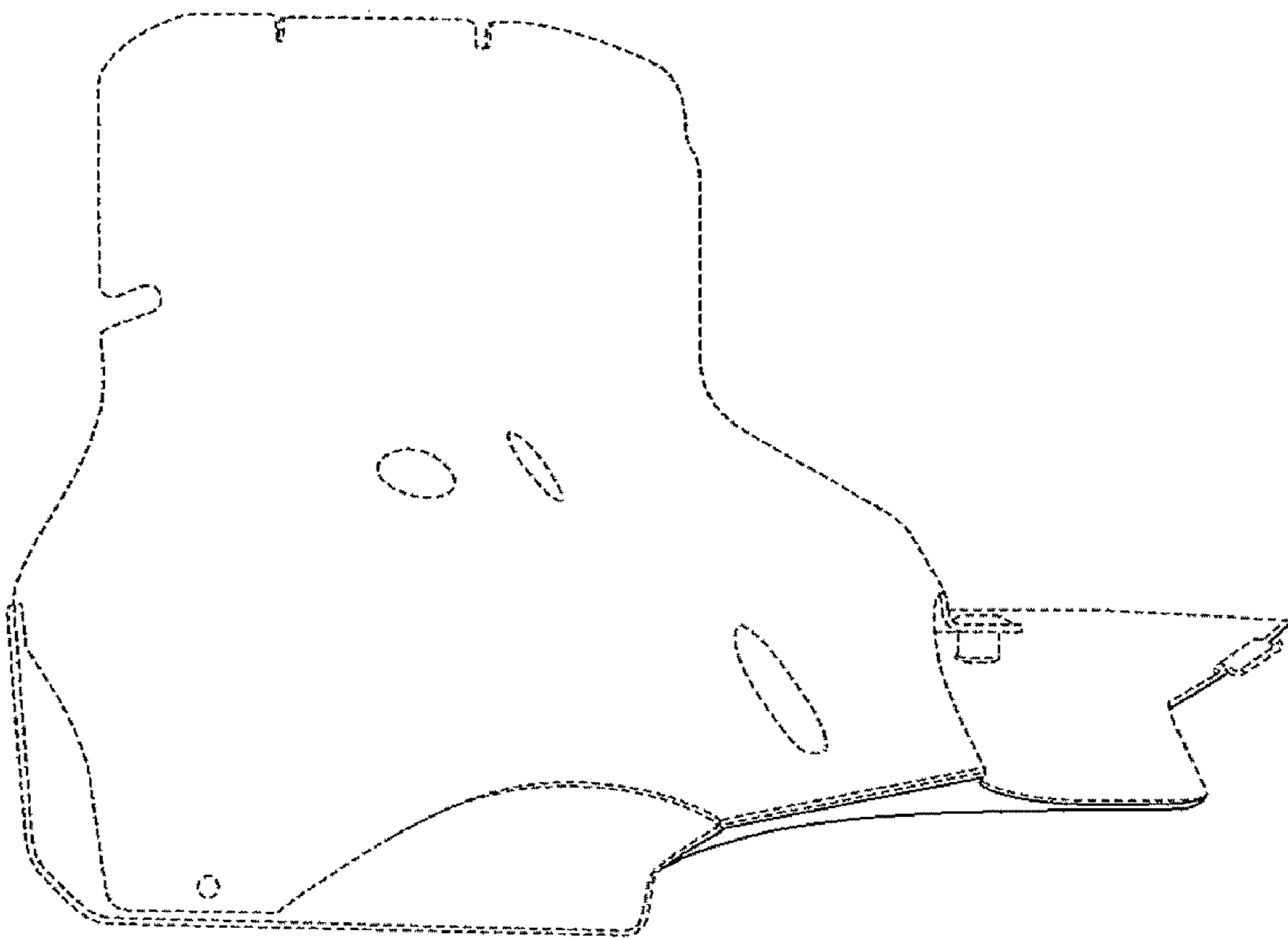

FIG. 4

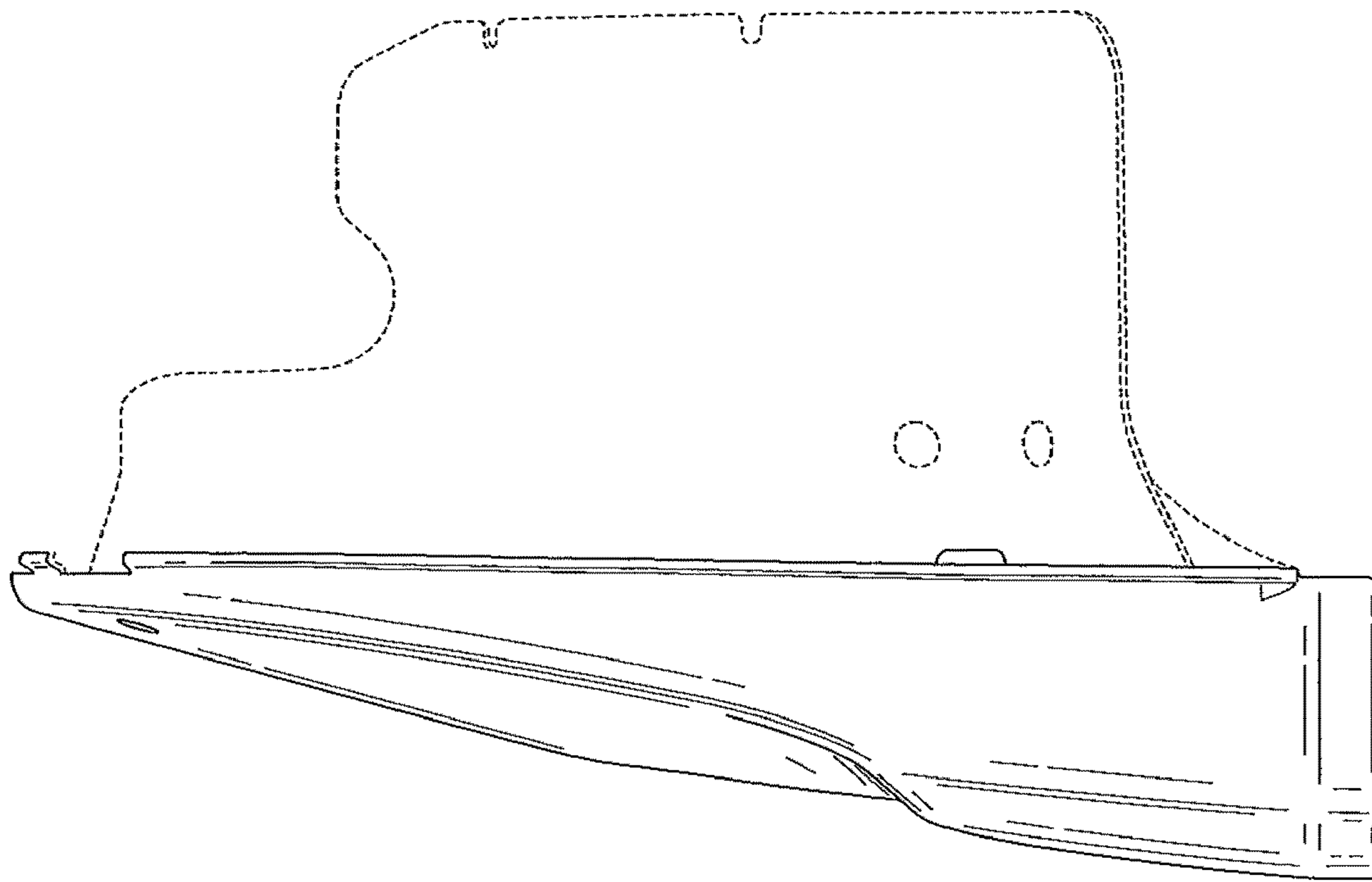

FIG. 5



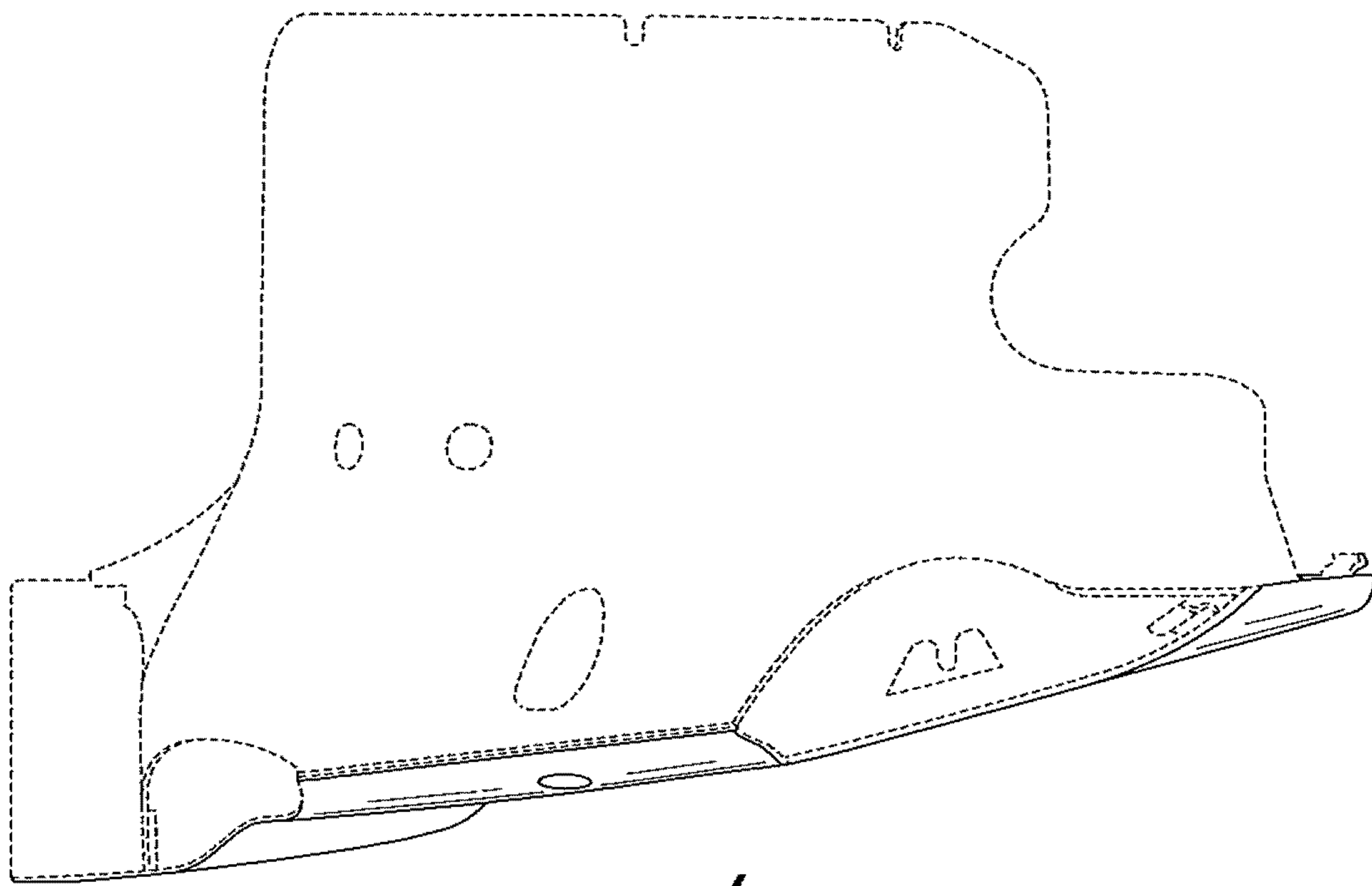
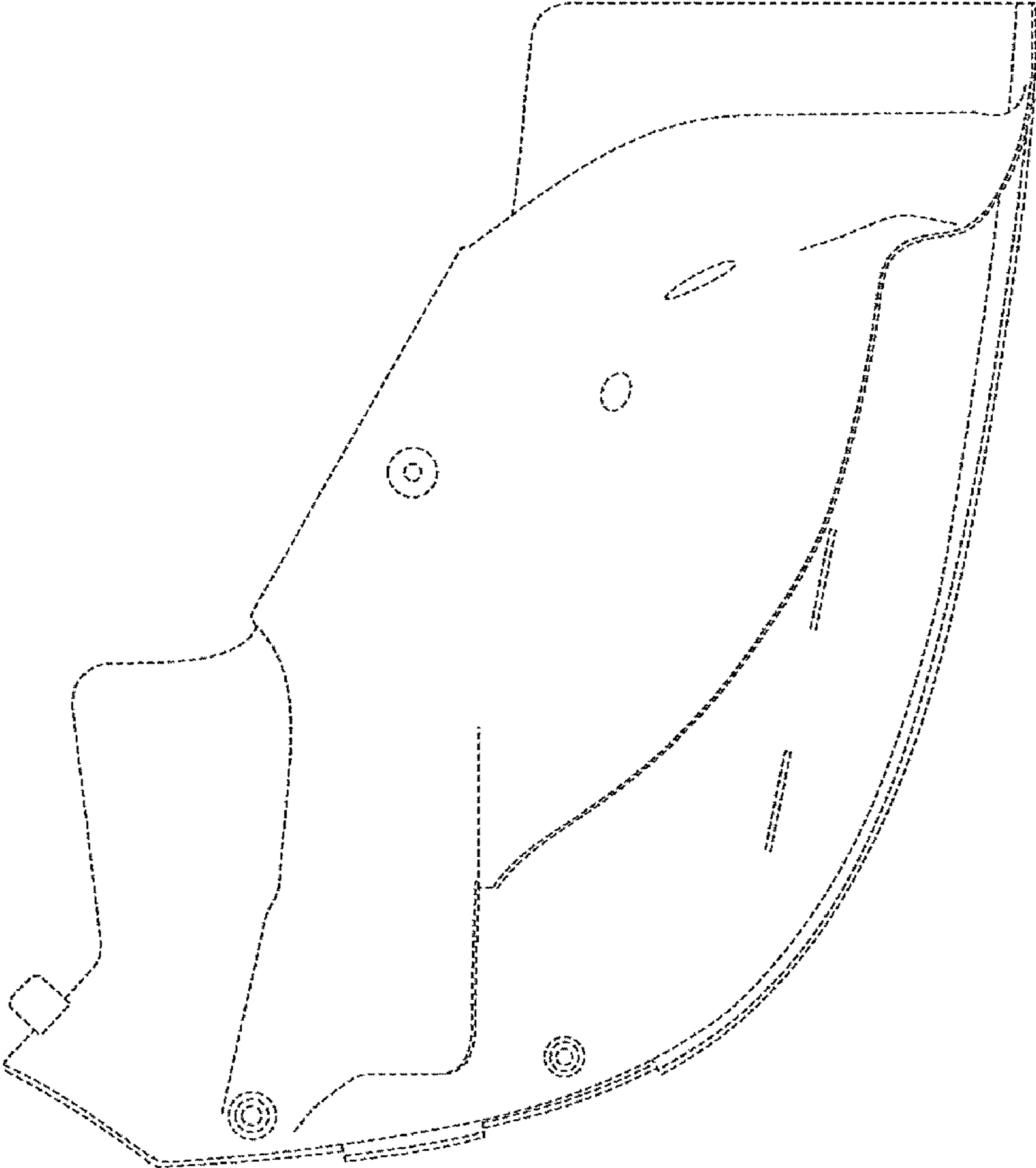

FIG. 6



**FIG. 7**



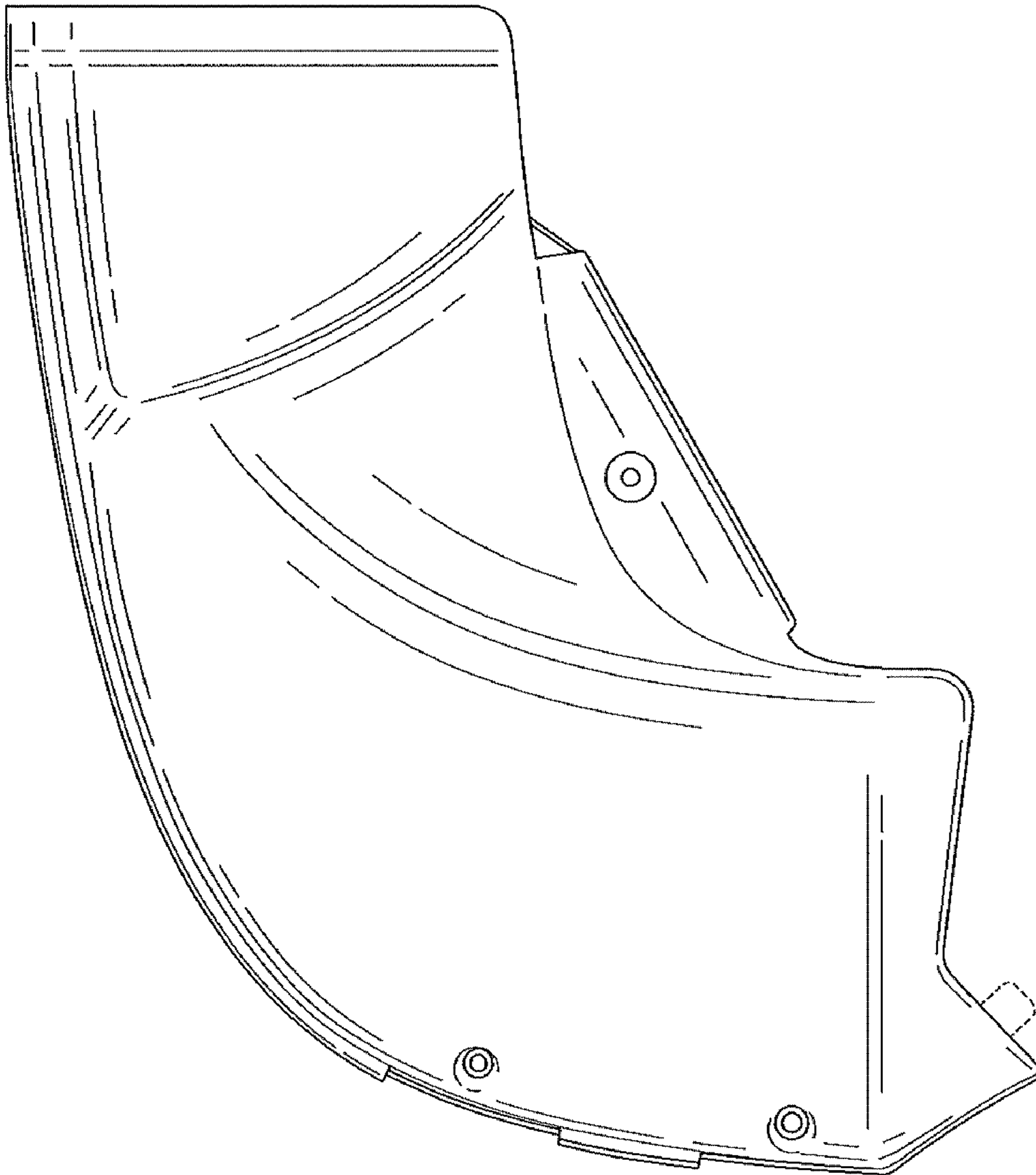

FIG. 8

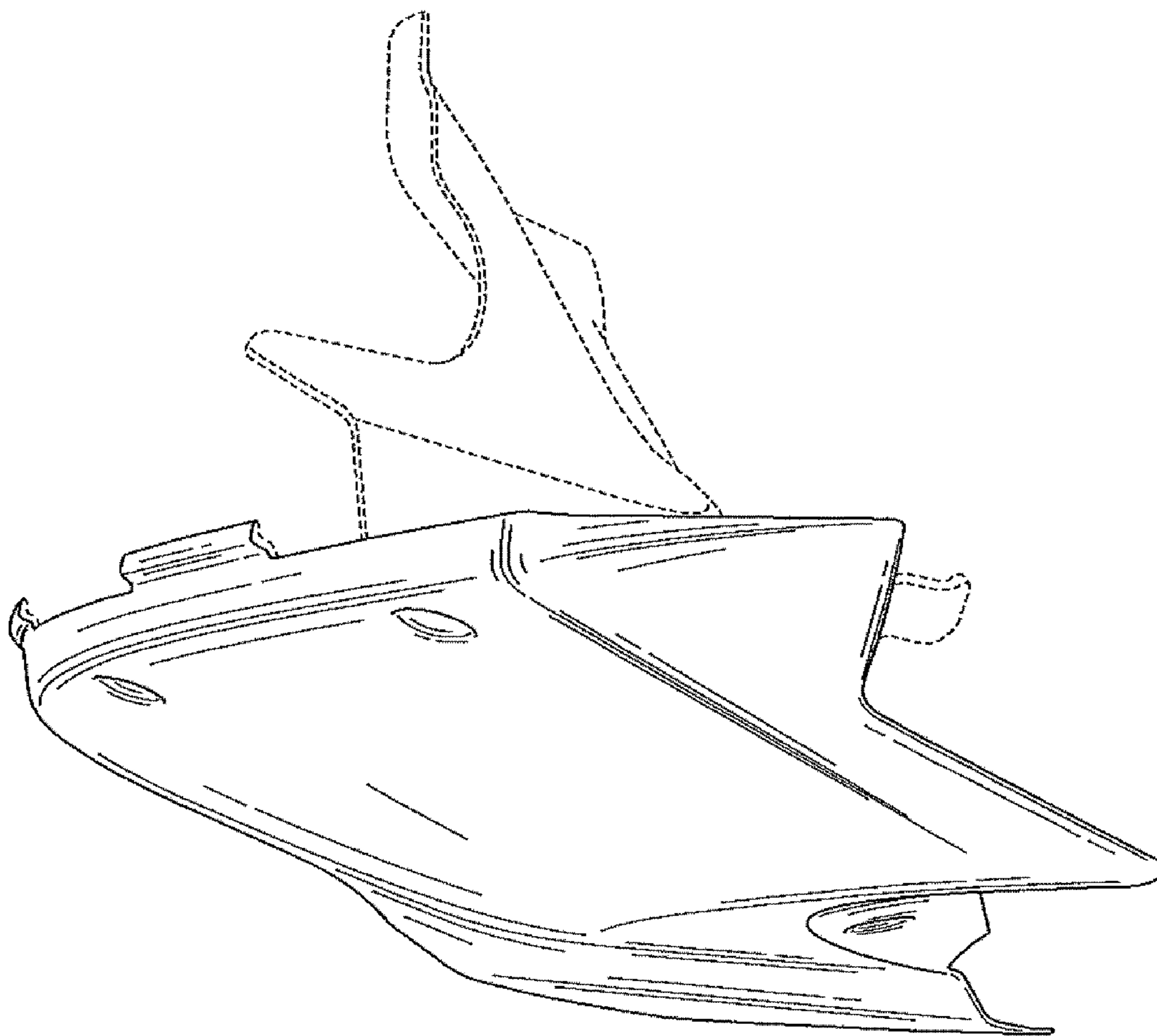

FIG. 9

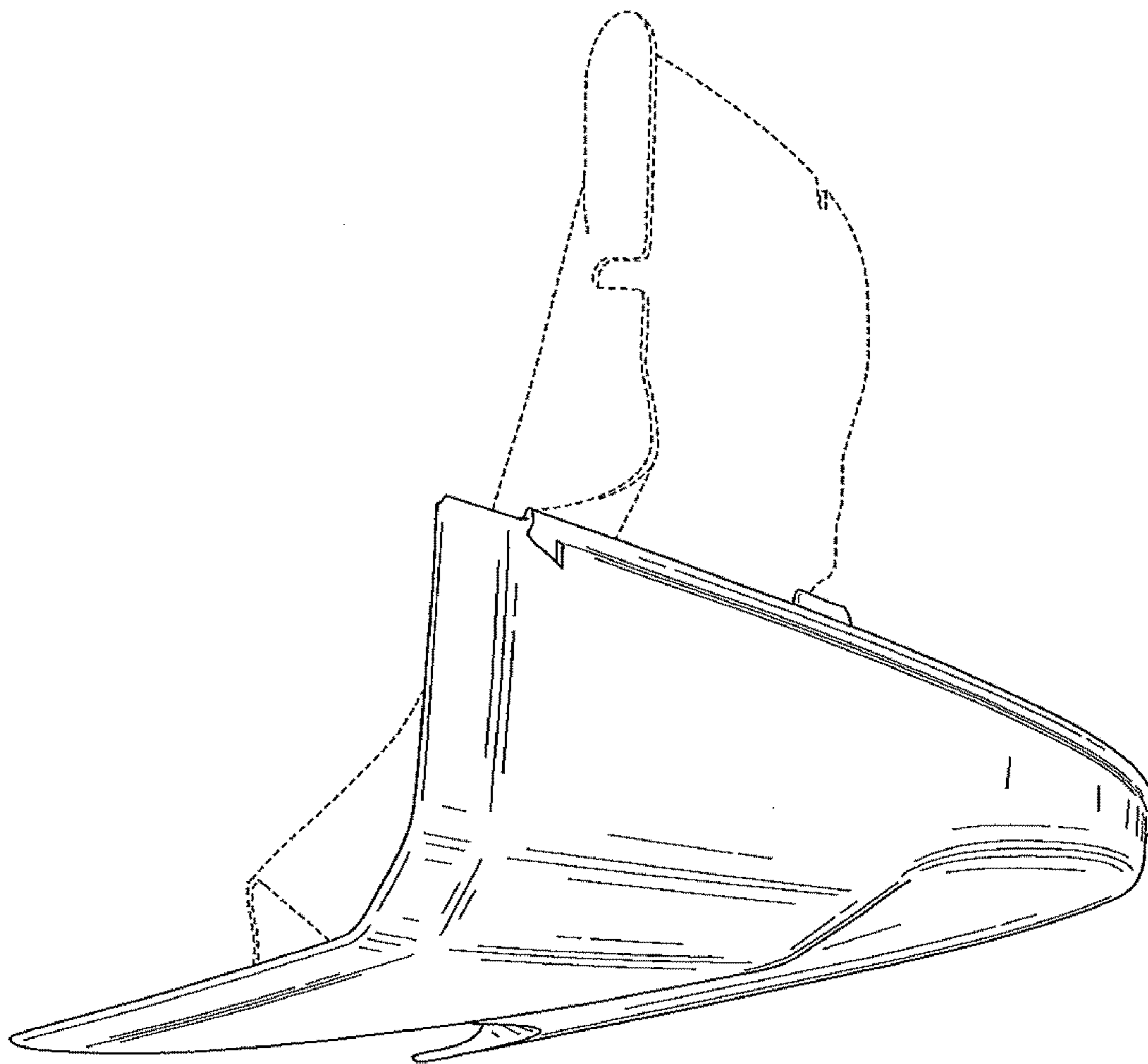

FIG. 10

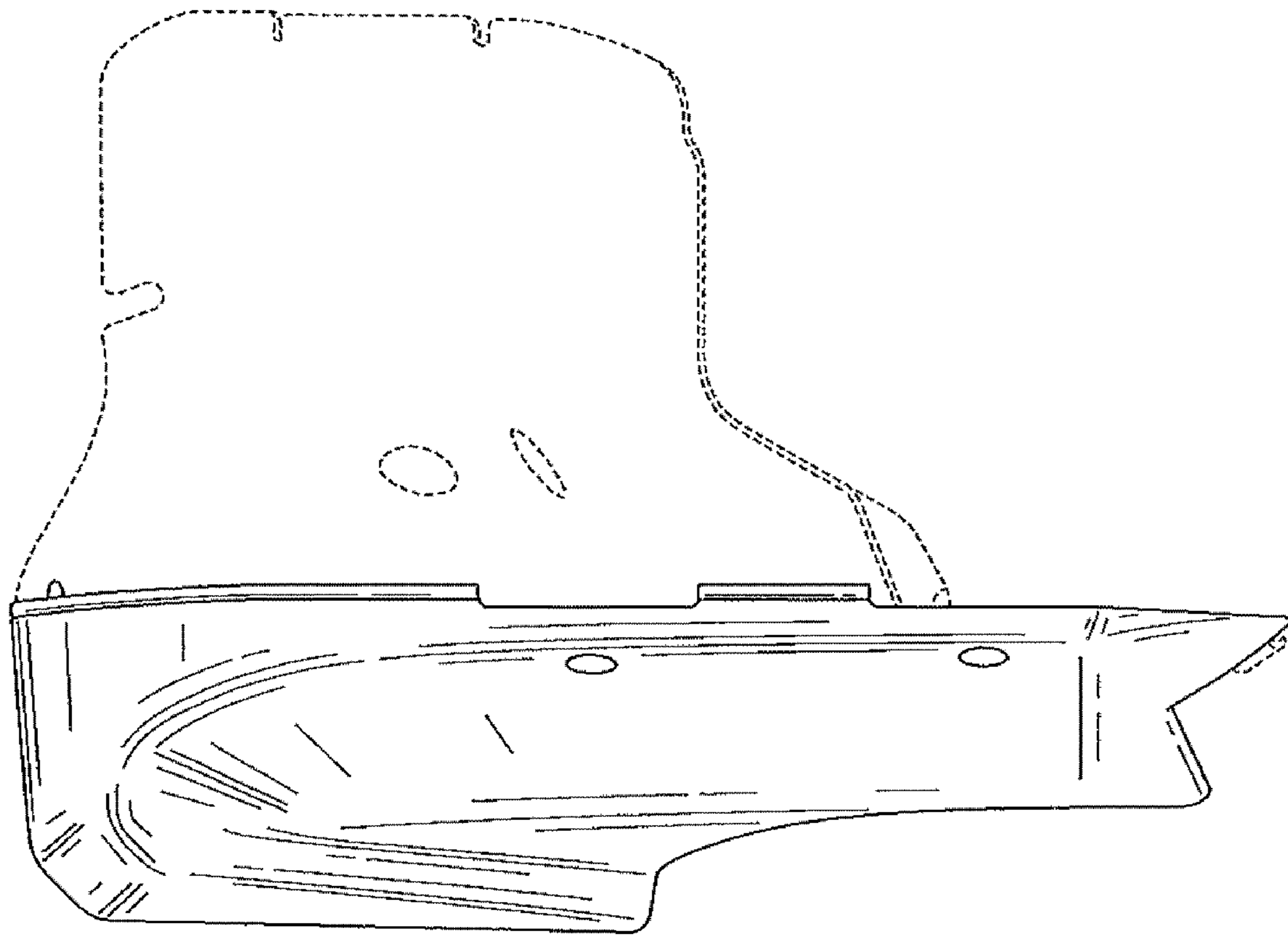

FIG. 11

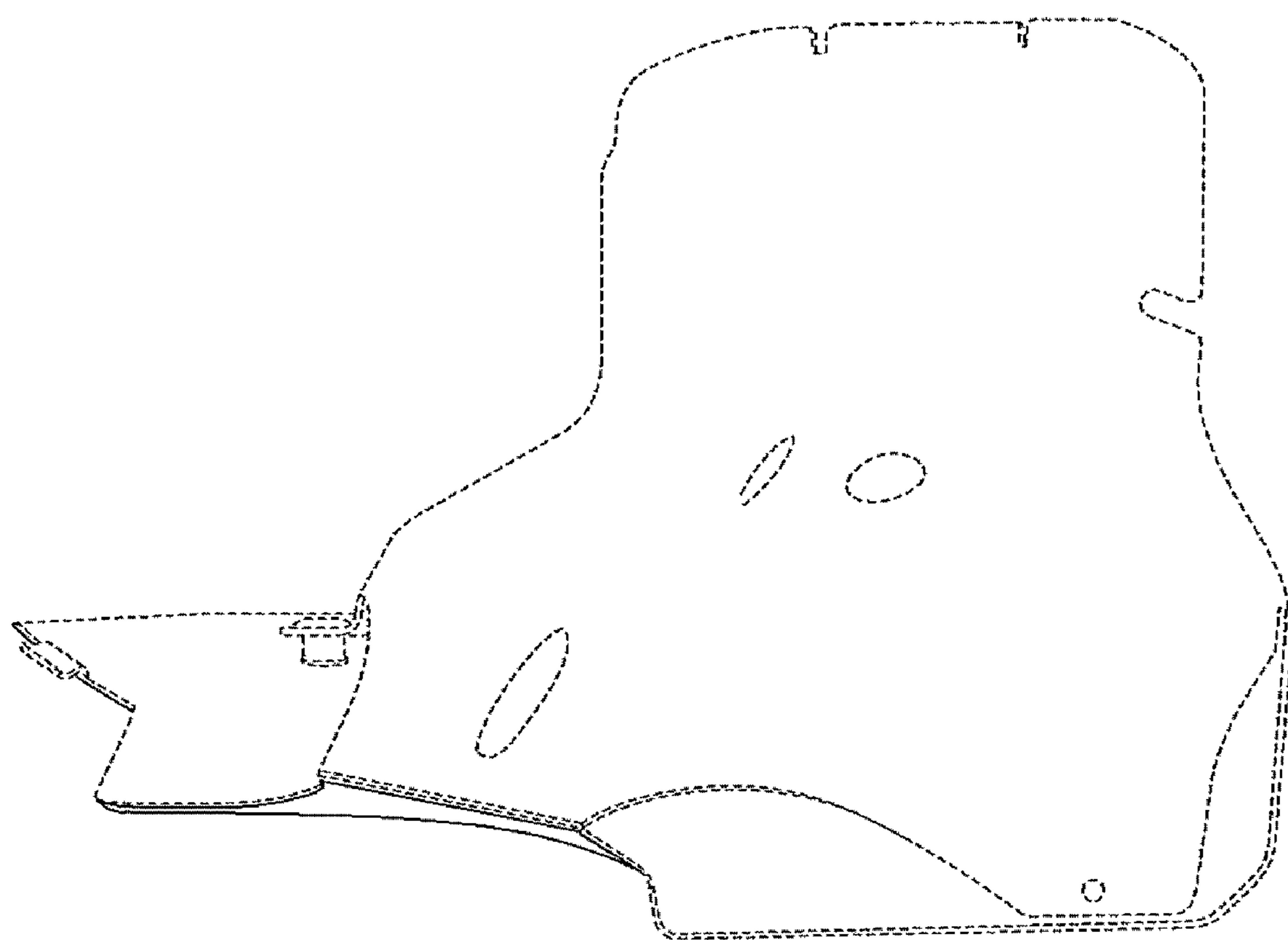

FIG. 12

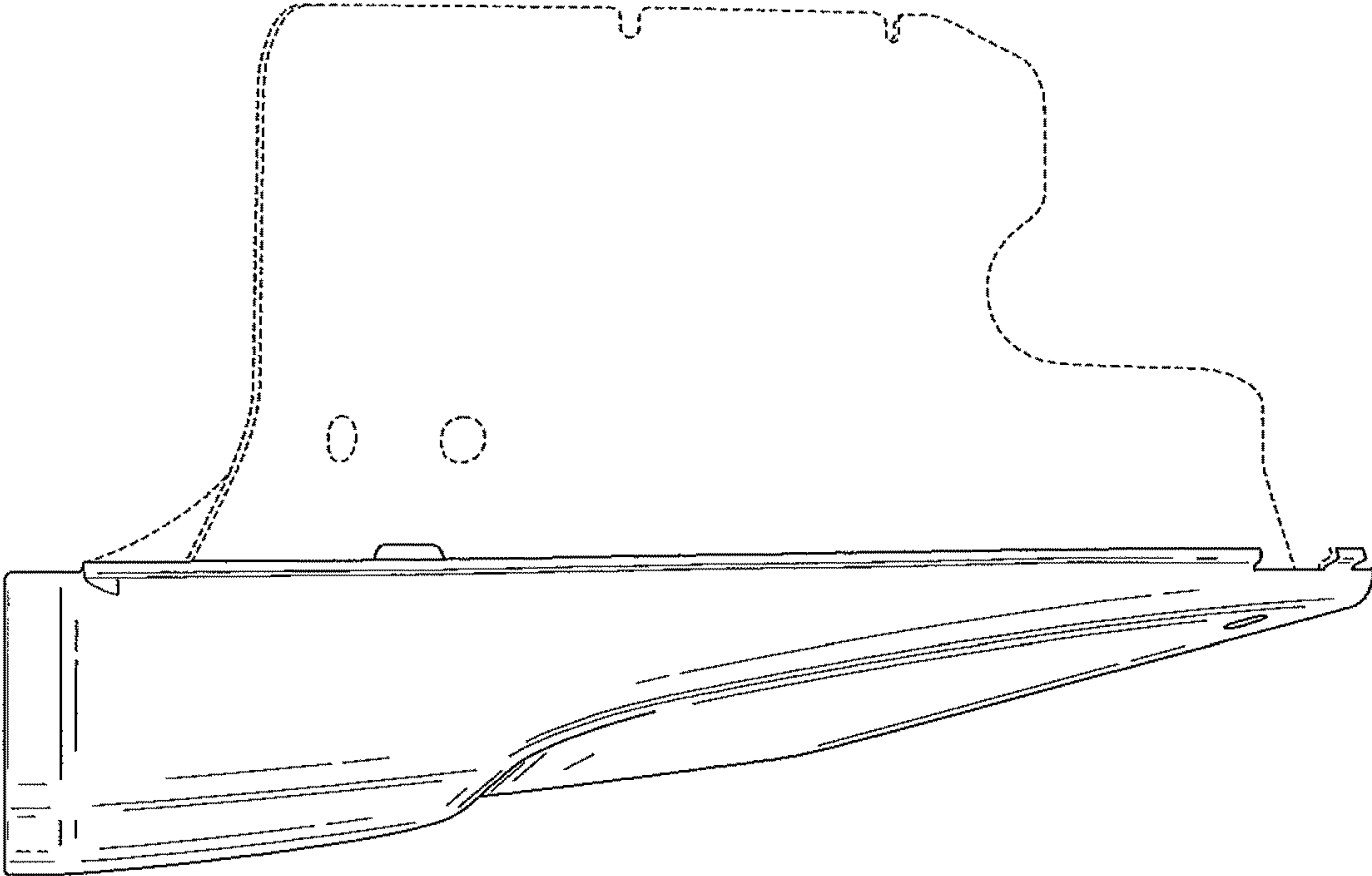

FIG. 13



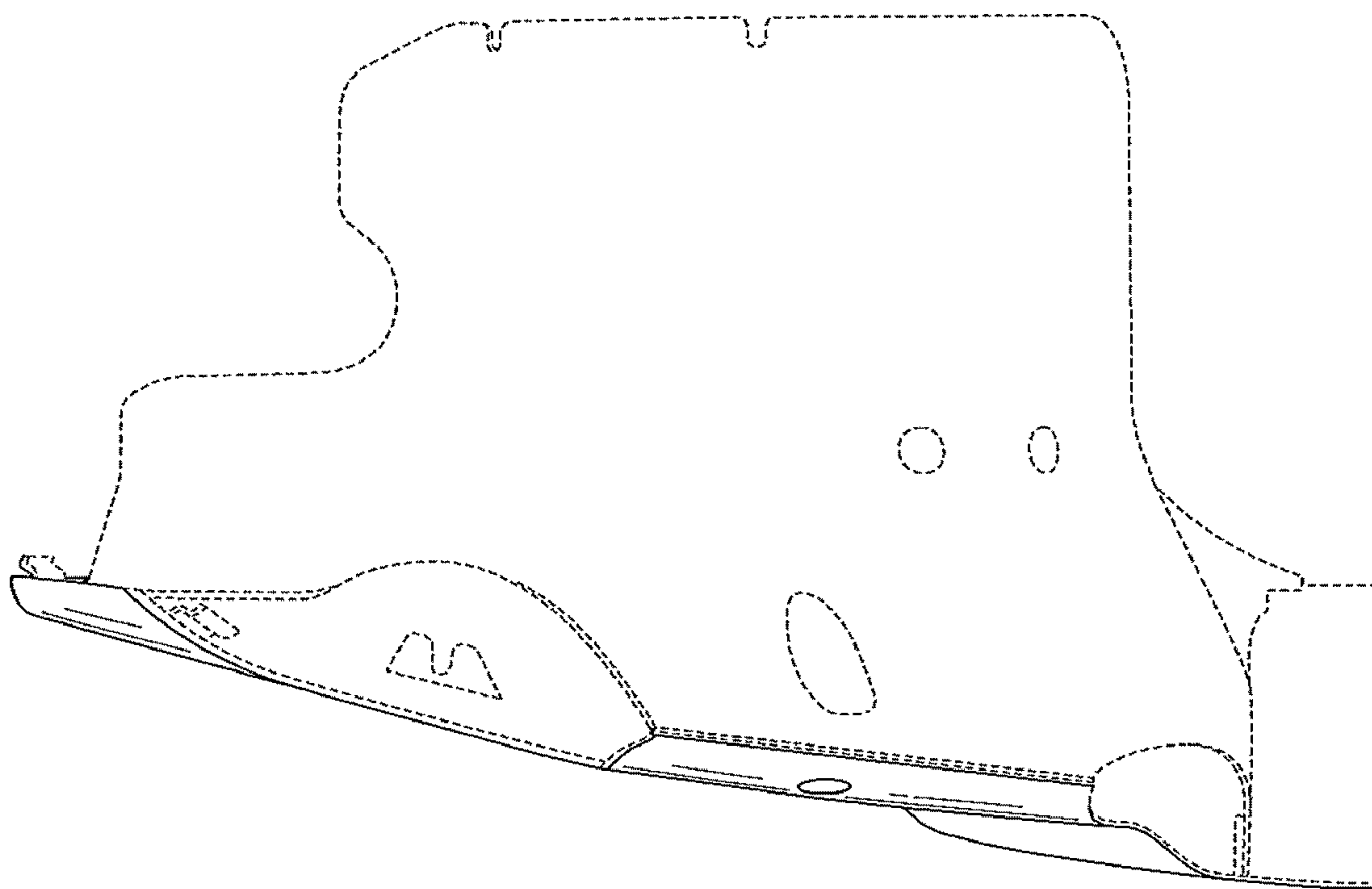

FIG. 14

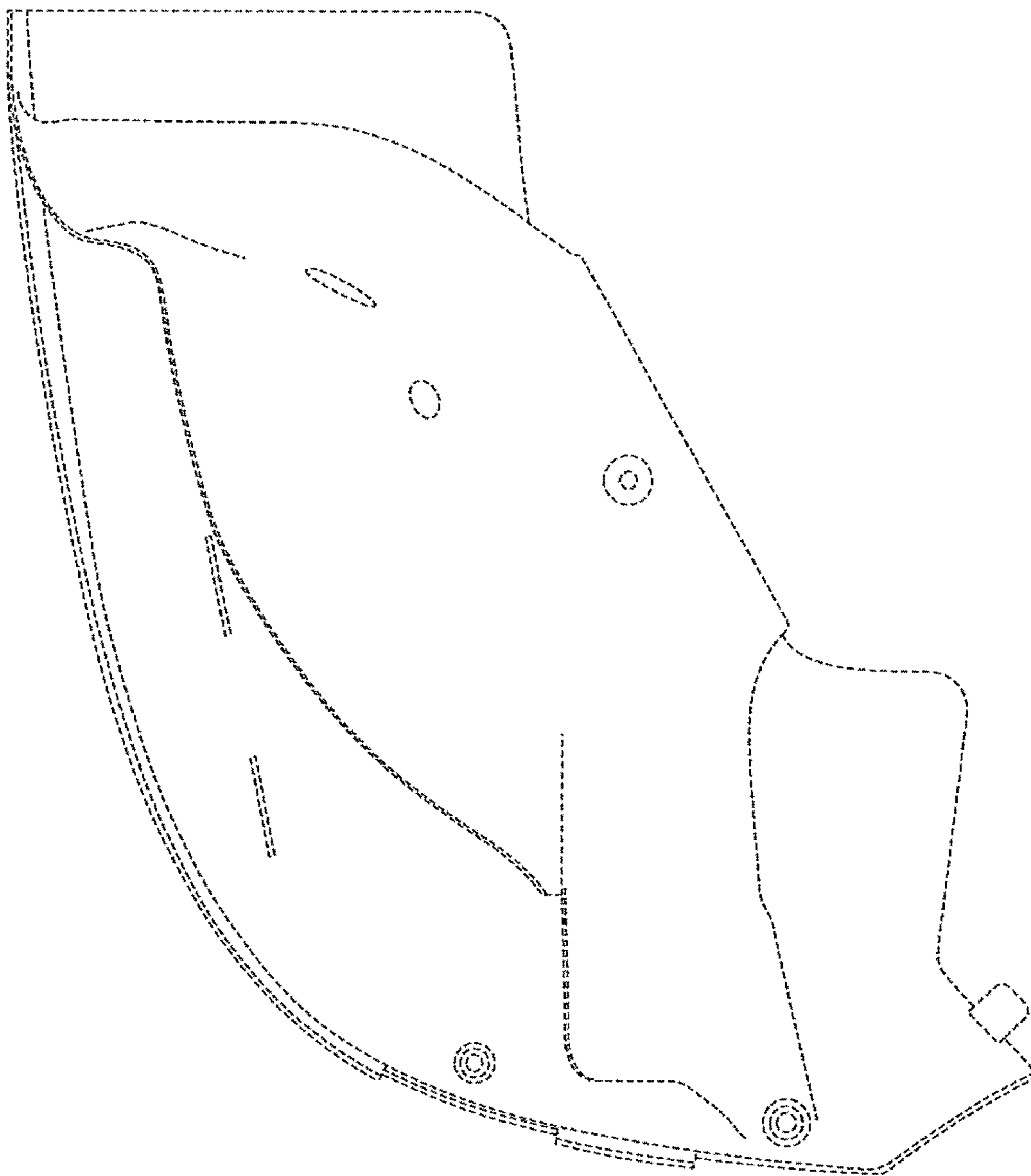

FIG. 15

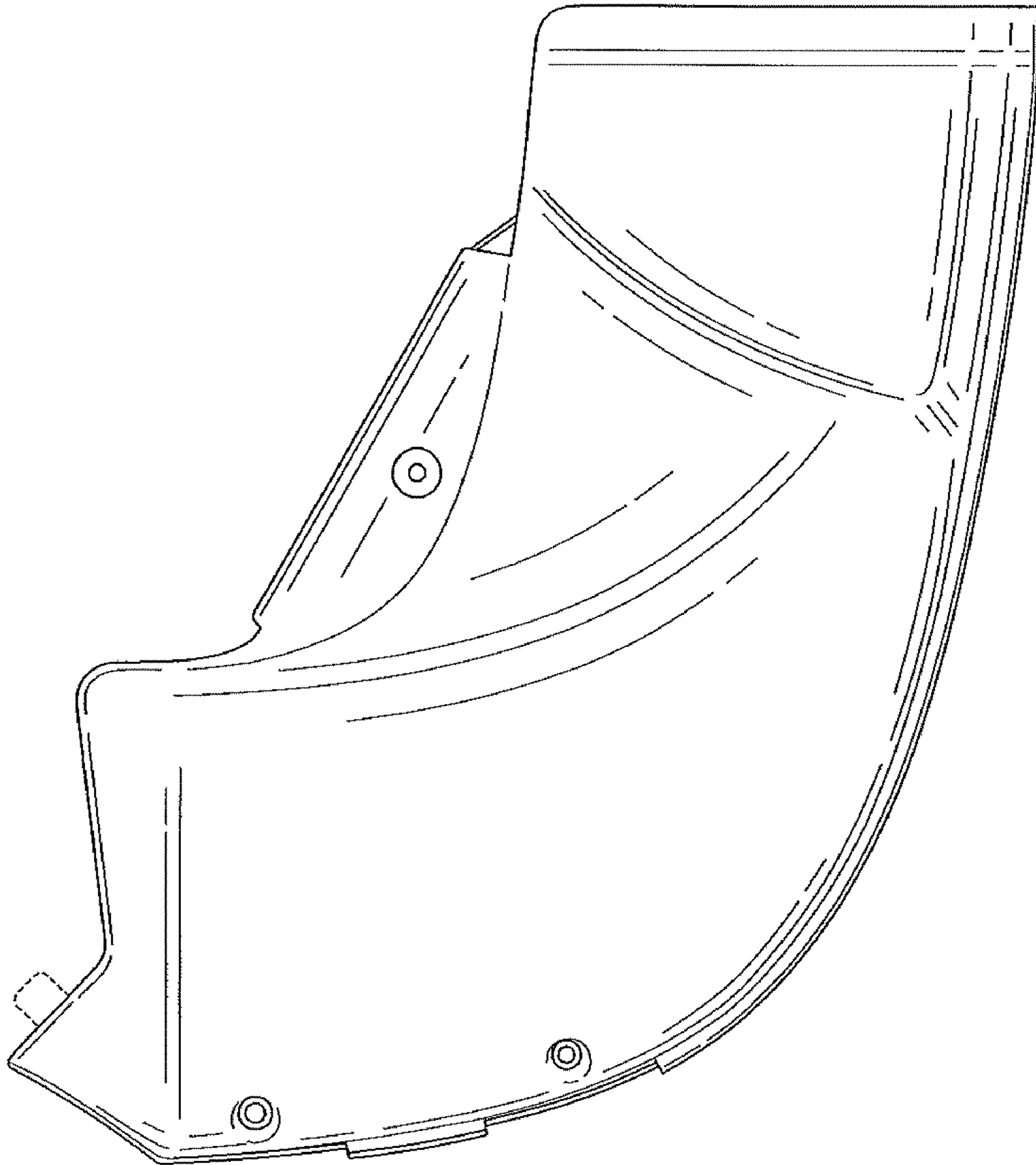

FIG. 16