



US00D650630S

(12) **United States Design Patent**
Warnock et al.

(10) **Patent No.:** **US D650,630 S**

(45) **Date of Patent:** **** Dec. 20, 2011**

(54) **HOUSING FOR AN AUTOMATIC FOOD DISPENSER**

(75) Inventors: **Laura Warnock**, Merrimack, NH (US);
Christopher M. Petersen, Milford, NH (US);
Stevenson Tom, Nashua, NH (US)

(73) Assignee: **Brookstone Purchasing, Inc.**,
Merrimack, NH (US)

(**) Term: **14 Years**

(21) Appl. No.: **29/384,312**

(22) Filed: **Jan. 28, 2011**

(51) **LOC (9) Cl.** **07-06**

(52) **U.S. Cl.** **D7/401.1**

(58) **Field of Classification Search** D7/401.1,
D7/589; D6/542-545; D20/1, 4, 7; 222/368,
222/288, 282, 251, 230, 185.1, 181.1, 173,
222/160, 367

See application file for complete search history.

(56) **References Cited**

U.S. PATENT DOCUMENTS

2,920,796	A *	1/1960	Field	222/185.1
D261,656	S *	11/1981	Svensson et al.	D7/589
D264,595	S	5/1982	Lyons		
4,569,463	A *	2/1986	Pellegrino	222/288
4,957,219	A *	9/1990	Robbins et al.	222/39
D392,843	S	3/1998	Mulvihill		
5,927,558	A *	7/1999	Bruce	222/185.1

D467,466	S *	12/2002	Apelboim et al.	D7/589
6,681,718	B1	1/2004	McIlarky		
D500,636	S *	1/2005	Levy et al.	D7/589
D507,936	S *	8/2005	Gold et al.	D7/589
6,964,355	B2 *	11/2005	Landau	222/185.1
D554,409	S *	11/2007	Scorgie	D6/542
D562,079	S *	2/2008	Ben Shlomo et al.	D7/589
2002/0134313	A1	9/2002	King et al.		
2004/0226962	A1	11/2004	Mazursky et al.		
2006/0249531	A1	11/2006	Litchfield		

* cited by examiner

Primary Examiner — Terry Wallace

(74) *Attorney, Agent, or Firm* — Grossman Tucker Perreault & Pfleger

(57) **CLAIM**

The ornamental design for a housing for an automatic food dispenser, as shown and described.

DESCRIPTION

FIG. 1 is a frontal perspective view of a housing for an automatic food dispenser.

FIG. 2 is a front elevation view thereof.

FIG. 3 is a rear elevation view thereof.

FIG. 4 is a right side elevation view thereof.

FIG. 5 is a left side elevation view thereof.

FIG. 6 is a top plan view thereof; and,

FIG. 7 is a bottom plan view thereof.

The broken lines shown on the drawings are for illustrative purposes only and form no part of the claimed design.

1 Claim, 7 Drawing Sheets

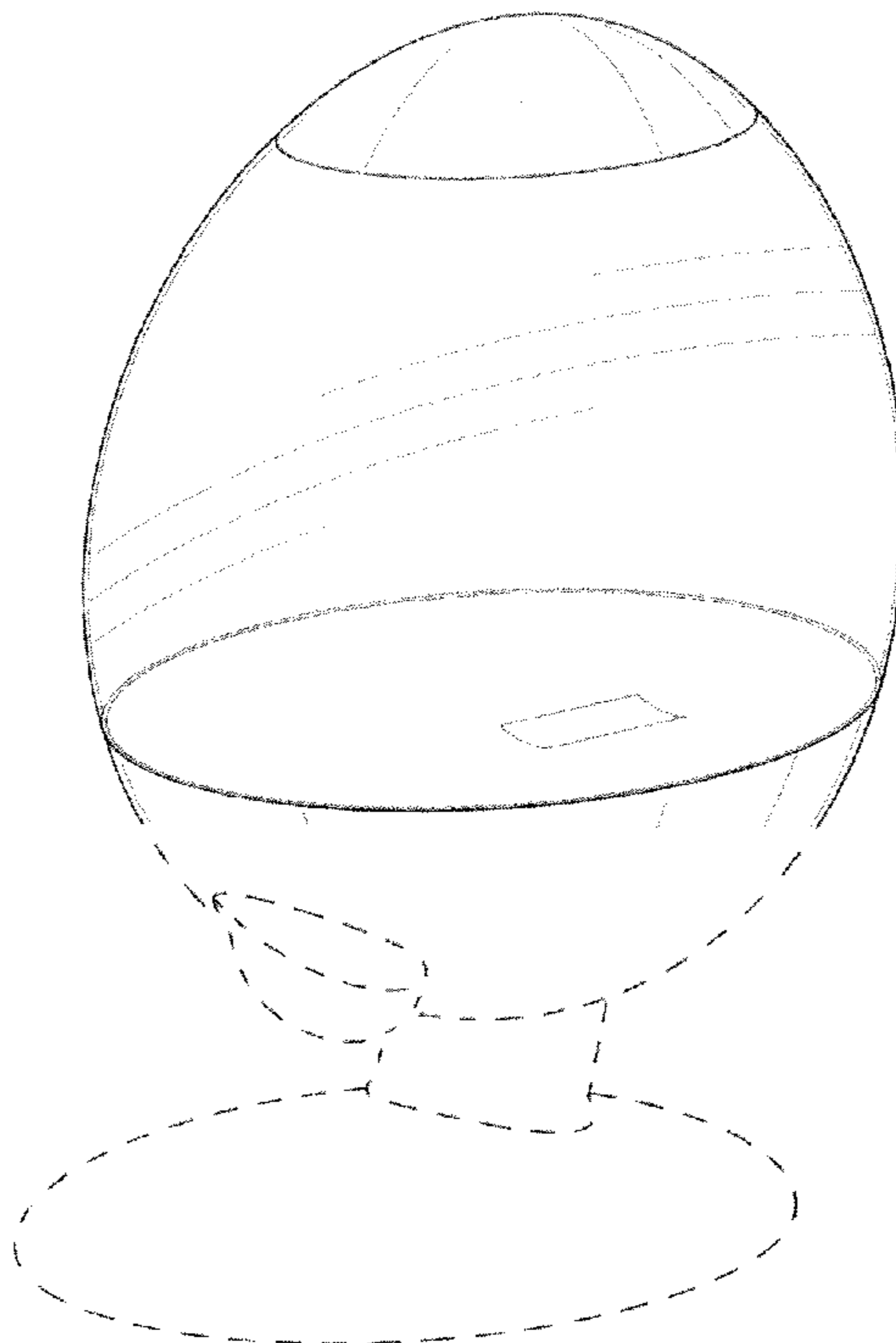

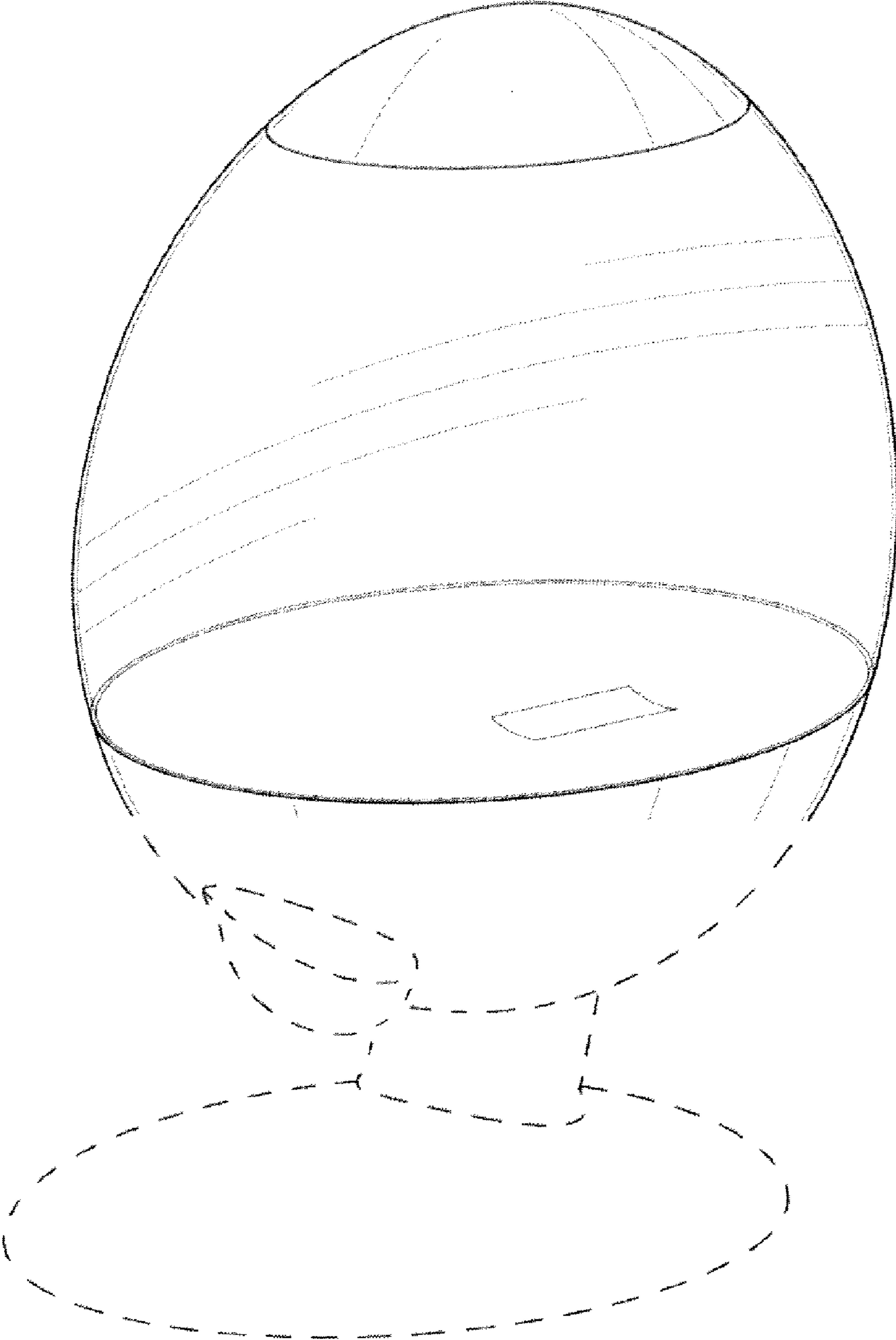

Figure 1

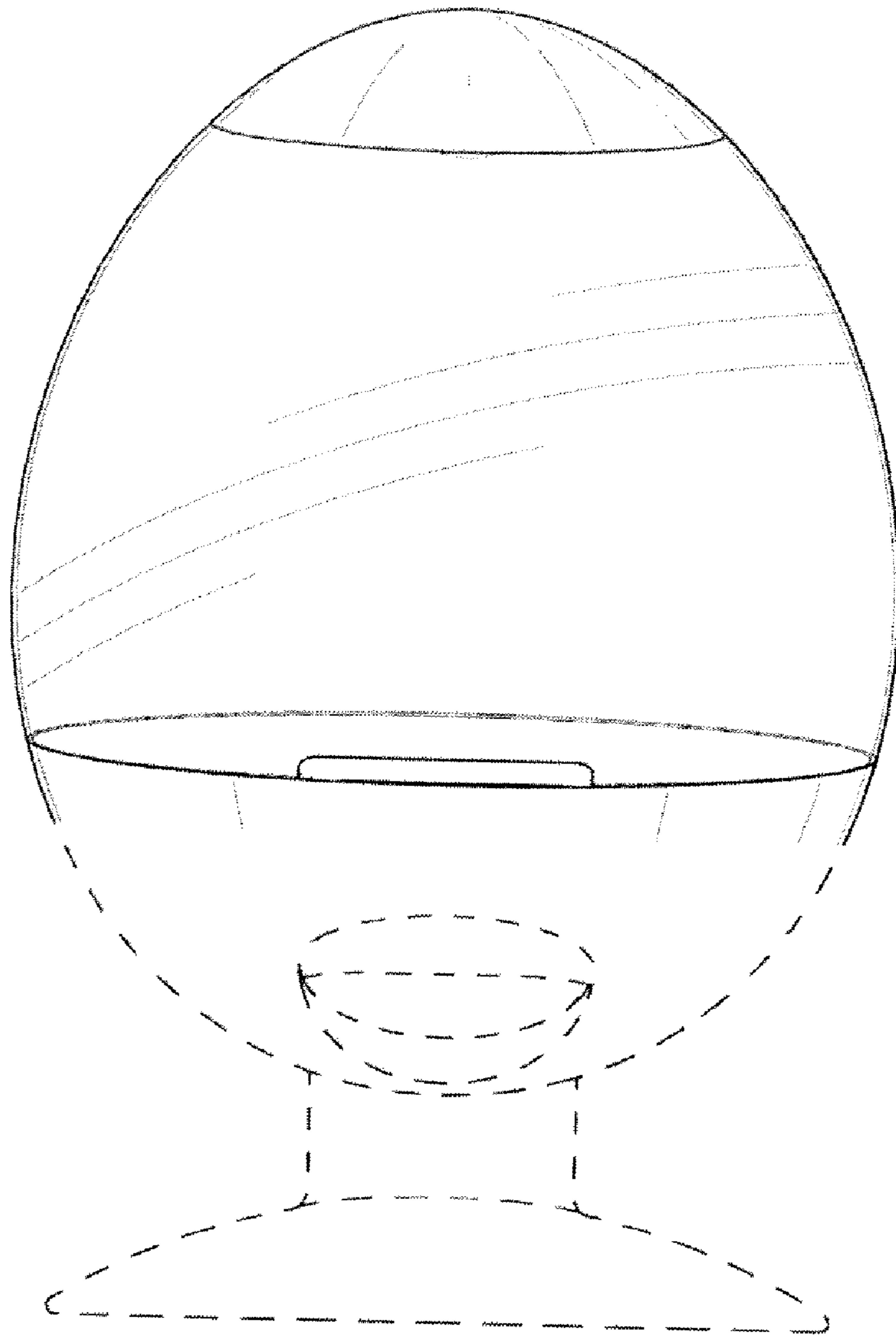

Figure 2

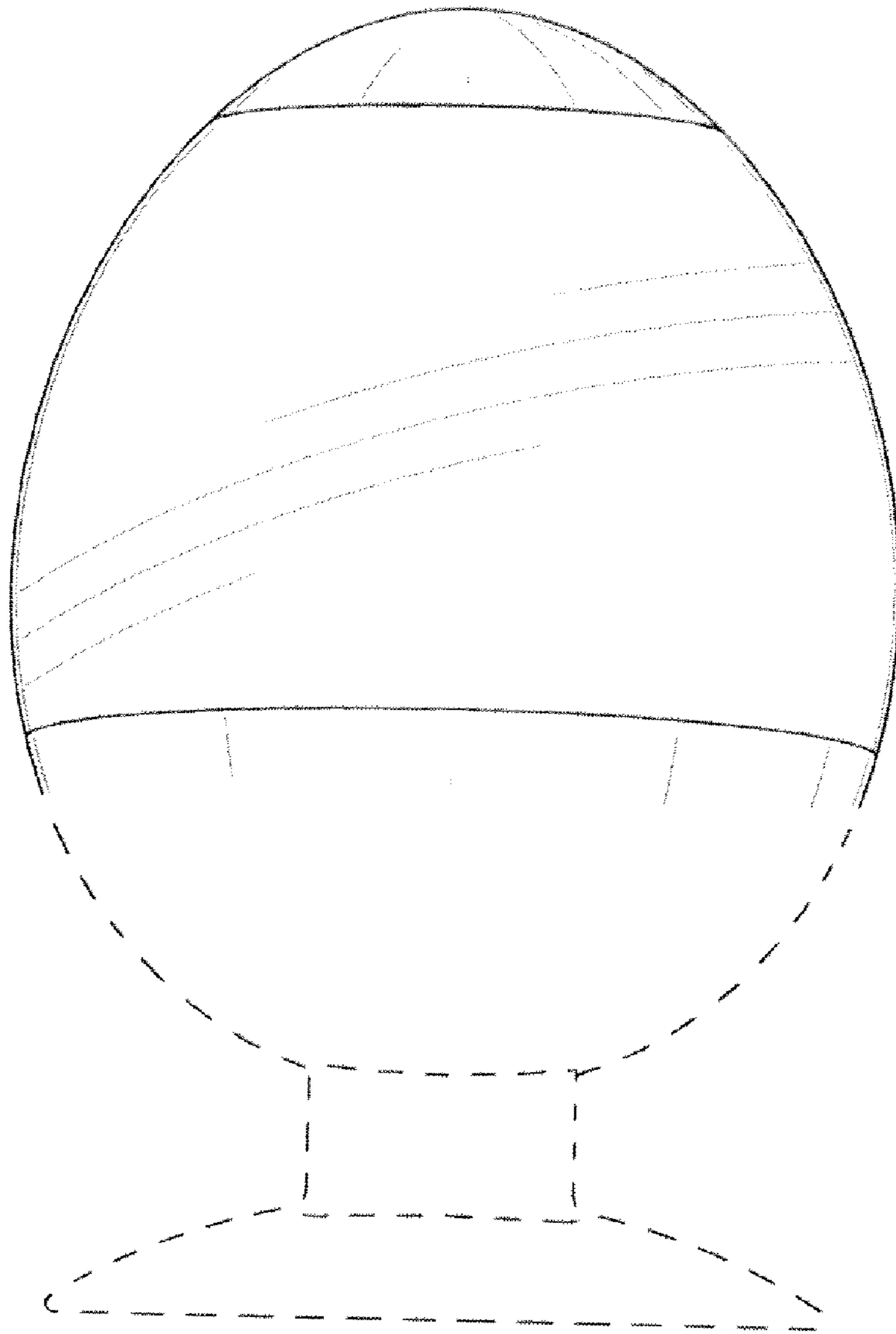

Figure 3

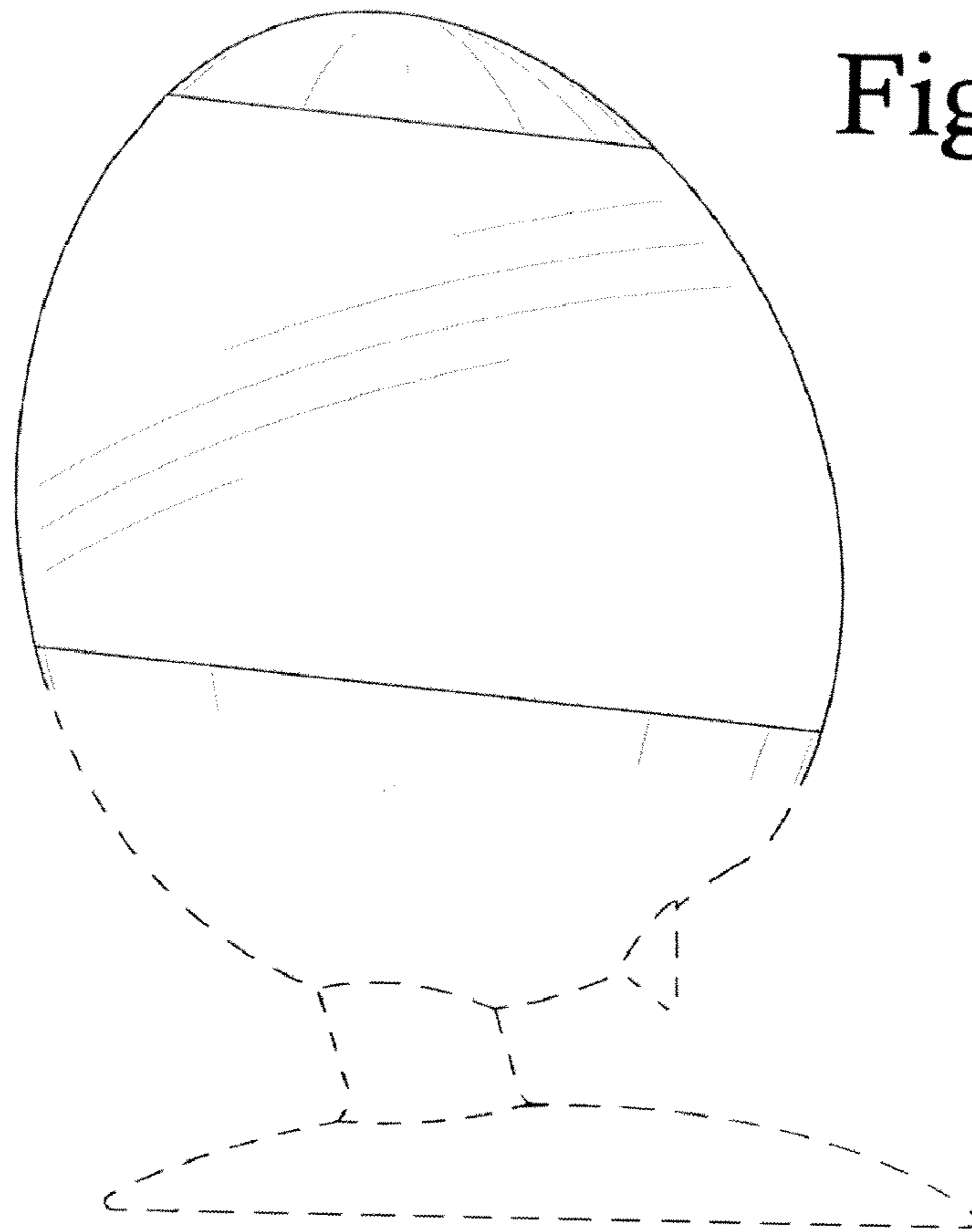
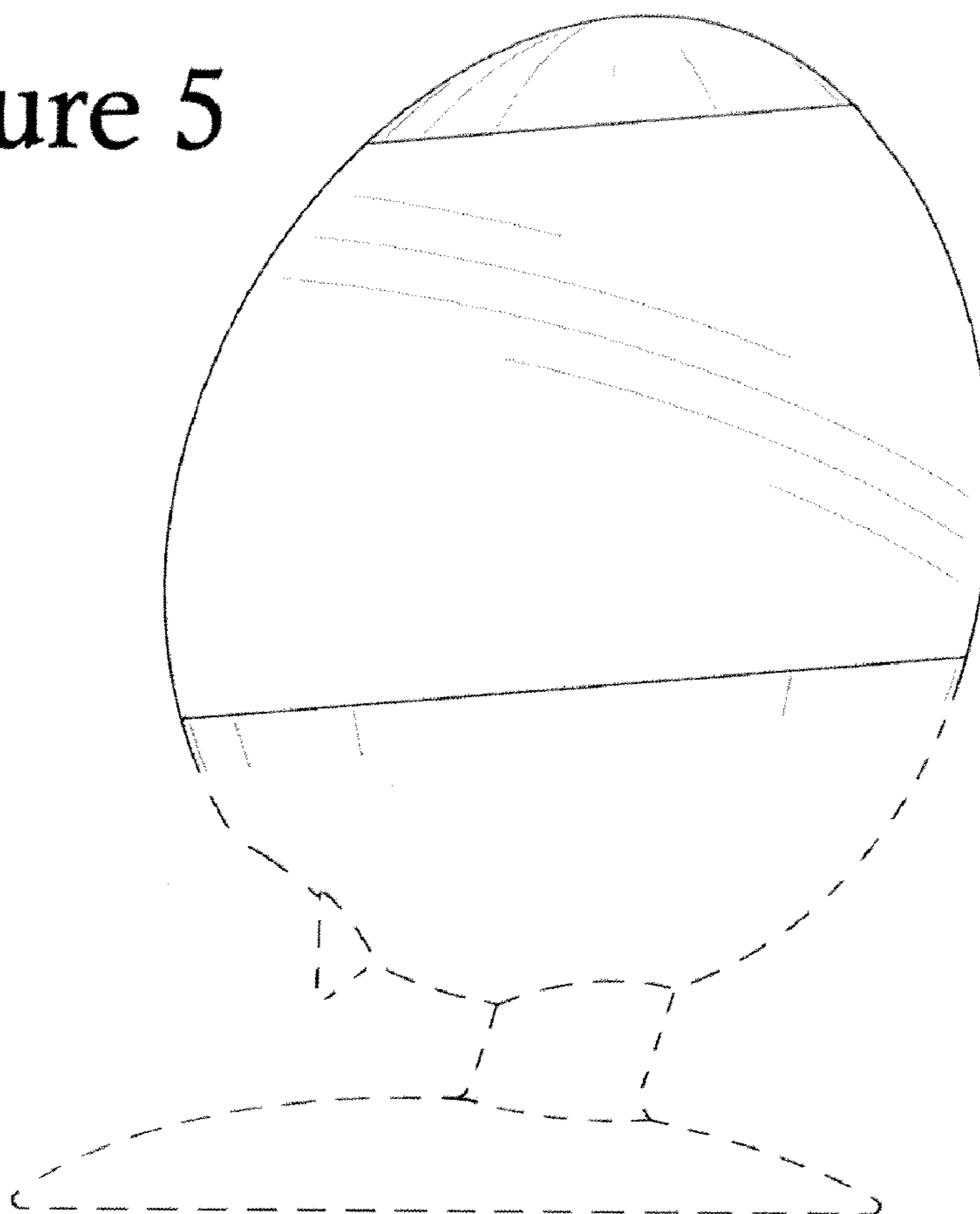

Figure 4

Figure 5



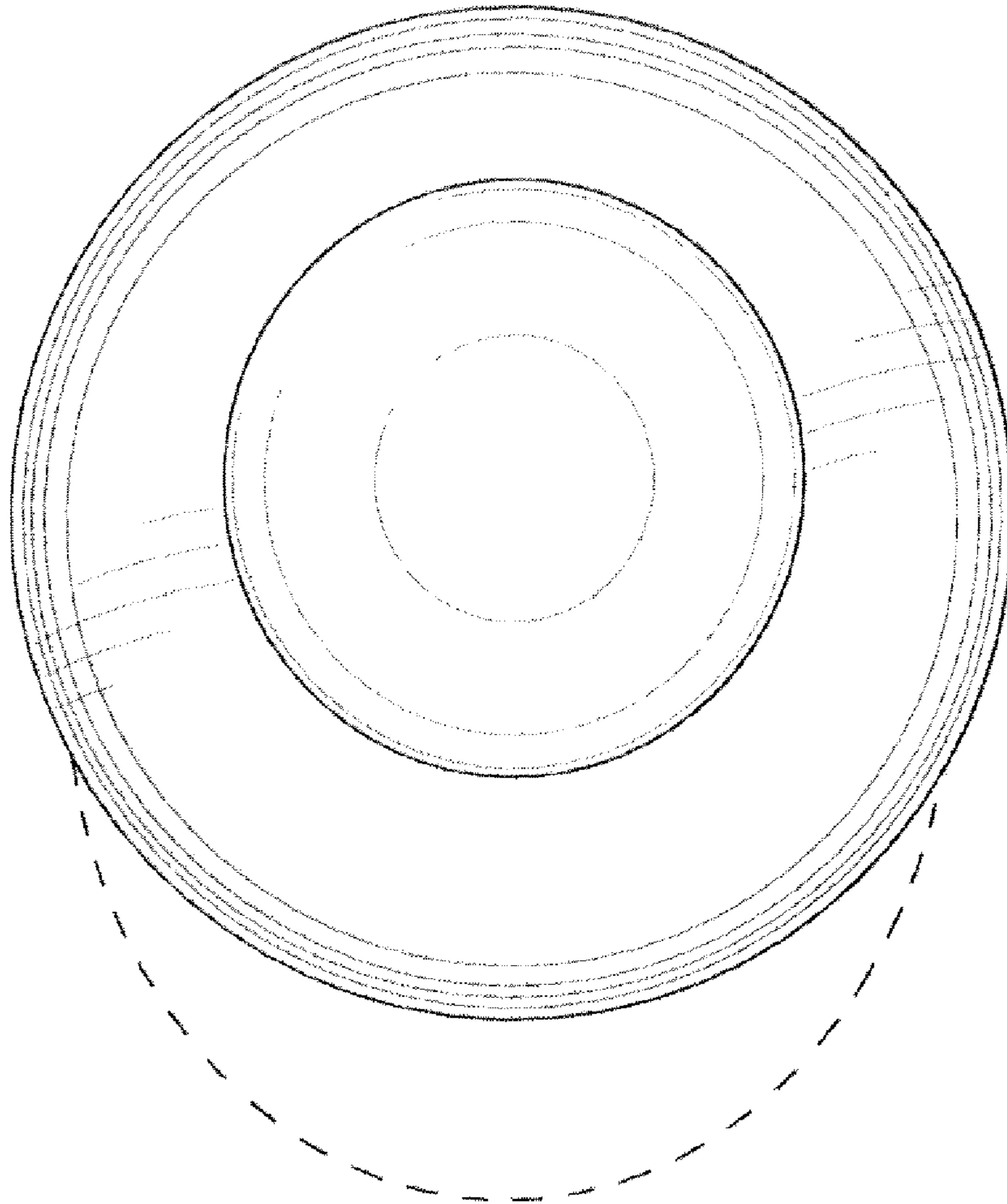

Figure 6

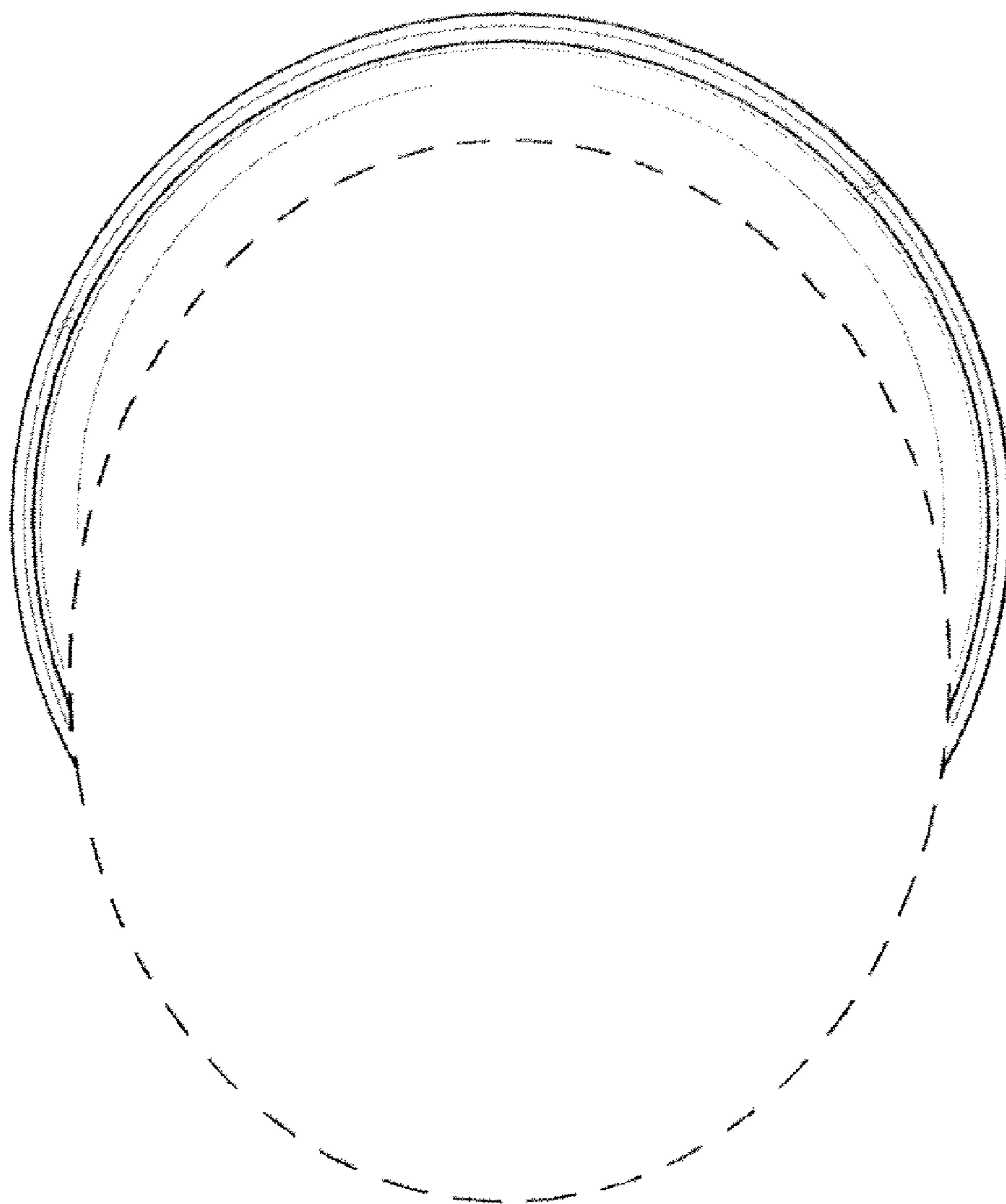

Figure 7