



US00D650628S

(12) **United States Design Patent**
Palotto

(10) **Patent No.:** **US D650,628 S**

(45) **Date of Patent:** **** Dec. 20, 2011**

(54) **COVER FOR A POT**

(75) Inventor: **Simone Palotto**, Etterbeek (BE)

(73) Assignee: **Dart Industries Inc.**, Orlando, FL (US)

(**) Term: **14 Years**

(21) Appl. No.: **29/372,101**

(22) Filed: **Oct. 15, 2010**

(51) **LOC (9) Cl.** **07-02**

(52) **U.S. Cl.** **D7/391; D7/354**

(58) **Field of Classification Search** D7/318,
D7/323, 354-363, 391-396, 402, 538, 542-543,
D7/610; D9/434-435, 443; 16/110.1, 407,
16/430-431, 441, 443; 219/620-622, 725,
219/729-730, 734; 220/365-367.1, 573.1-573.5,
220/752-758, 767-771, 832, 912

See application file for complete search history.

(56) **References Cited**

U.S. PATENT DOCUMENTS

D148,442 S *	1/1948	Richeson et al.	D7/358
D192,257 S *	2/1962	Epstein	D7/393
D217,179 S *	4/1970	Rakocy	D7/318
3,850,331 A *	11/1974	Oxel	220/832
D342,863 S *	1/1994	Patrick	D7/361
D401,468 S *	11/1998	Knoll et al.	D7/323
D445,631 S *	7/2001	Elorza	D7/358
D448,965 S *	10/2001	Jang-Won	D7/360
D495,922 S	9/2004	Settele		
D521,312 S	5/2006	Pukall et al.		
D521,313 S	5/2006	Pukall et al.		
D573,834 S *	7/2008	Iwasaki et al.	D7/318
D582,205 S	12/2008	Gerlach		

D588,397 S *	3/2009	Naef et al.	D7/354
D619,892 S *	7/2010	Welk et al.	D9/443
2006/0174776 A1	8/2006	Fissler		

* cited by examiner

Primary Examiner — Ricky Pham

(74) *Attorney, Agent, or Firm* — John A. Doninger

(57) **CLAIM**

The ornamental design for a cover for a pot, as shown and described.

DESCRIPTION

FIG. 1 is a top, side and front perspective view of a first embodiment of a cover for a pot showing my new design; FIG. 2 is a front elevation view, the rear elevation being a mirror image thereof; FIG. 3 is a right side elevation view thereof; FIG. 4 is a left side elevation view thereof; FIG. 5 is a top plan view thereof; FIG. 6 is a bottom plan view thereof; FIG. 7 is a cross-sectional view along line 7-7 of FIG. 5; FIG. 8 is a cross-sectional view along line 8-8 of FIG. 5; FIG. 9 is a top, side and front perspective view of a second embodiment of a cover for a pot showing my new design; FIG. 10 is a front elevation view, the rear elevation being a mirror image thereof; FIG. 11 is a right side elevation view thereof; FIG. 12 is a left side elevation view thereof; FIG. 13 is a top plan view thereof; FIG. 14 is a bottom plan view thereof; FIG. 15 is a cross-sectional view along line 15-15 of FIG. 13; and, FIG. 16 is a cross-sectional view along line 16-16 of FIG. 13.

1 Claim, 8 Drawing Sheets

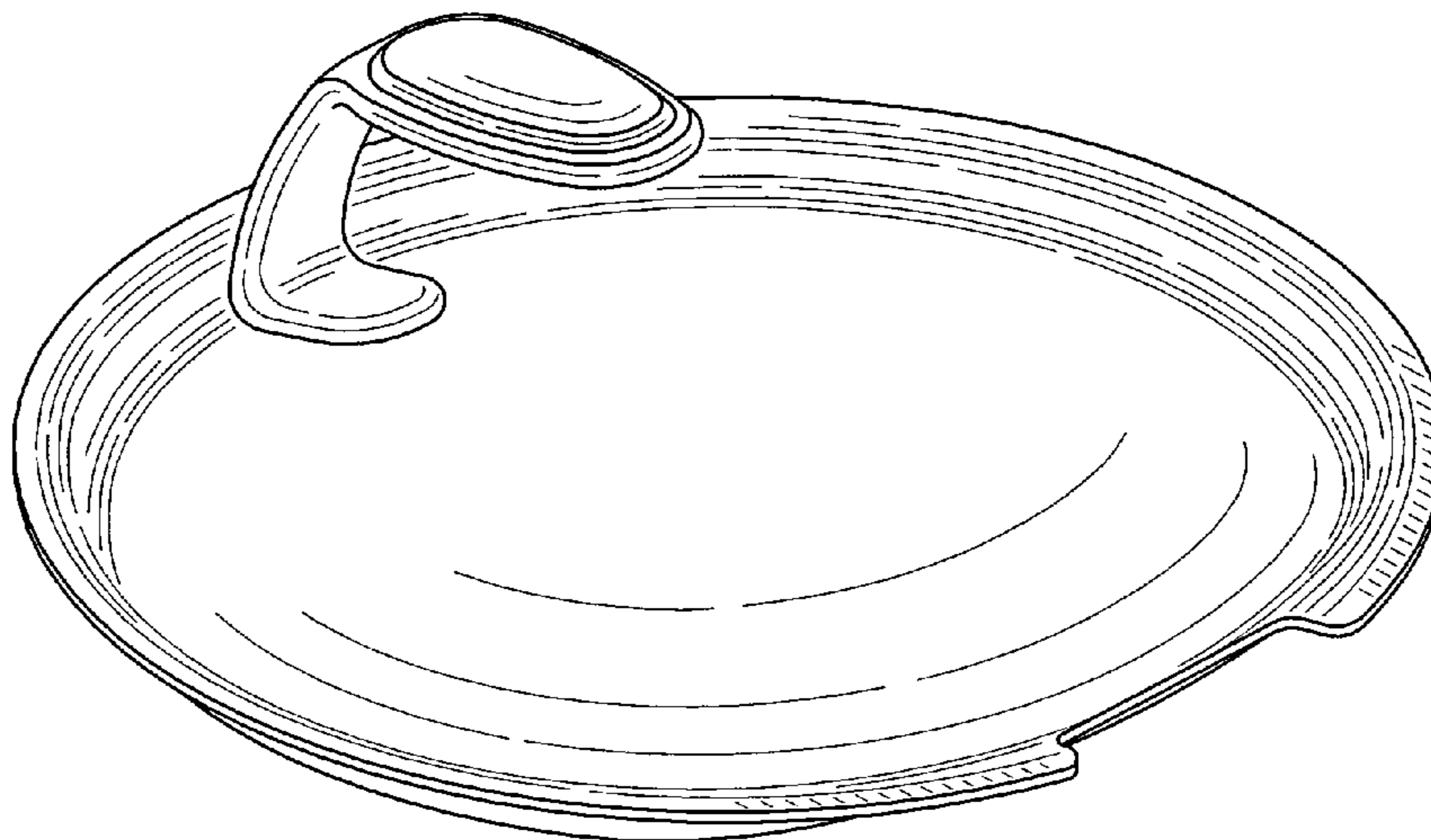

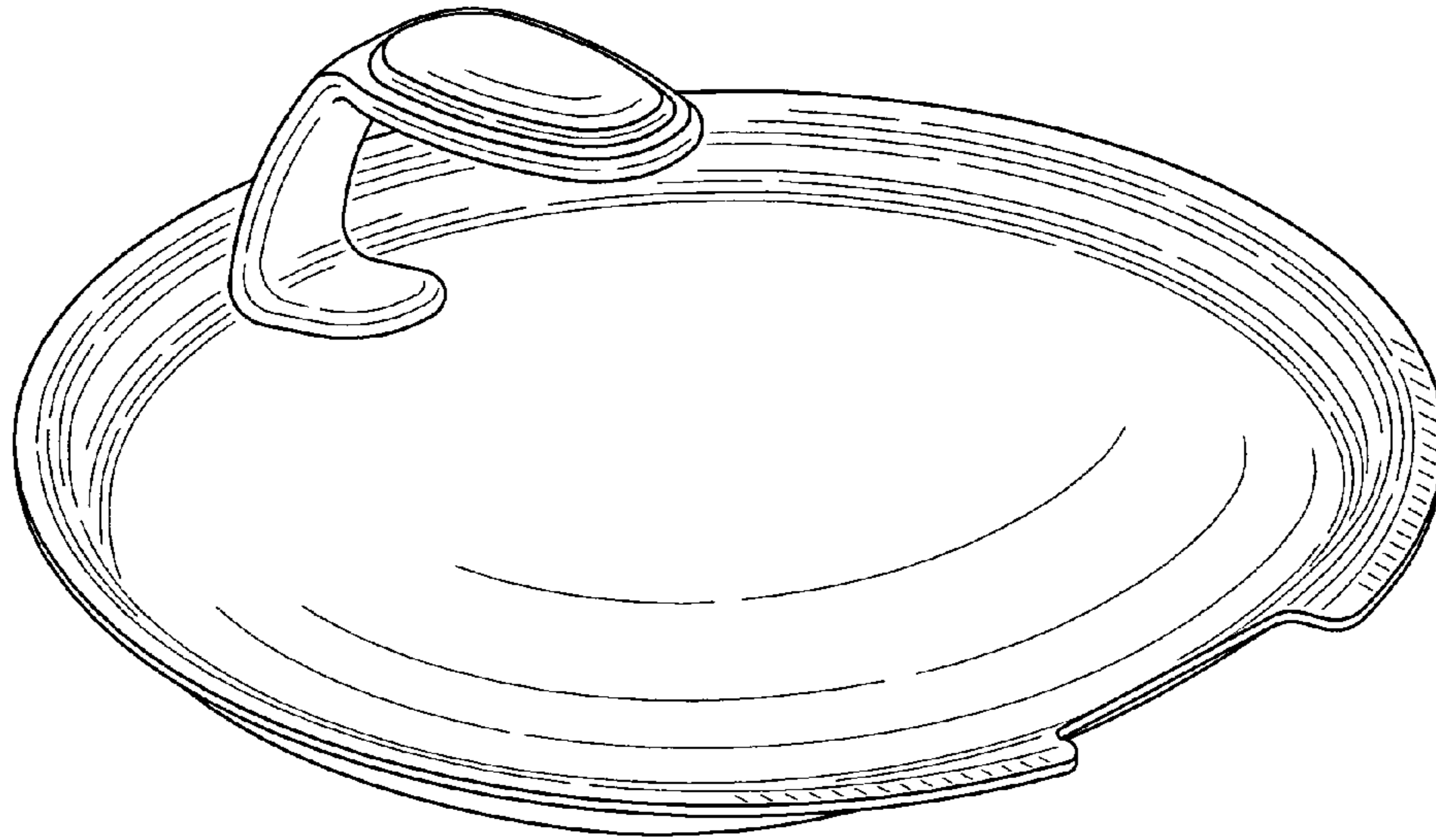

FIG. 1

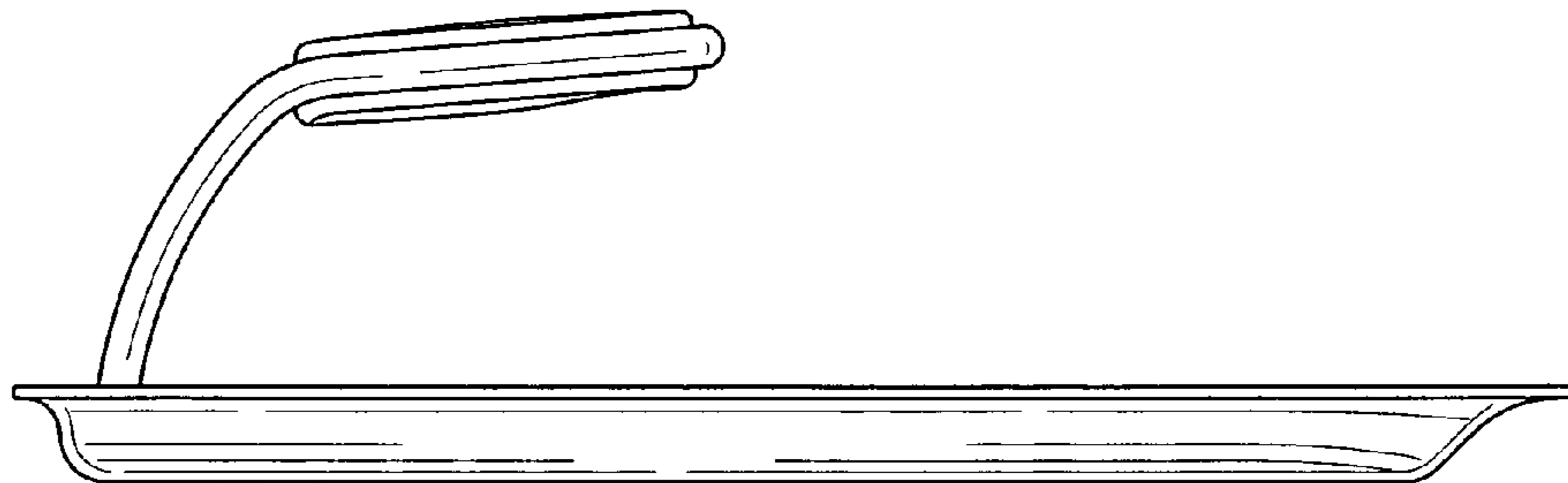

FIG. 2

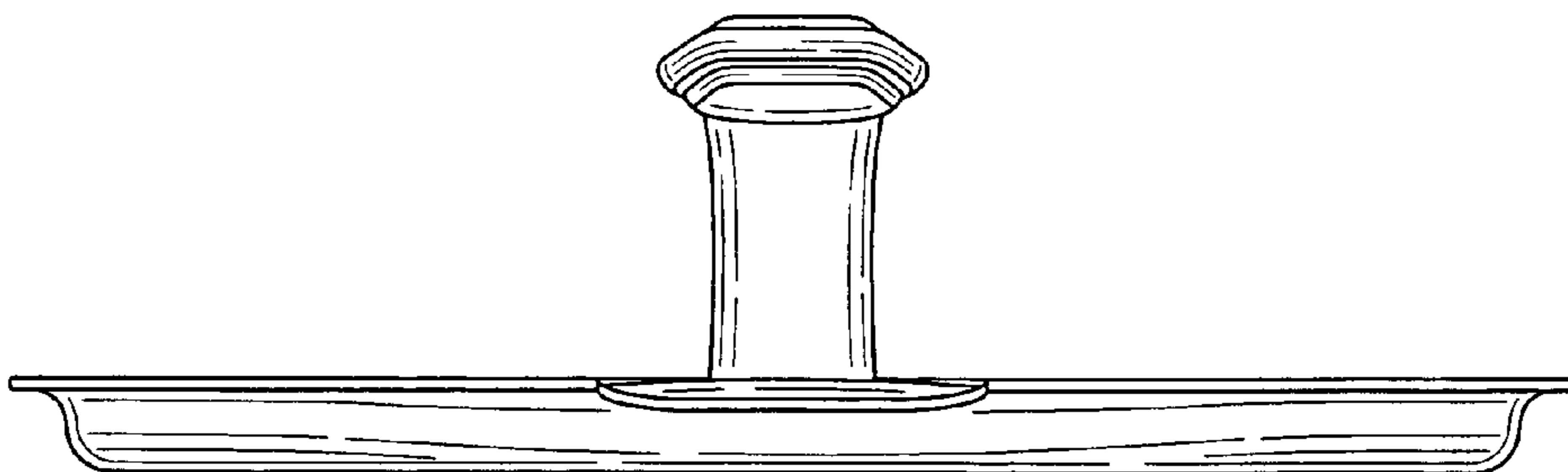

FIG. 3

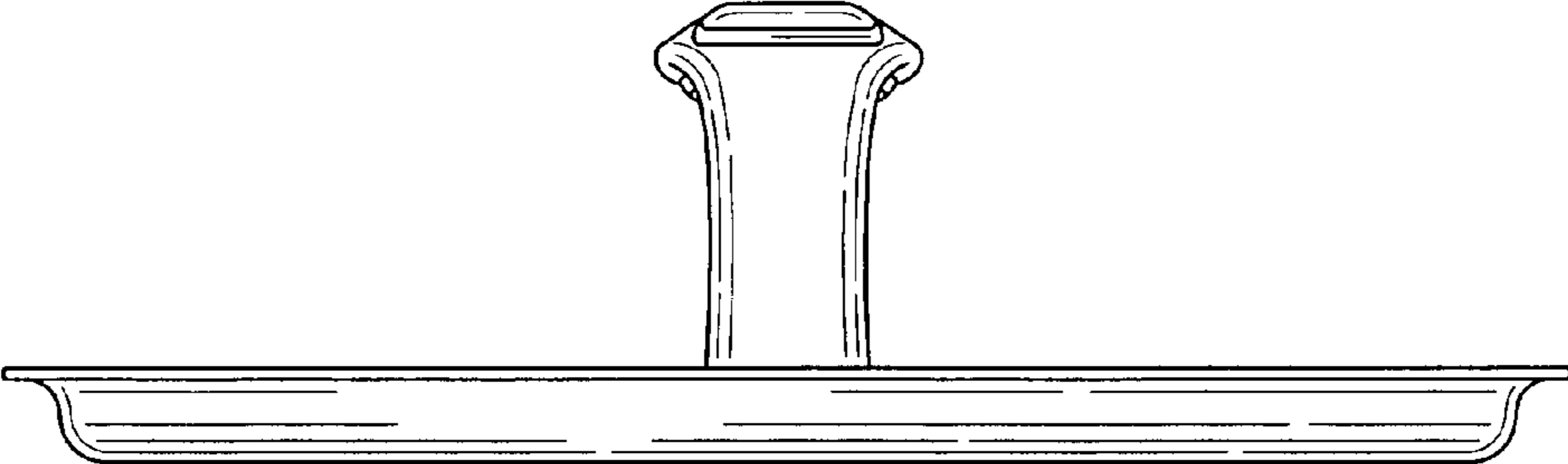

FIG. 4

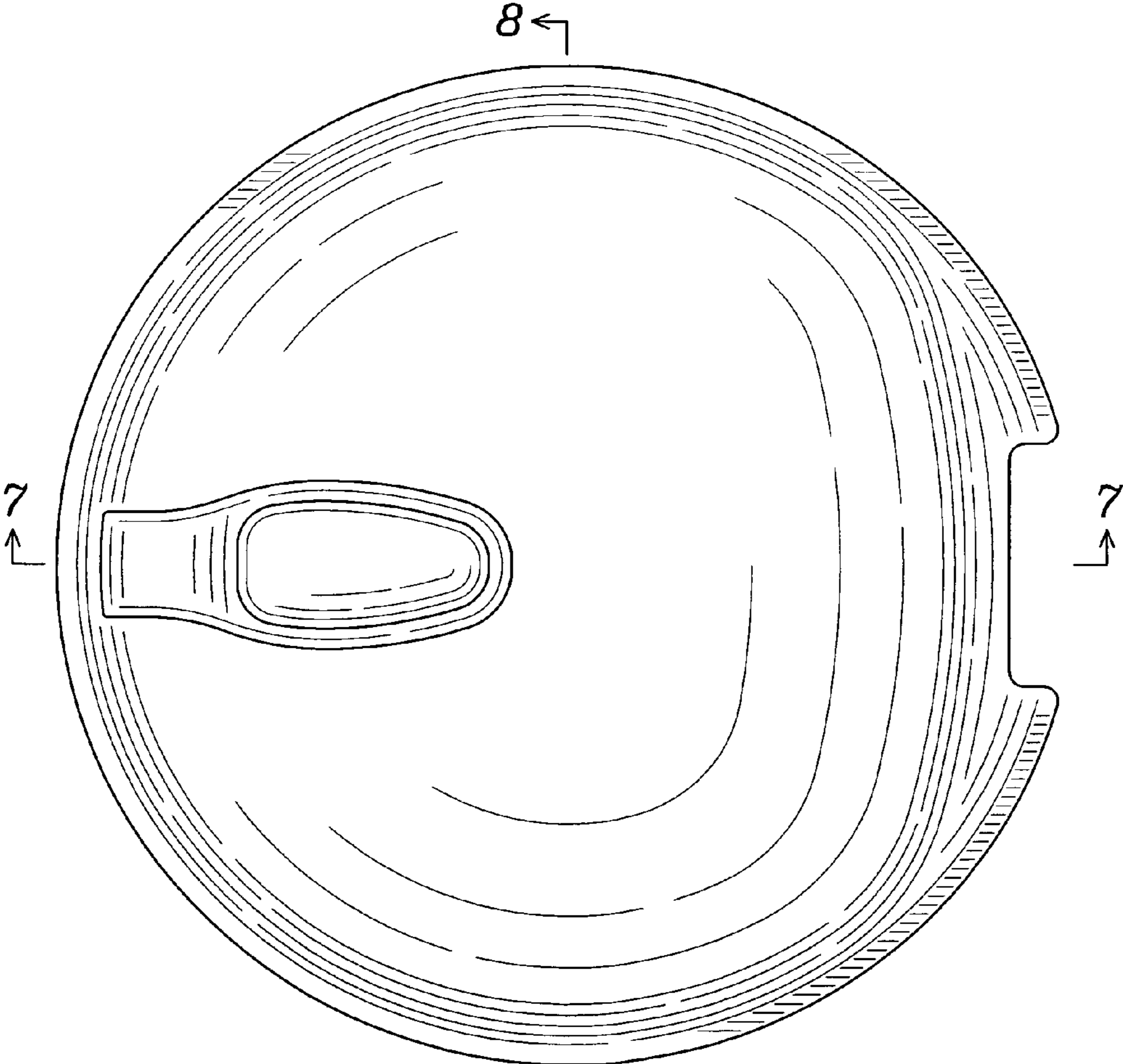

FIG. 5

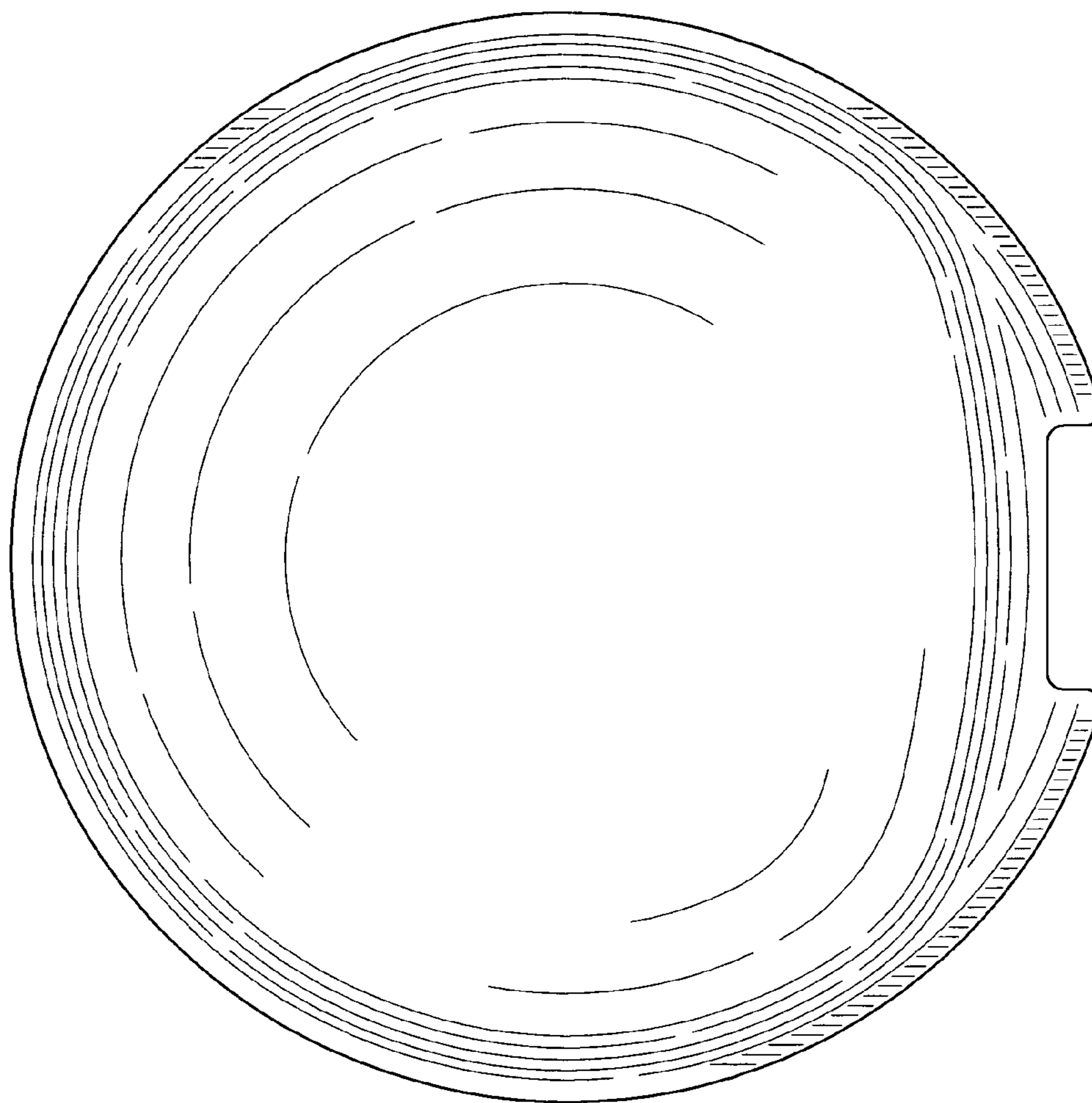

FIG. 6

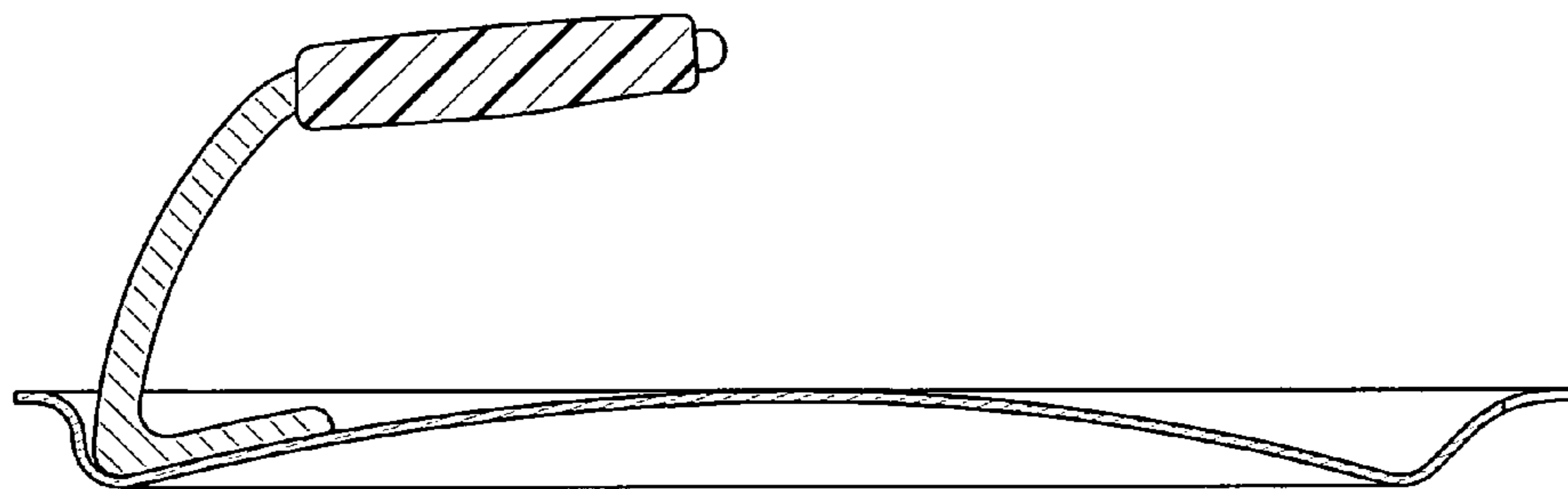

FIG. 7

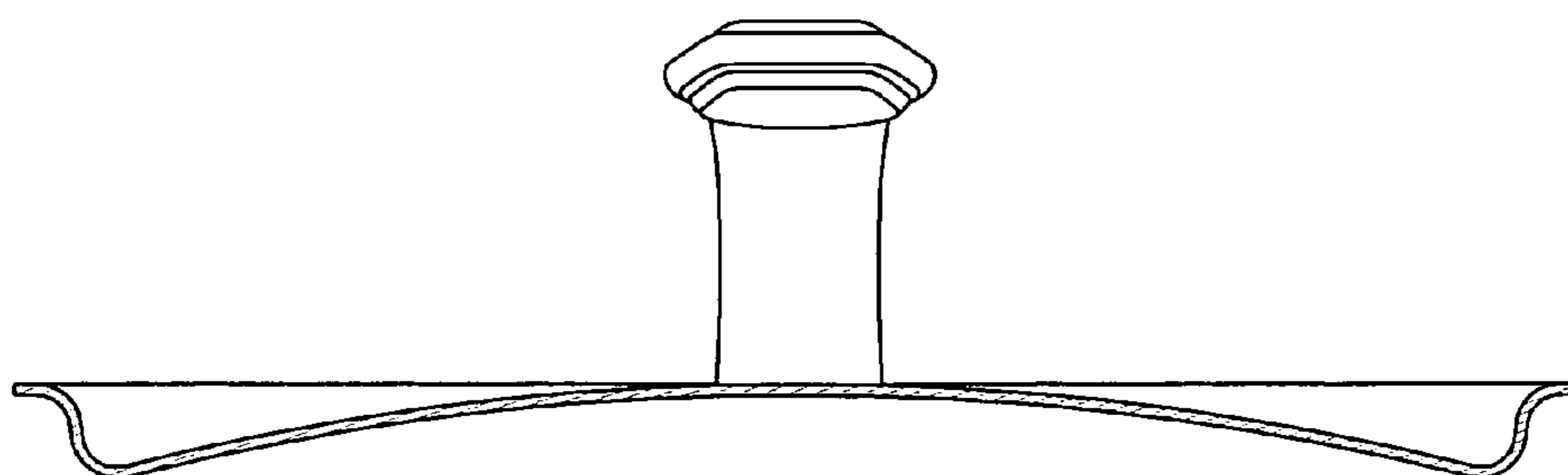

FIG. 8

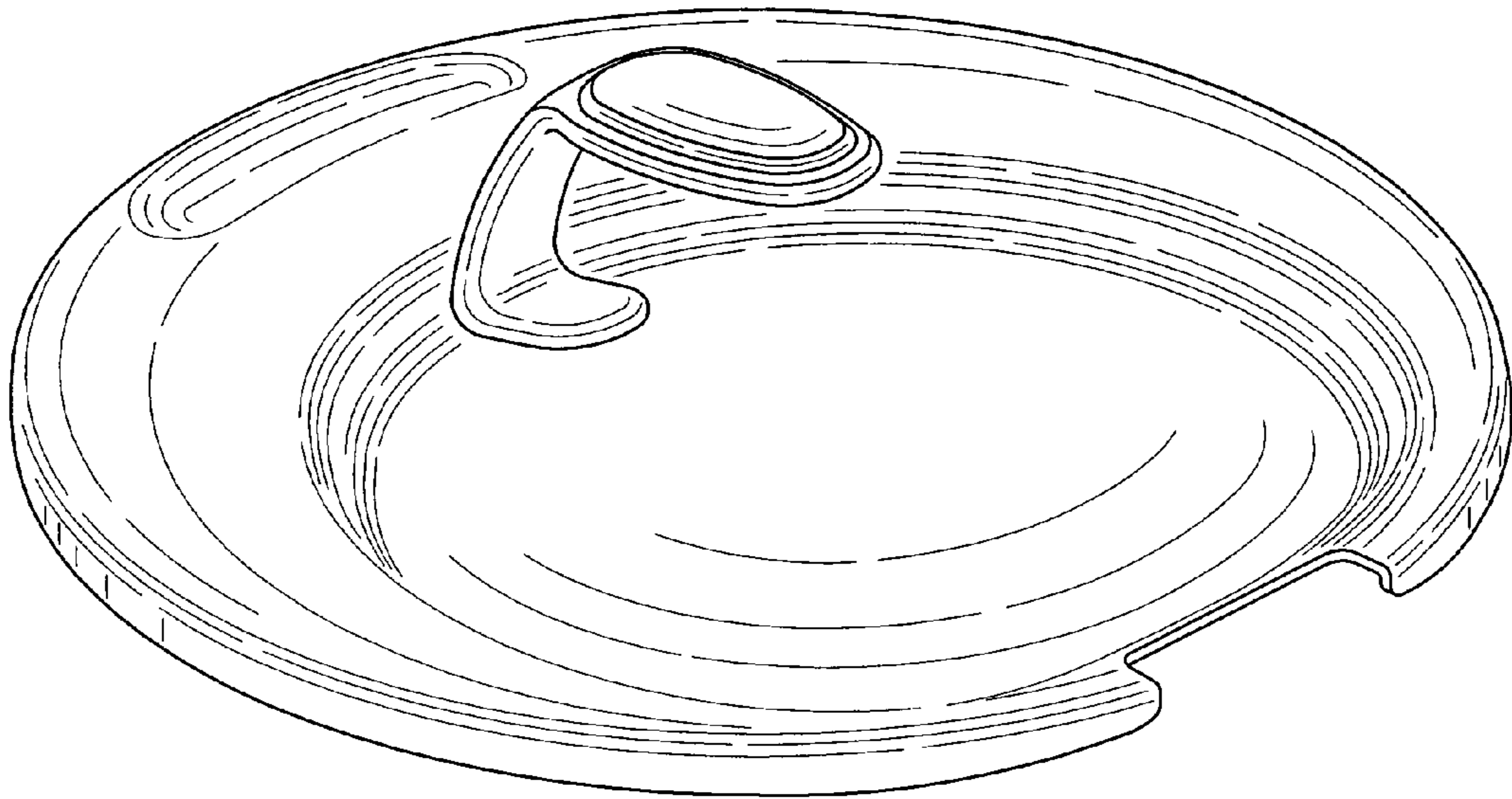

FIG. 9

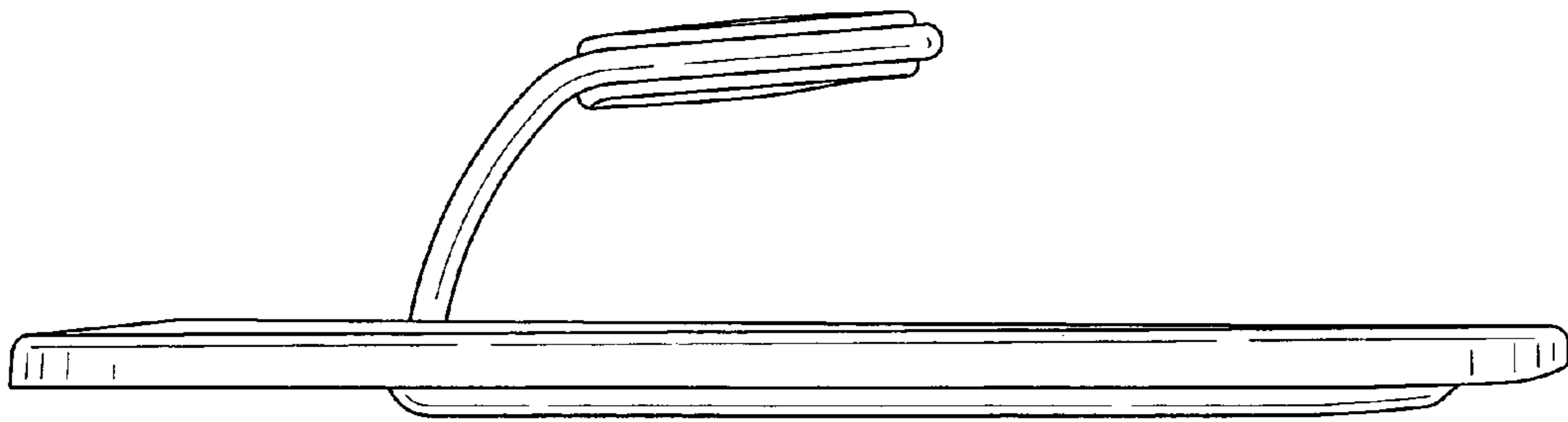

FIG. 10

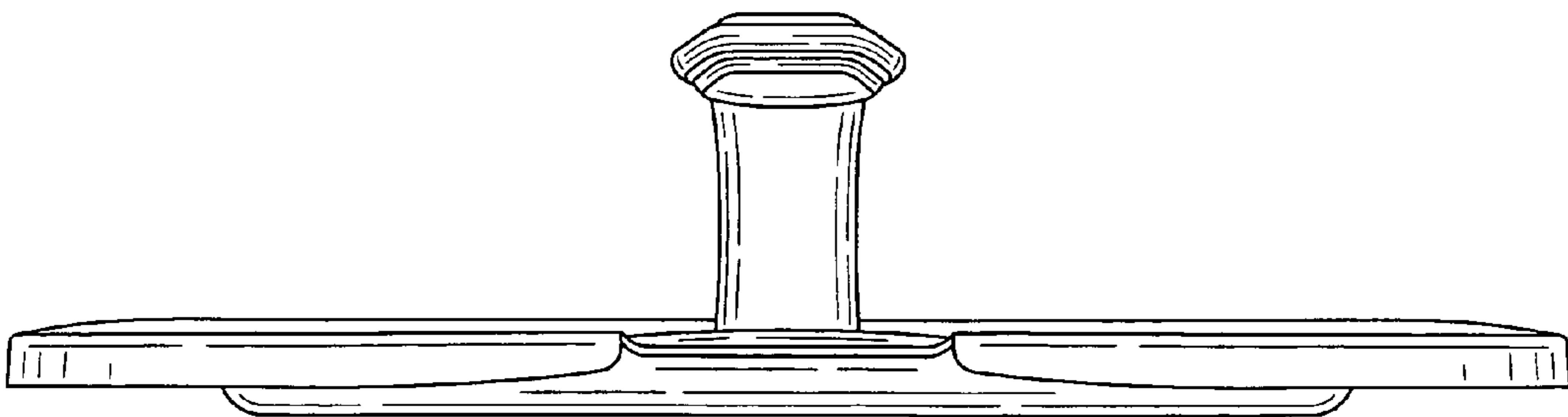

FIG. 11

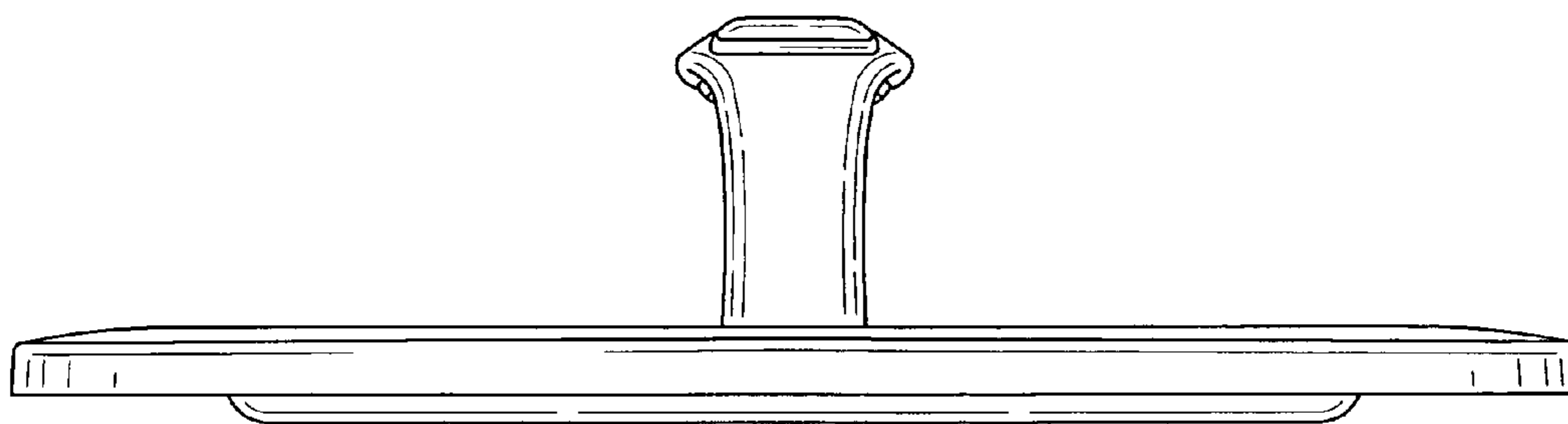

FIG. 12

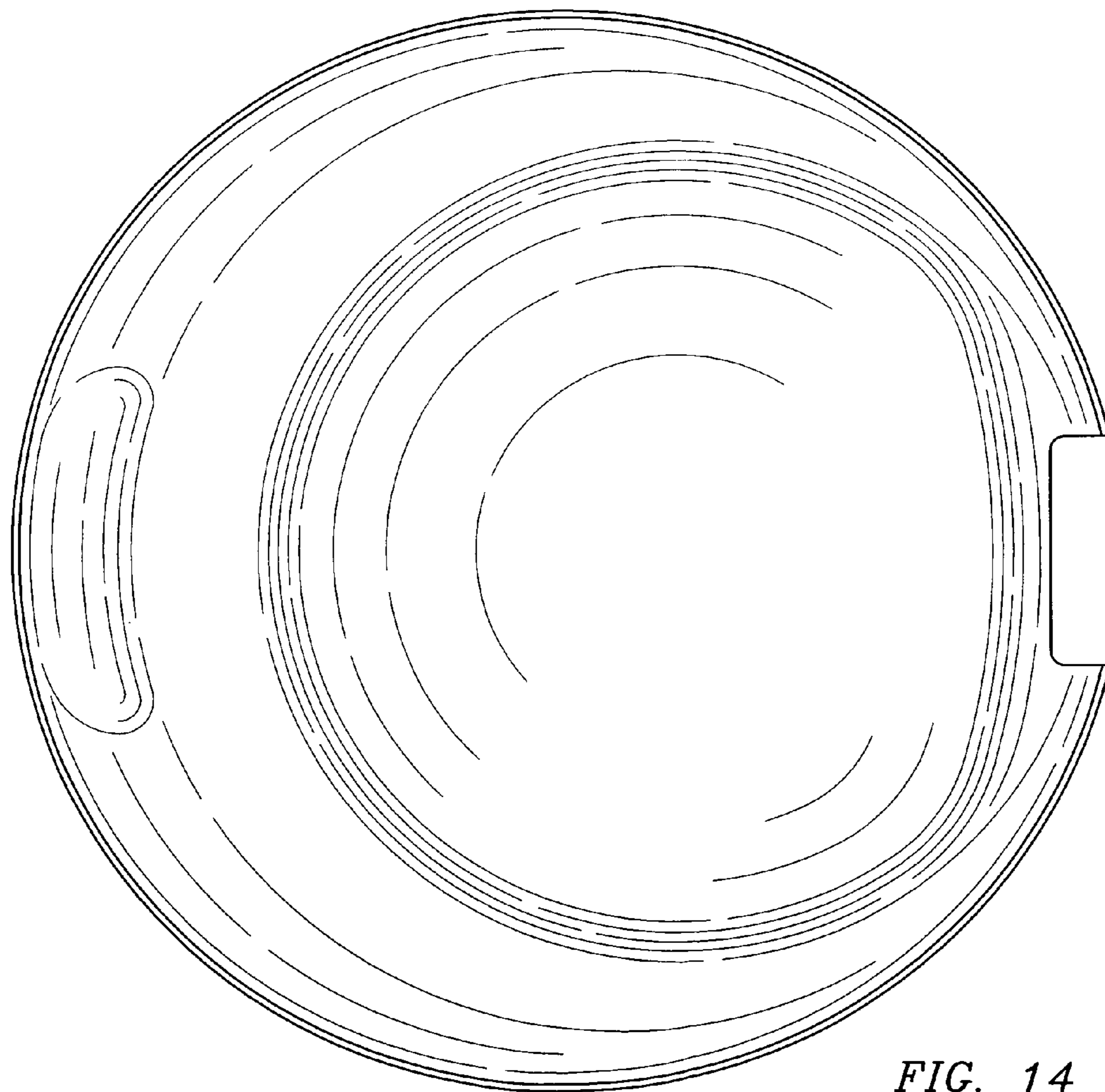

FIG. 14

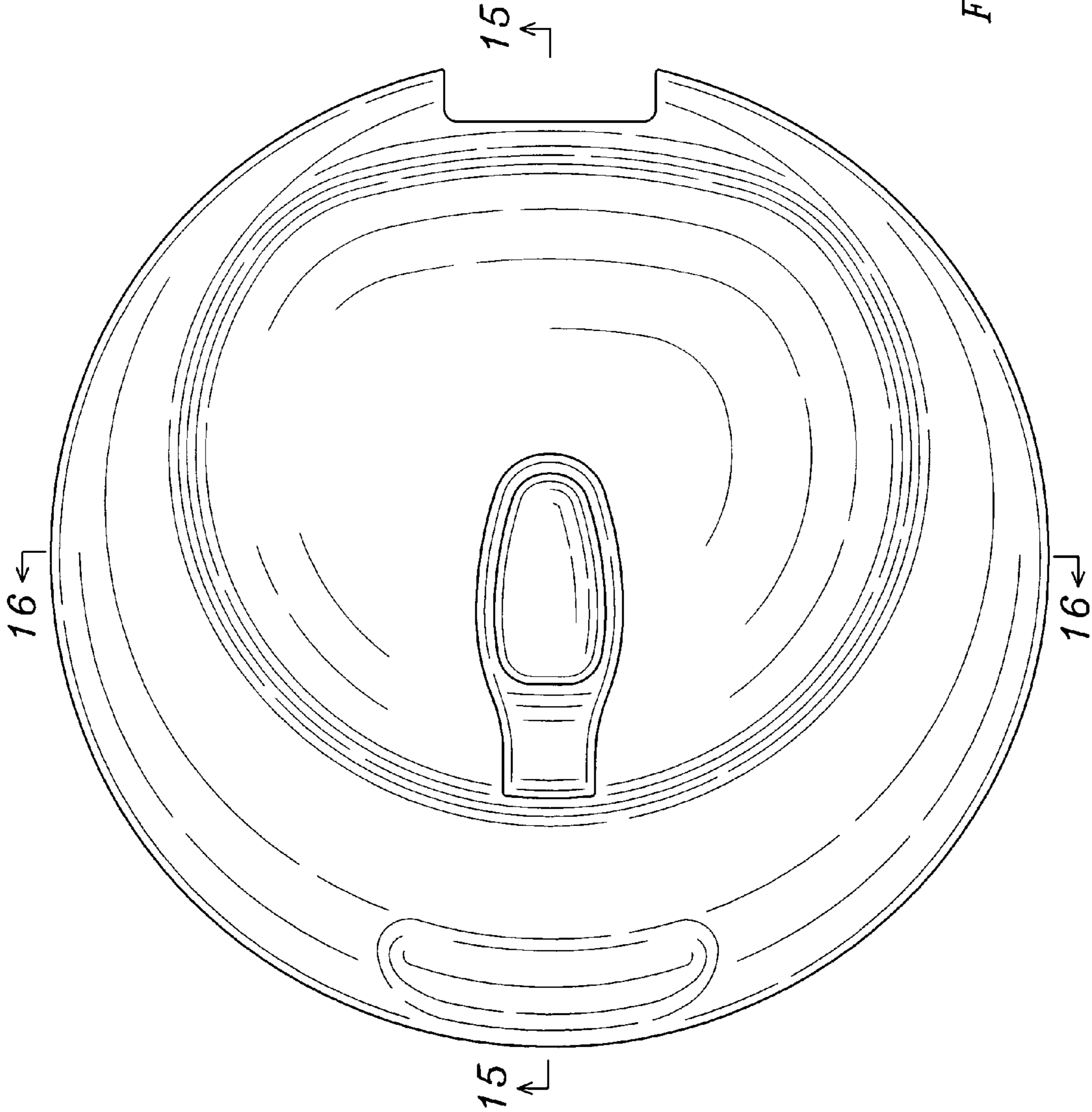

FIG. 13

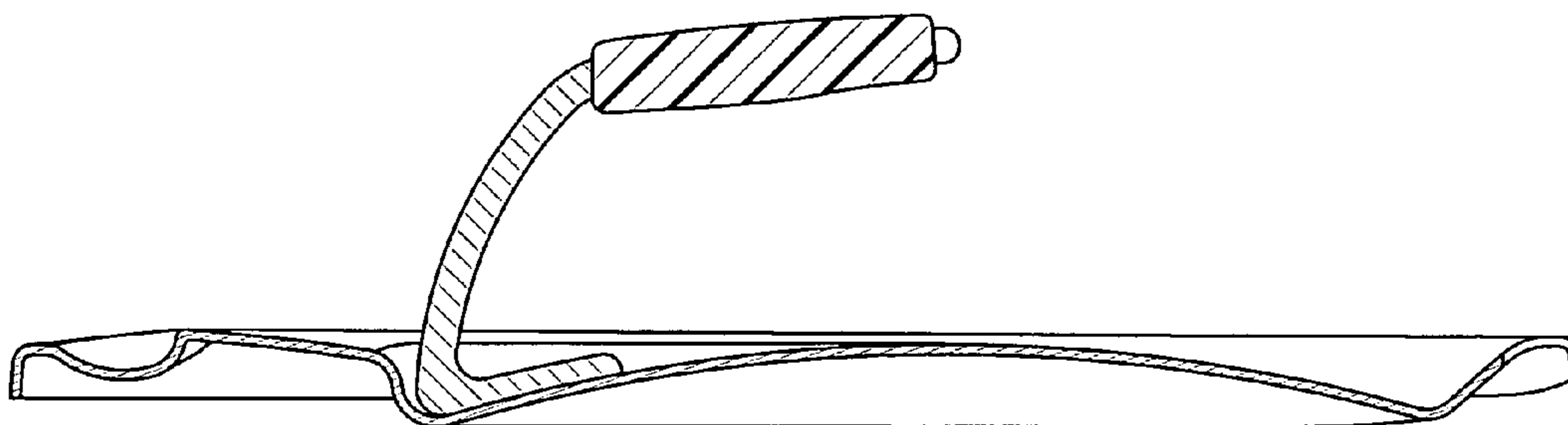

FIG. 15

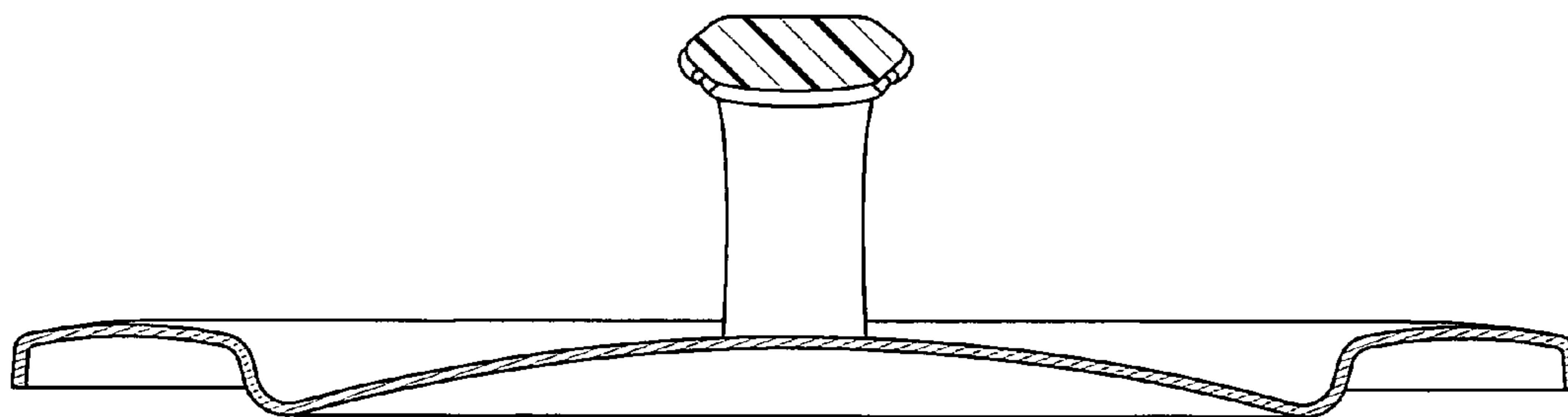

FIG. 16