



US00D650574S

(12) **United States Design Patent**  
**Loth et al.**

(10) **Patent No.:** **US D650,574 S**

(45) **Date of Patent:** **\*\* Dec. 20, 2011**

(54) **SOCK**

(75) Inventors: **Damian Loth**, Vancouver (CA); **Greg Hoscheit**, St. Charles, MN (US)

(73) Assignee: **Lifestyle Medical Group, LLC**, St. Charles, MN (US)

(\*\*) Term: **14 Years**

(21) Appl. No.: **29/377,917**

(22) Filed: **Oct. 27, 2010**

(51) **LOC (9) Cl.** ..... **02-04**

(52) **U.S. Cl.** ..... **D2/980**

(58) **Field of Classification Search** ..... D2/980-994,  
D2/896-897; 2/239-240, 241-242  
See application file for complete search history.

(56) **References Cited**

**U.S. PATENT DOCUMENTS**

D242,829	S	*	12/1976	Connelly	.....	D2/985
D269,477	S	*	6/1983	Brier	.....	D2/994
D290,424	S	*	6/1987	Lindecker	.....	D2/994
D392,795	S	*	3/1998	Ogden	.....	D2/980
5,784,721	A	*	7/1998	Huff	.....	2/239
D397,863	S	*	9/1998	Van De Steeg	.....	D2/987
D401,758	S	*	12/1998	Huff	.....	D2/986
D414,601	S	*	10/1999	Cortinovic	.....	D2/989
6,012,177	A	*	1/2000	Cortinovic	.....	2/239
D429,557	S	*	8/2000	Cortinovic	.....	D2/980
D437,480	S	*	2/2001	Cortinovic	.....	D2/989
D479,040	S	*	9/2003	Cortinovic	.....	D2/994
D499,879	S	*	12/2004	Mavis et al.	.....	D2/989
D509,652	S	*	9/2005	Cooper	.....	D2/980
D512,829	S	*	12/2005	Viveros et al.	.....	D2/989
D513,116	S	*	12/2005	Gaither	.....	D2/989
7,082,703	B2	*	8/2006	Greene et al.	.....	36/89
7,681,254	B2	*	3/2010	Lambertz	.....	2/239
D627,147	S	*	11/2010	Lambertz	.....	D2/994

2006/0143801	A1	*	7/2006	Lambertz	.....	2/239
2007/0118973	A1	*	5/2007	Lambertz	.....	2/239
2009/0113602	A1	*	5/2009	Lambertz	.....	2/239
2009/0165190	A1	*	7/2009	Araki et al.	.....	2/240
2009/0178179	A1	*	7/2009	Liu	.....	2/239
2009/0282607	A1	*	11/2009	Kaneda	.....	2/239

\* cited by examiner

*Primary Examiner* — T. Chase Nelson

*Assistant Examiner* — Kathleen M Sims

(74) *Attorney, Agent, or Firm* — Clise, Billion & Cry, P.A.;  
Tim Clise

(57) **CLAIM**

The ornamental design for a sock, as shown and described.

**DESCRIPTION**

FIG. 1 is a perspective view of a first embodiment of a sock showing our new design;

FIG. 2 is a front view thereof;

FIG. 3 is a rear view thereof;

FIG. 4 is right side view;

FIG. 5 is left side view;

FIG. 6 is top view; and

FIG. 7 is bottom view.

FIG. 8 is a perspective view of a second embodiment of a sock showing our new design;

FIG. 9 is a front view thereof;

FIG. 10 is a rear view thereof;

FIG. 11 is right side view;

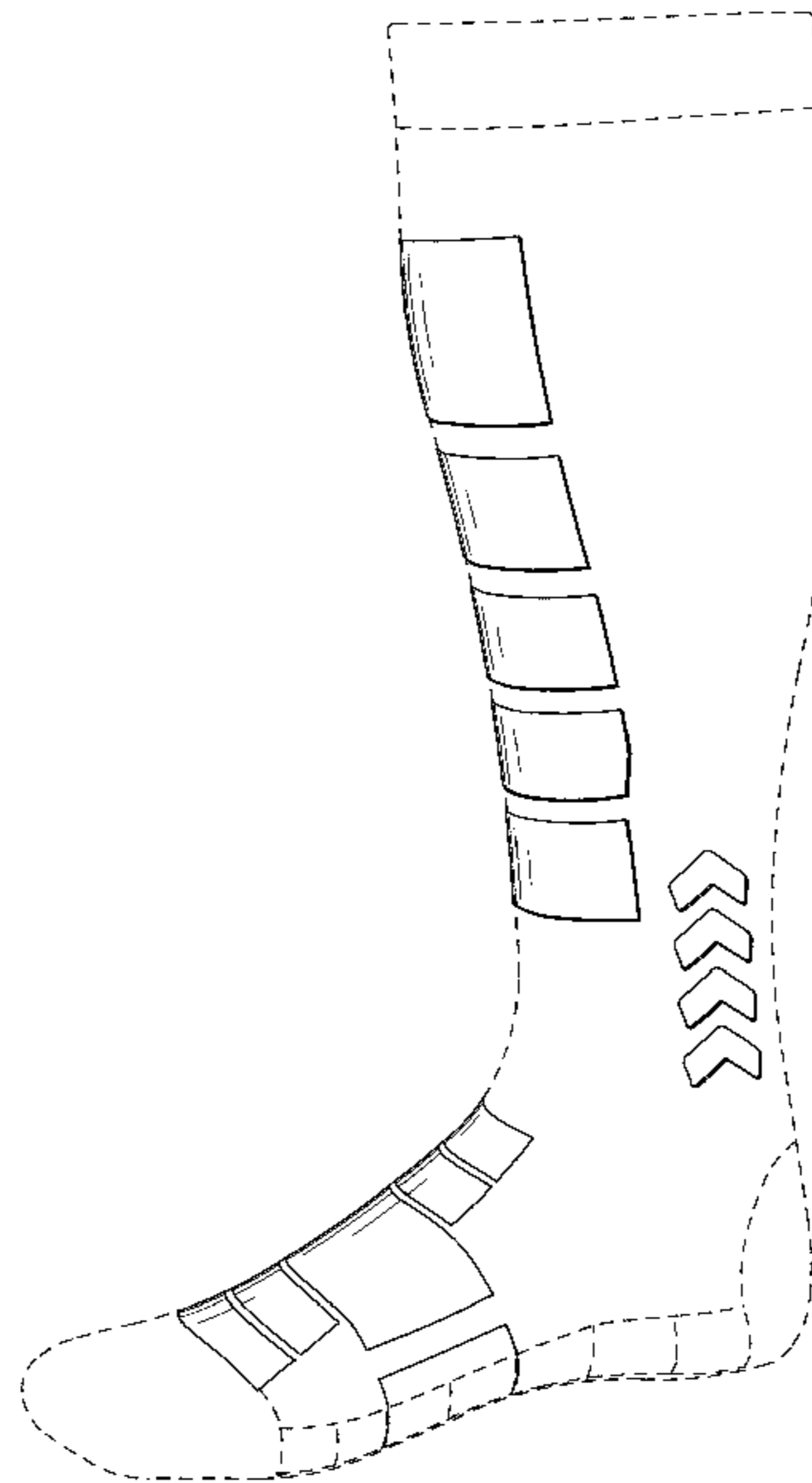
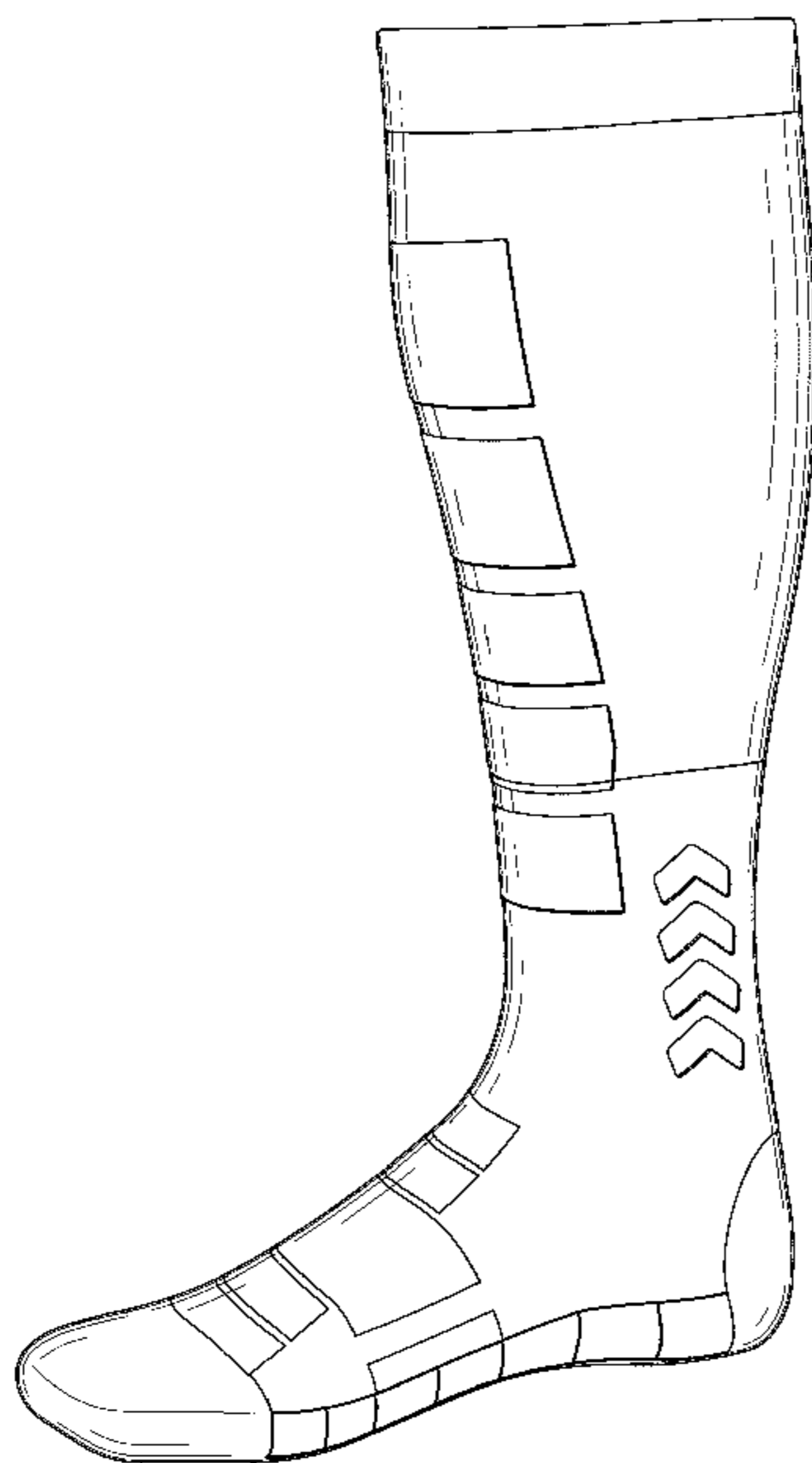
FIG. 12 is left side view;

FIG. 13 is top view; and,

FIG. 14 is bottom view.

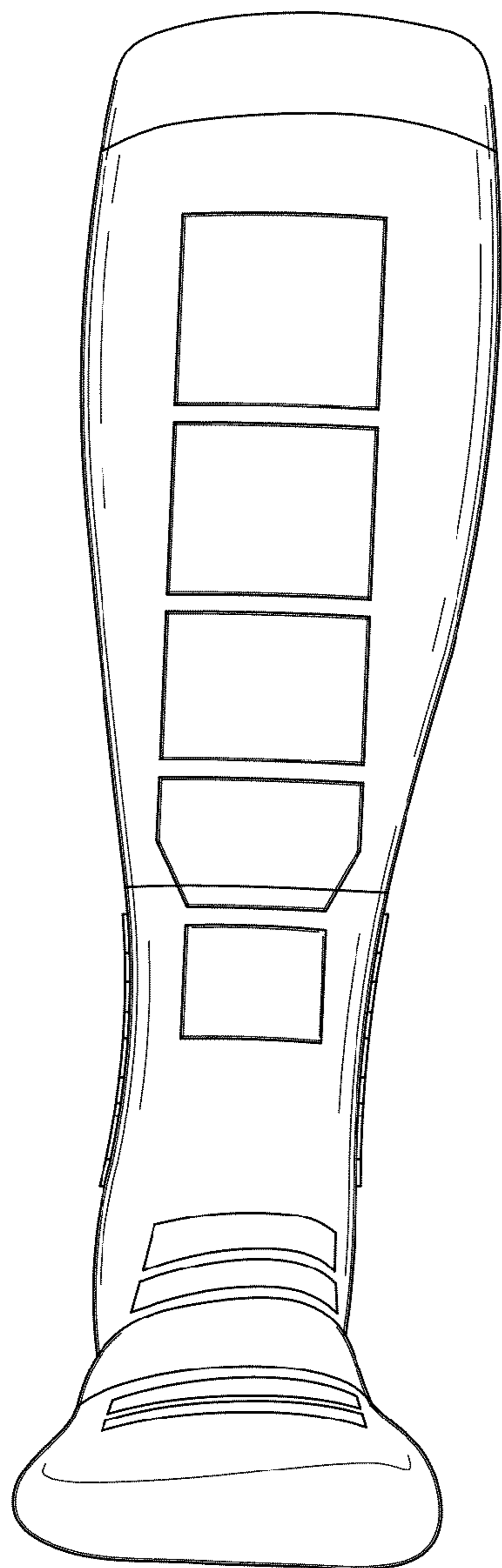
The broken line showing in the drawings are for environmental purposes only and form no part of the claimed design.

**1 Claim, 10 Drawing Sheets**

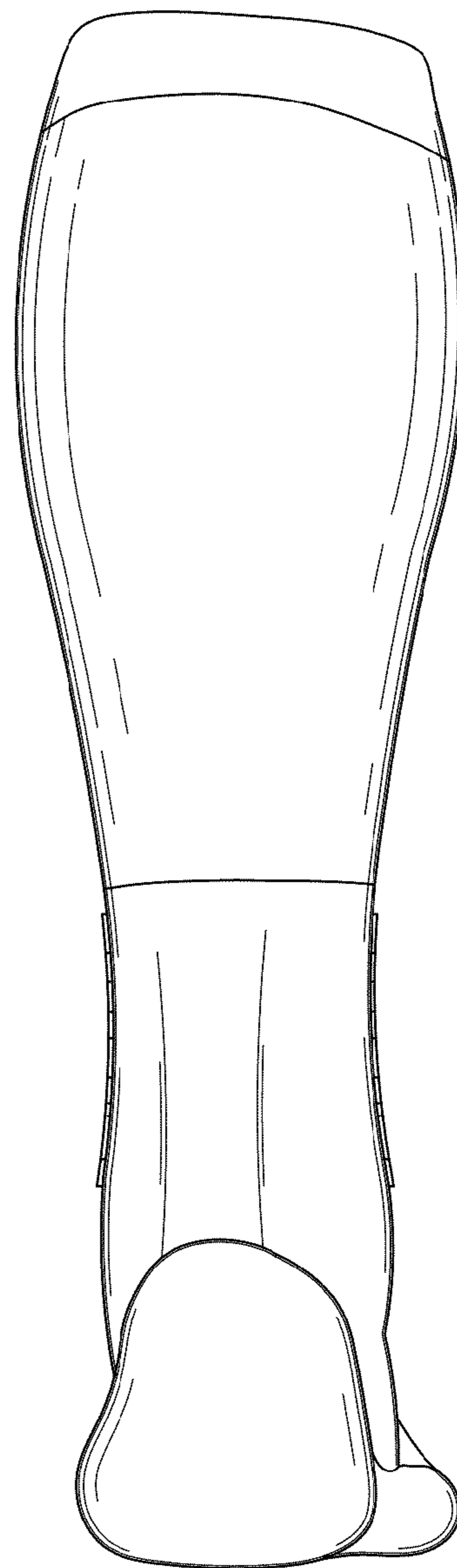




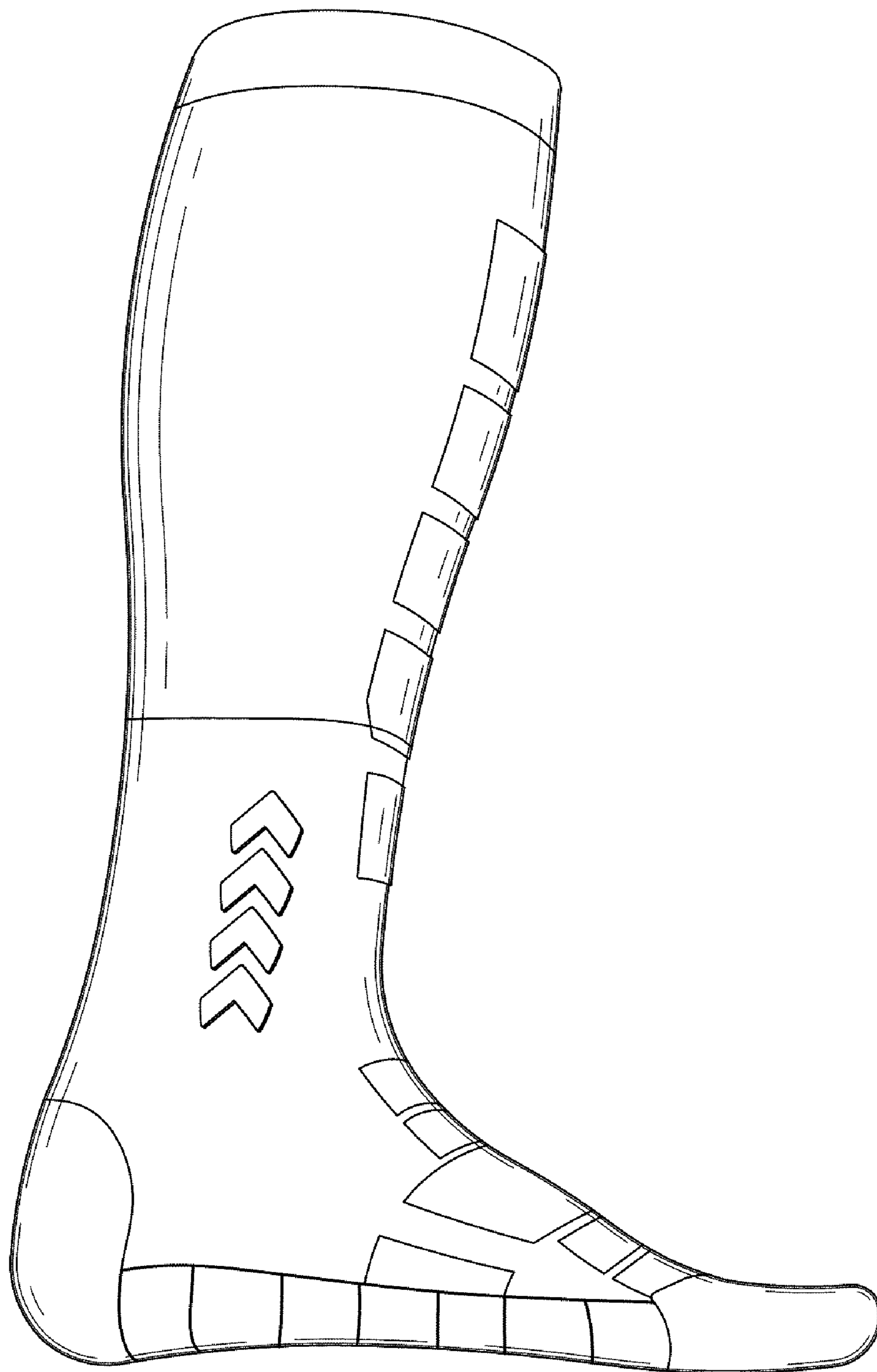
*FIG. 1*



*FIG. 2*



*FIG. 3*

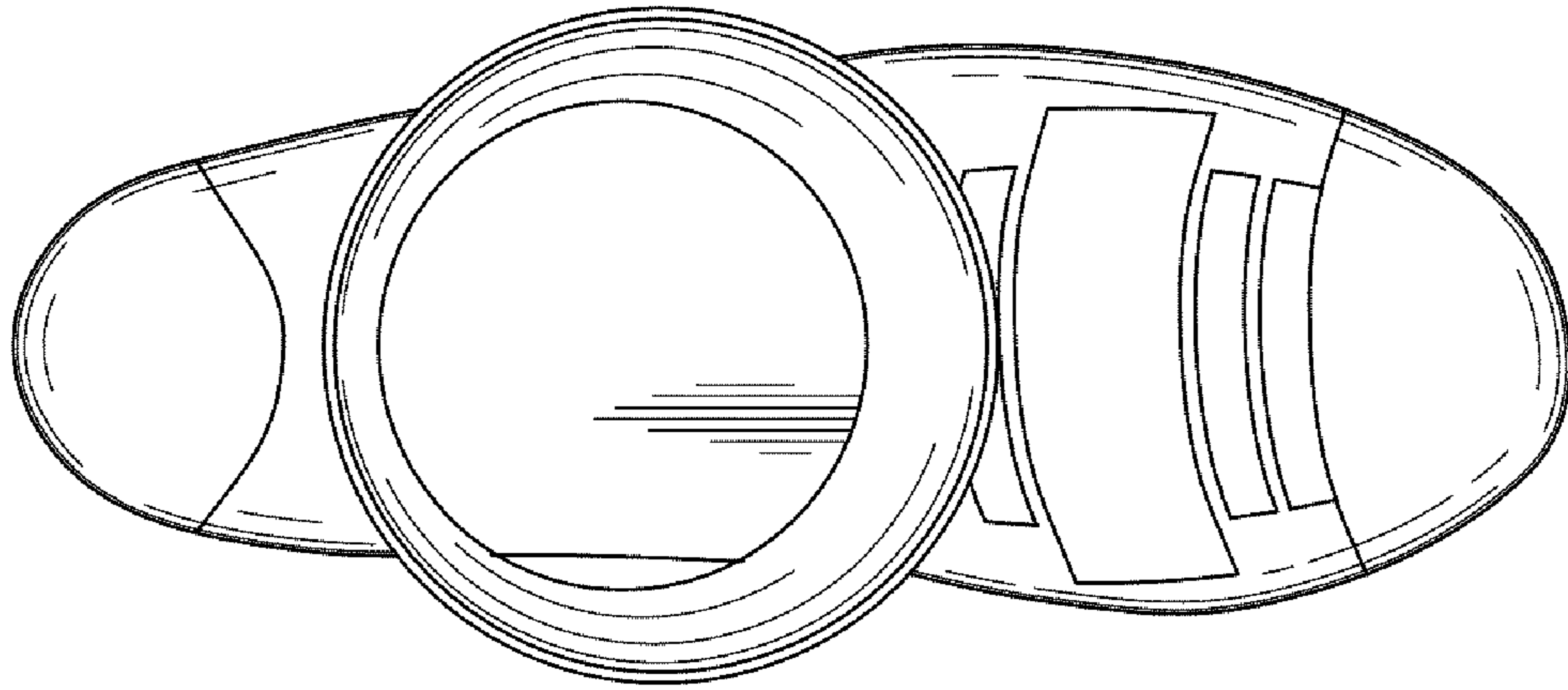


*FIG. 4*

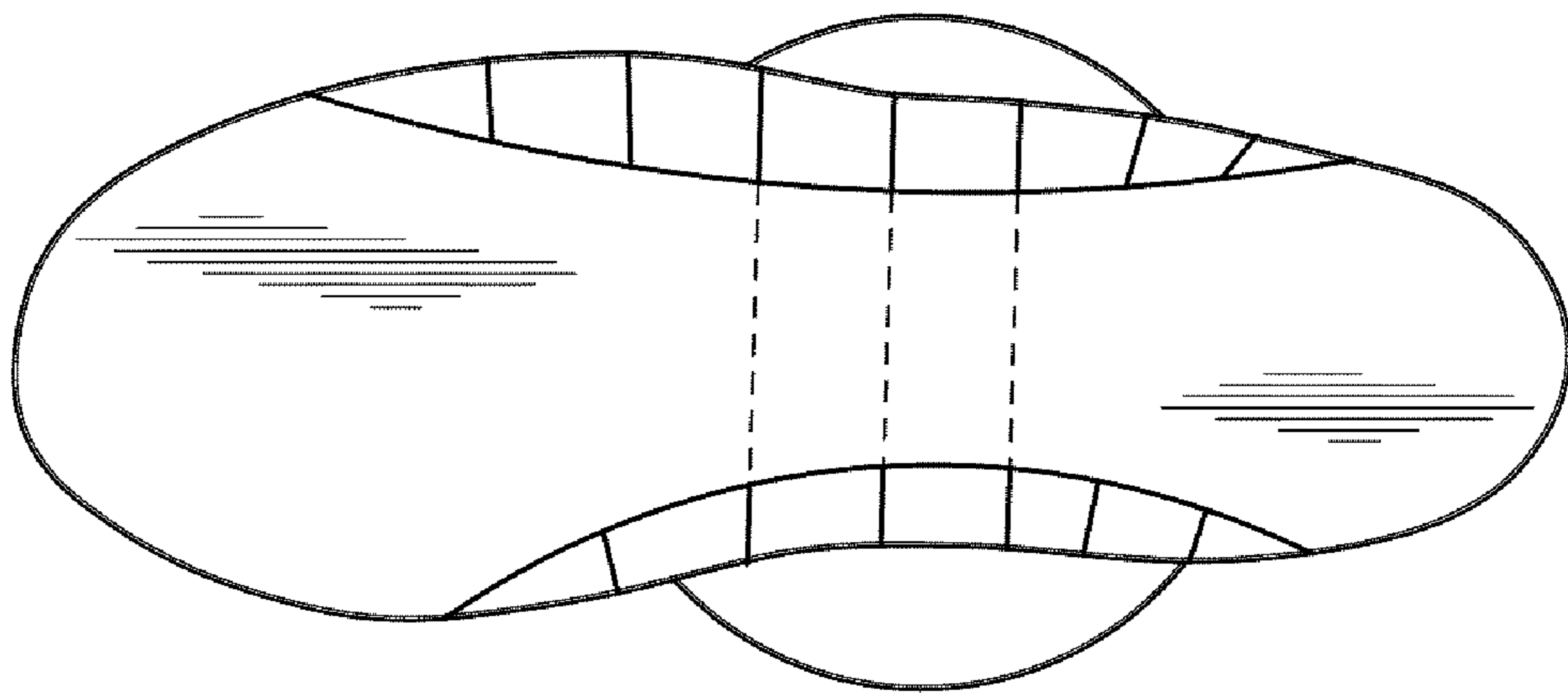


*FIG. 5*

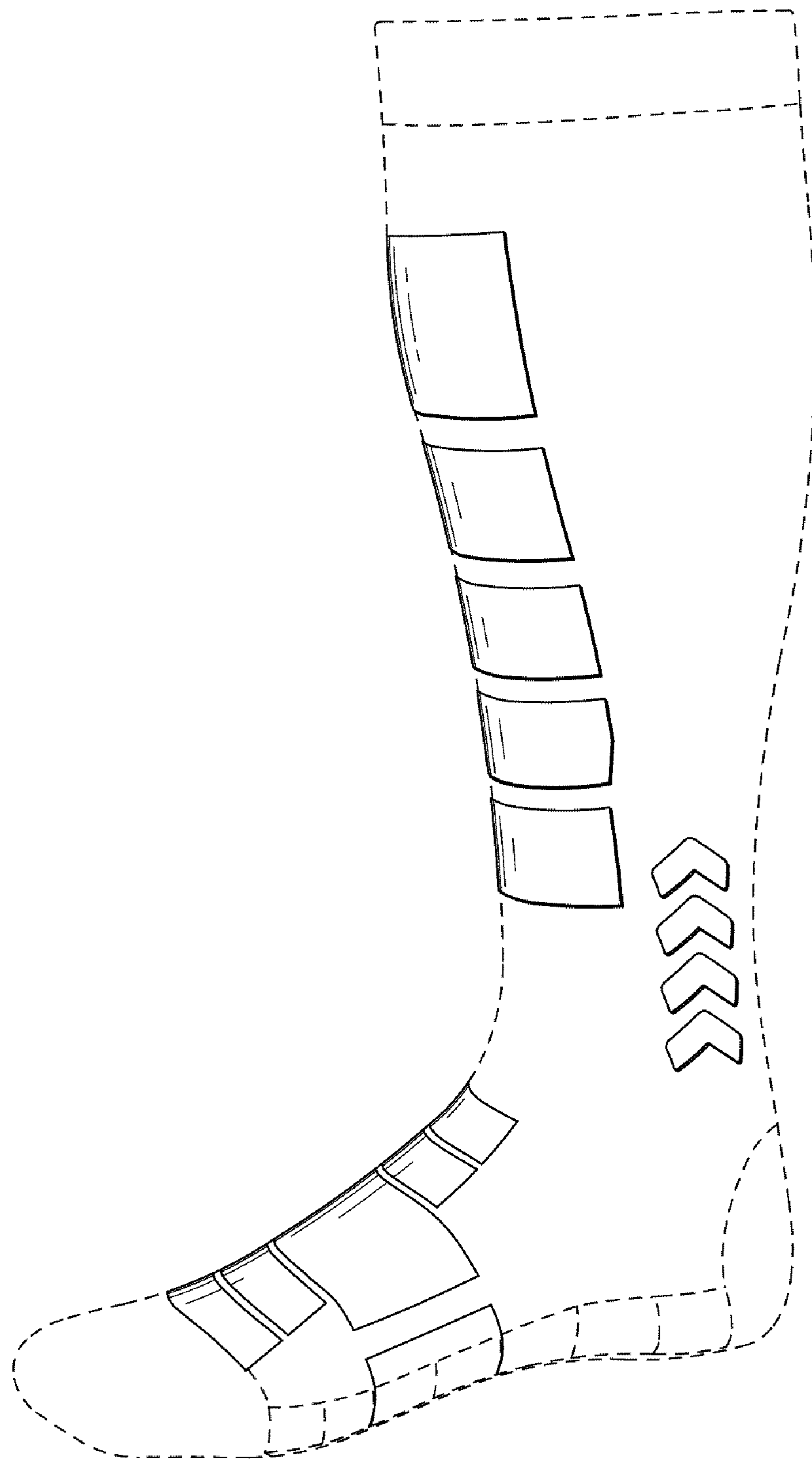




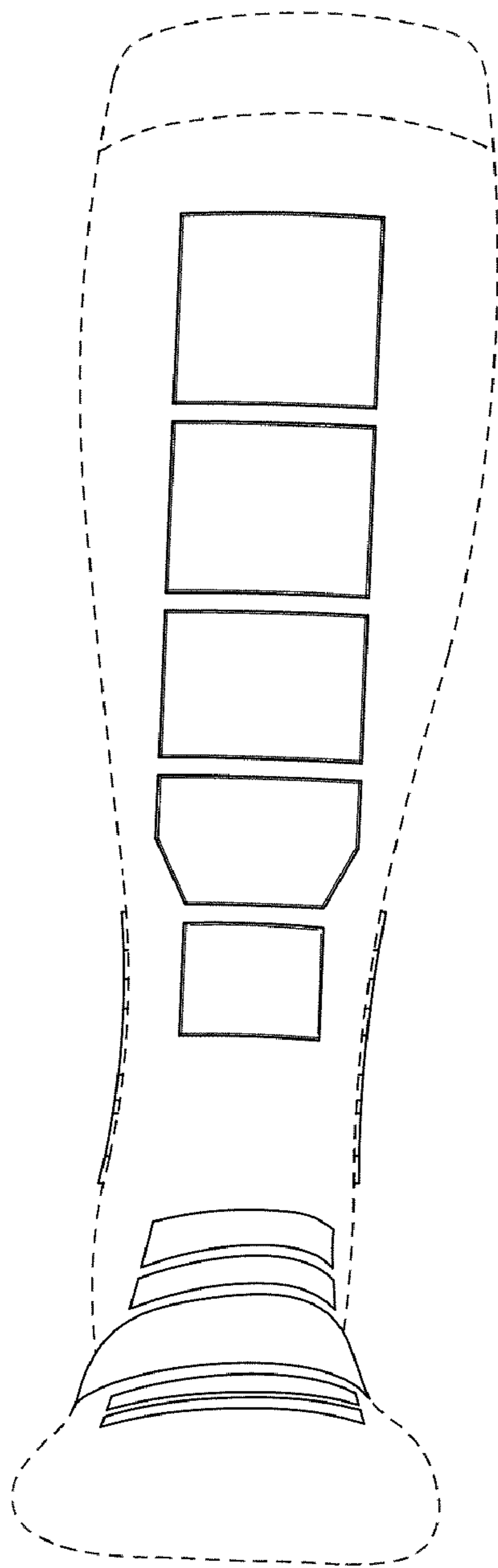
*FIG. 6*



*FIG. 7*



*FIG. 8*

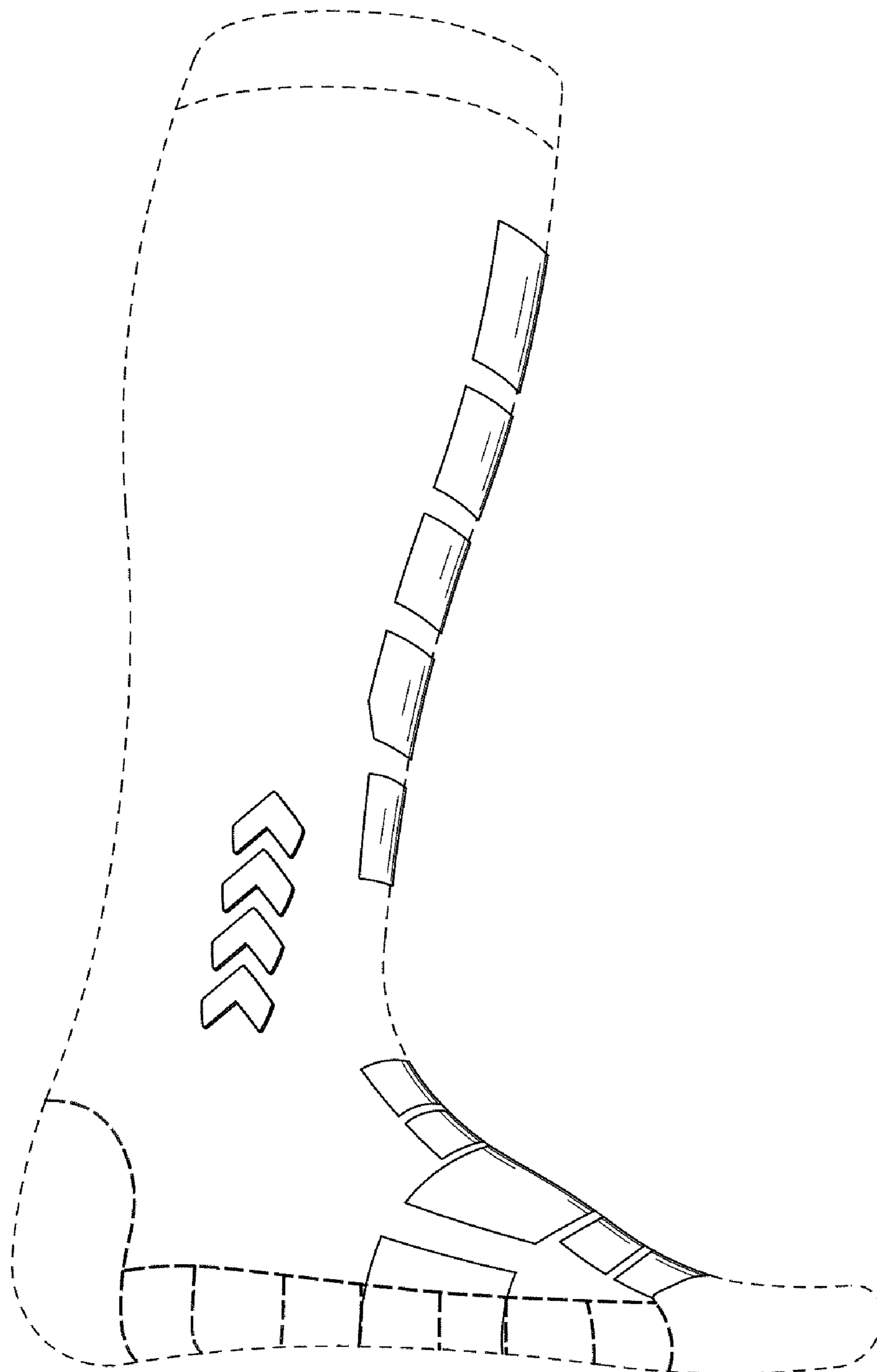


*FIG. 9*

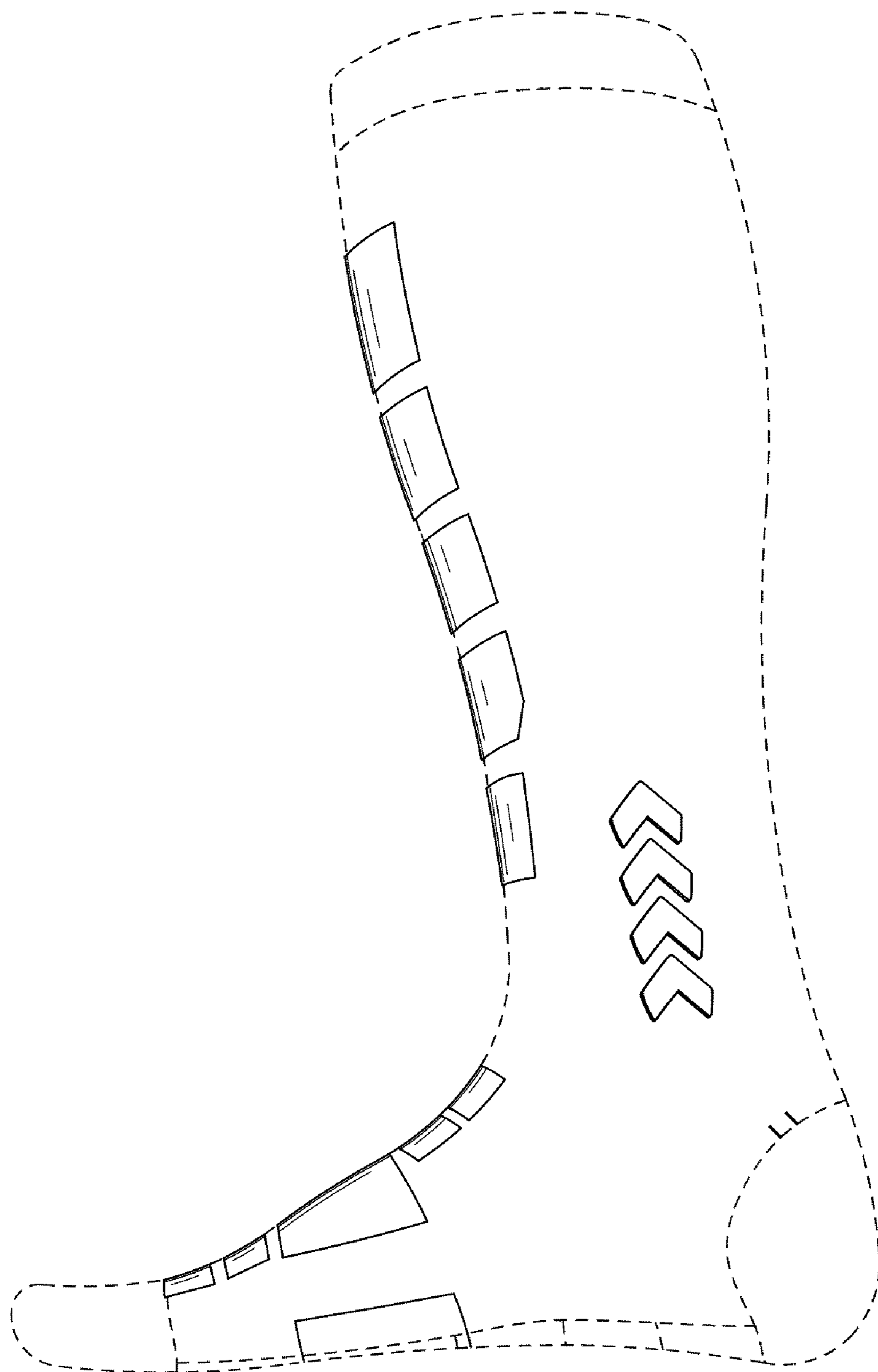


*FIG. 10*

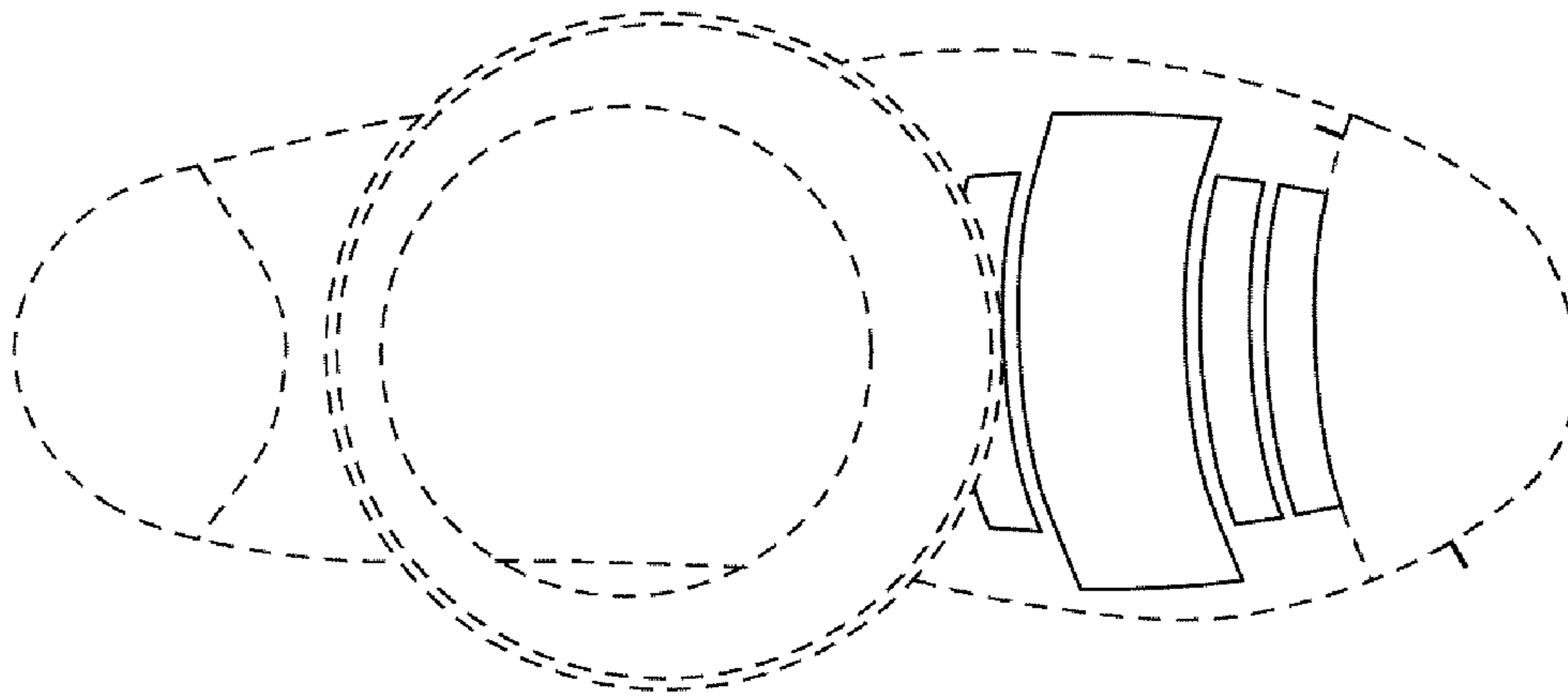




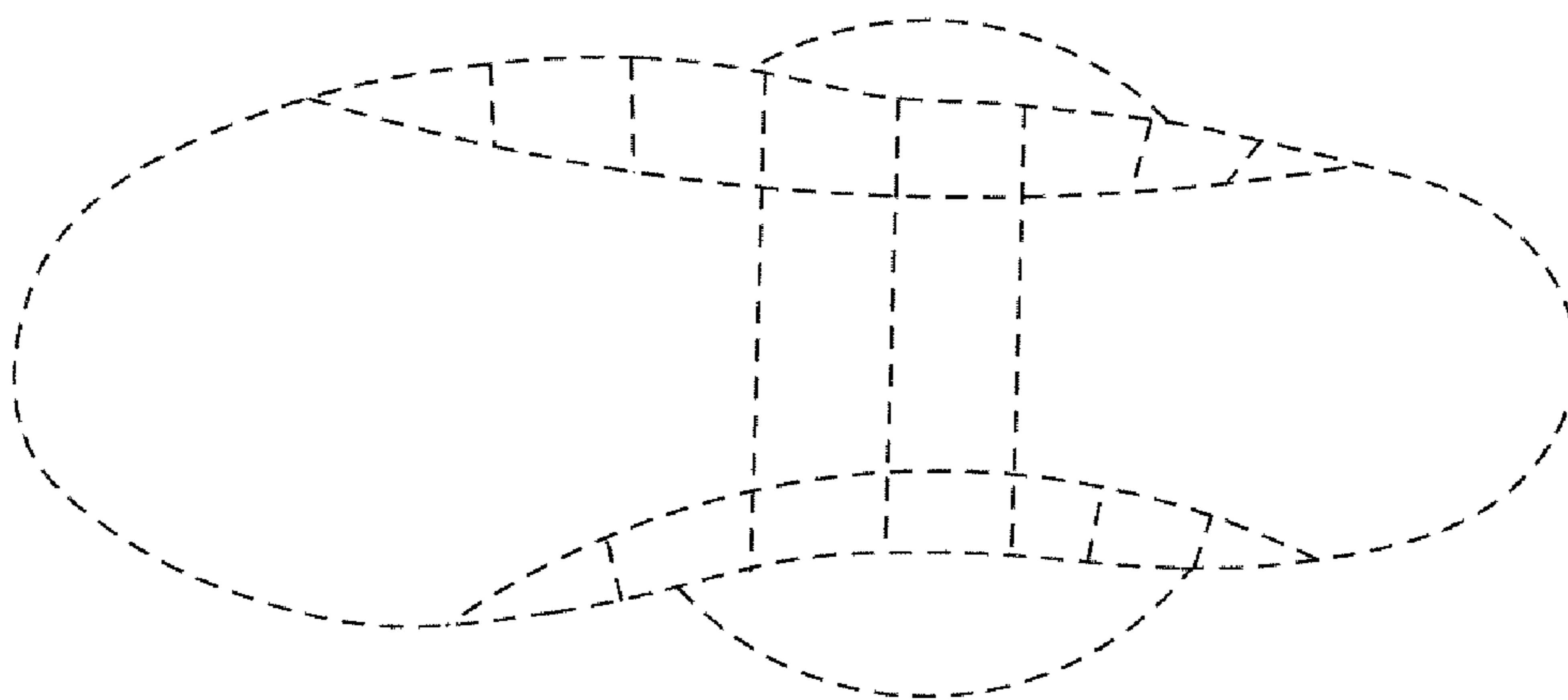
*FIG. 11*



*FIG. 12*



*FIG. 13*



*FIG. 14*