



US00D650353S

(12) **United States Design Patent**  
**Madonna et al.**

(10) **Patent No.:** **US D650,353 S**

(45) **Date of Patent:** **\*\* Dec. 13, 2011**

(54) **MEDIA DEVICE AND HUB ASSEMBLY**

(75) Inventors: **Robert P. Madonna**, Osterville, MA (US); **Kathleen M. Lacey**, Centerville, MA (US); **David Correia**, Fall River, MA (US); **Victor Saverino**, Mashpee, MA (US)

(73) Assignee: **Savant Systems, LLC**, Osterville, MA (US)

(\*\*) Term: **14 Years**

(21) Appl. No.: **29/351,734**

(22) Filed: **Dec. 10, 2009**

(51) **LOC (9) Cl.** ..... **14-01**

(52) **U.S. Cl.** ..... **D14/141.1**

(58) **Field of Classification Search** ..... D14/130, D14/140, 141, 141.1, 141.3, 142, 149, 240, D14/467, 496; D21/330; 455/90.3; 379/428, 379/433, 436, 440, 441, 454, 900  
See application file for complete search history.

(56) **References Cited**

U.S. PATENT DOCUMENTS

D321,348 S *	11/1991	Harden et al. ....	D14/141.1
D333,304 S *	2/1993	Taniuchi et al. ....	D14/467
D348,674 S *	7/1994	Lindeman et al. ....	D14/141.3
D513,042 S *	12/2005	Kim et al. ....	D21/330
D559,225 S *	1/2008	Denhez et al. ....	D14/140
D602,499 S *	10/2009	Lewis ....	D14/496
7,881,678 B2 *	2/2011	Menden et al. ....	455/90.3

\* cited by examiner

*Primary Examiner* — Susan Bennett Hattan

*Assistant Examiner* — Barbara B Lohr

(74) *Attorney, Agent, or Firm* — Cesari and McKenna, LLP; John F. McKenna

(57) **CLAIM**

The ornamental design of a media device and hub assembly, as shown.

**DESCRIPTION**

FIG. 1 is a front elevational view of a media device and hub assembly showing our new design; FIG. 2 is a rear elevational view thereof; FIG. 3 is a top plan view thereof; FIG. 4 is a bottom plan view thereof; FIG. 5 is a left side elevational view thereof, the right side being a mirror image of the left side; FIG. 6 is a front elevational view showing the hub's device docking station; FIG. 7 is a fragmentary sectional view taken along line 7-7 of FIG. 6 showing the docking station; FIG. 8 is a front elevational view of a second assembly embodiment; FIG. 9 is a rear elevational view thereof; FIG. 10 is a top plan view thereof; FIG. 11 is a bottom plan view thereof; FIG. 12 is a left side elevational view thereof, the right side being a mirror image of the left side; FIG. 13 is a front elevational view showing the hub's device docking station; and, FIG. 14 is a fragmentary sectional view taken along line 14-14 of FIG. 13 showing the docking station.

**1 Claim, 6 Drawing Sheets**

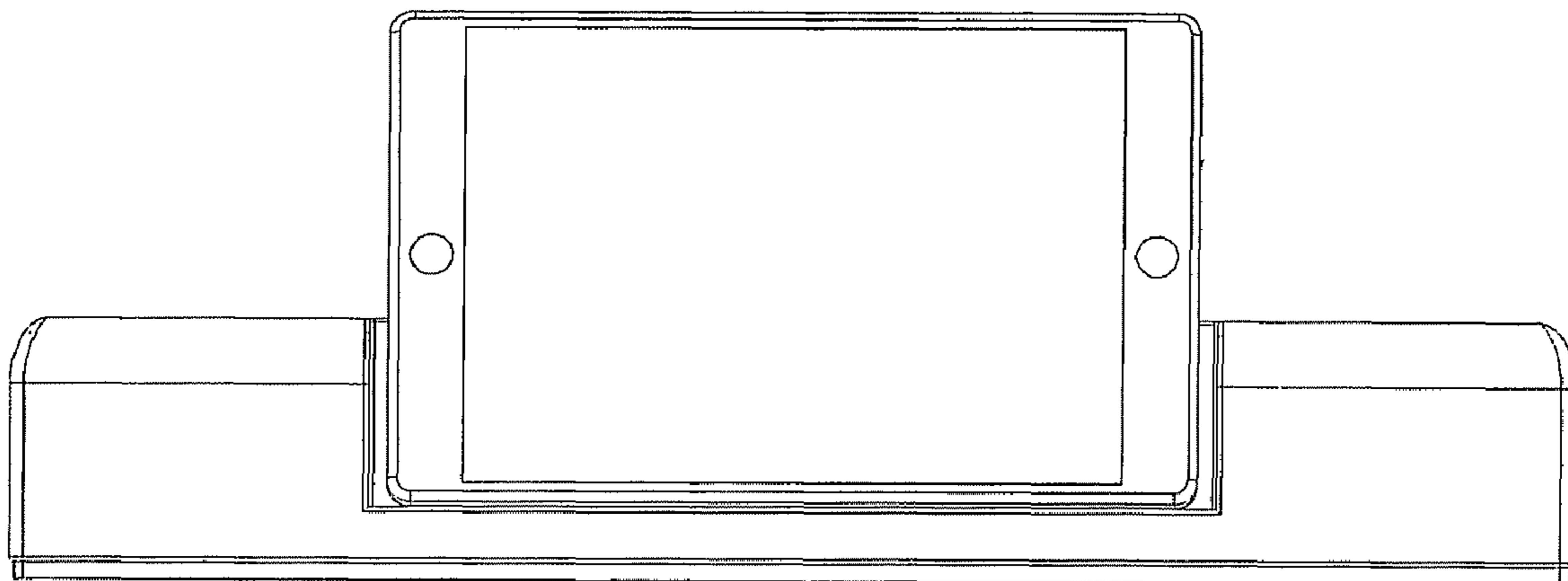

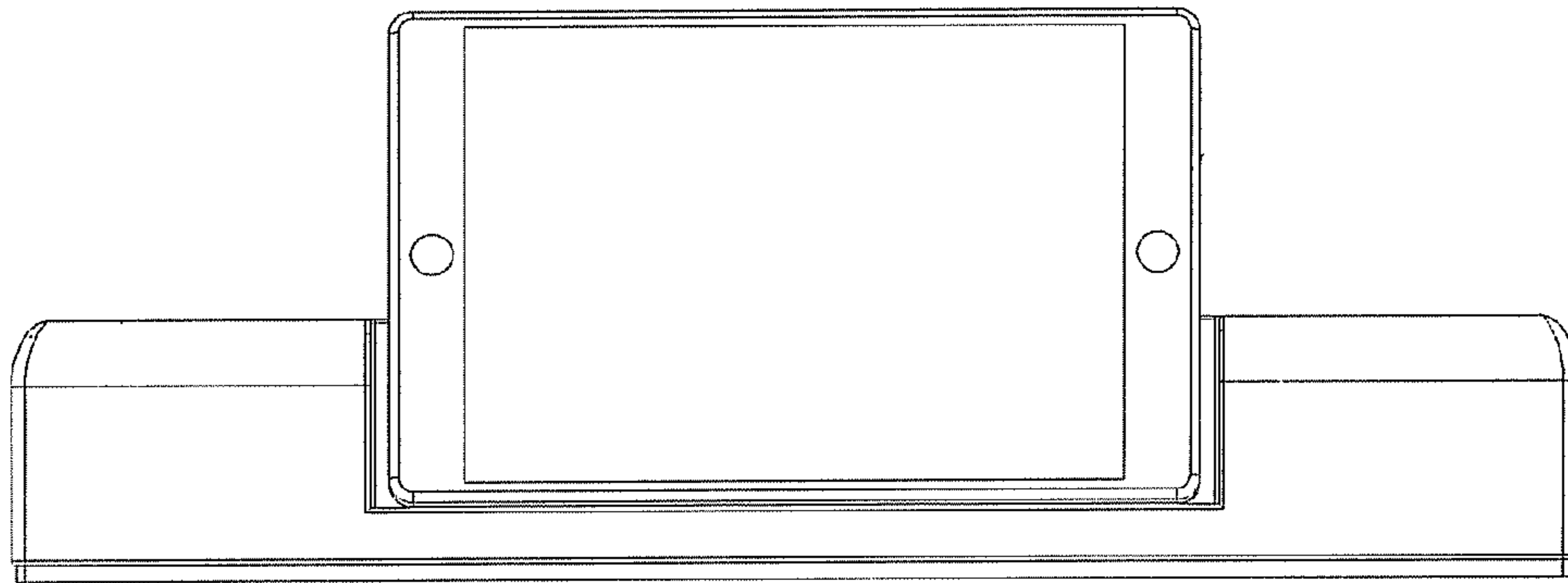

FIG. 1

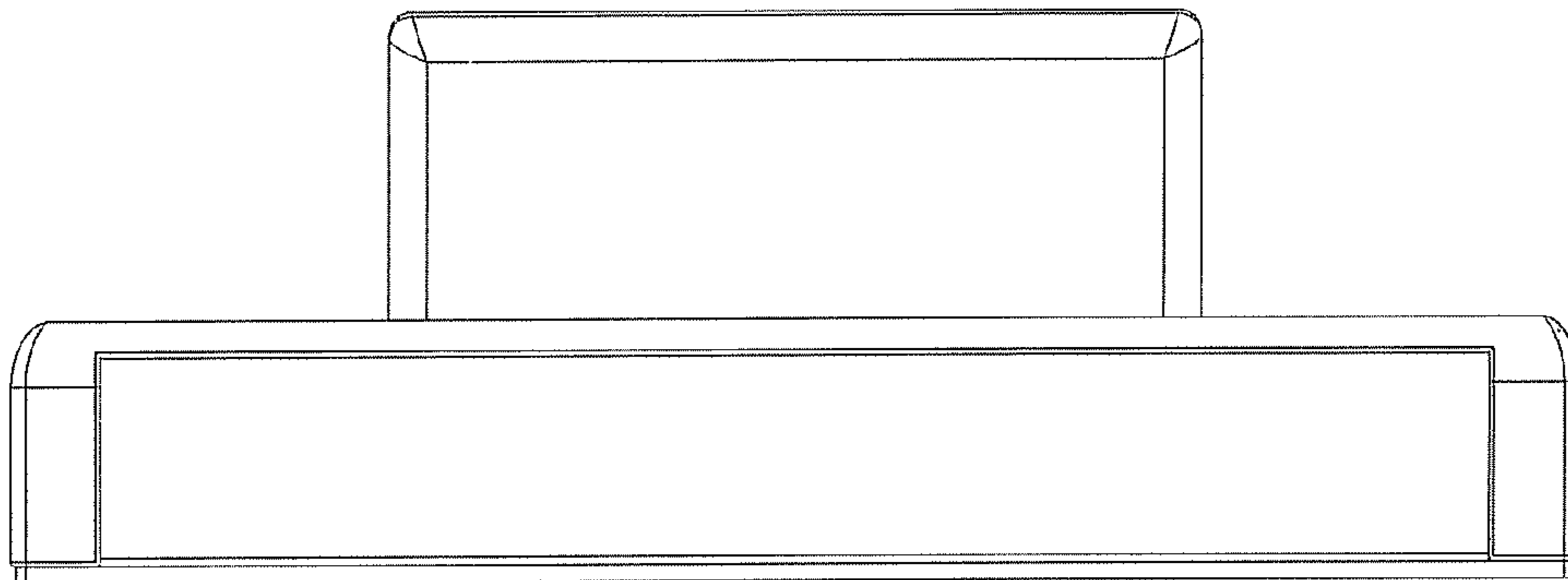

FIG. 2

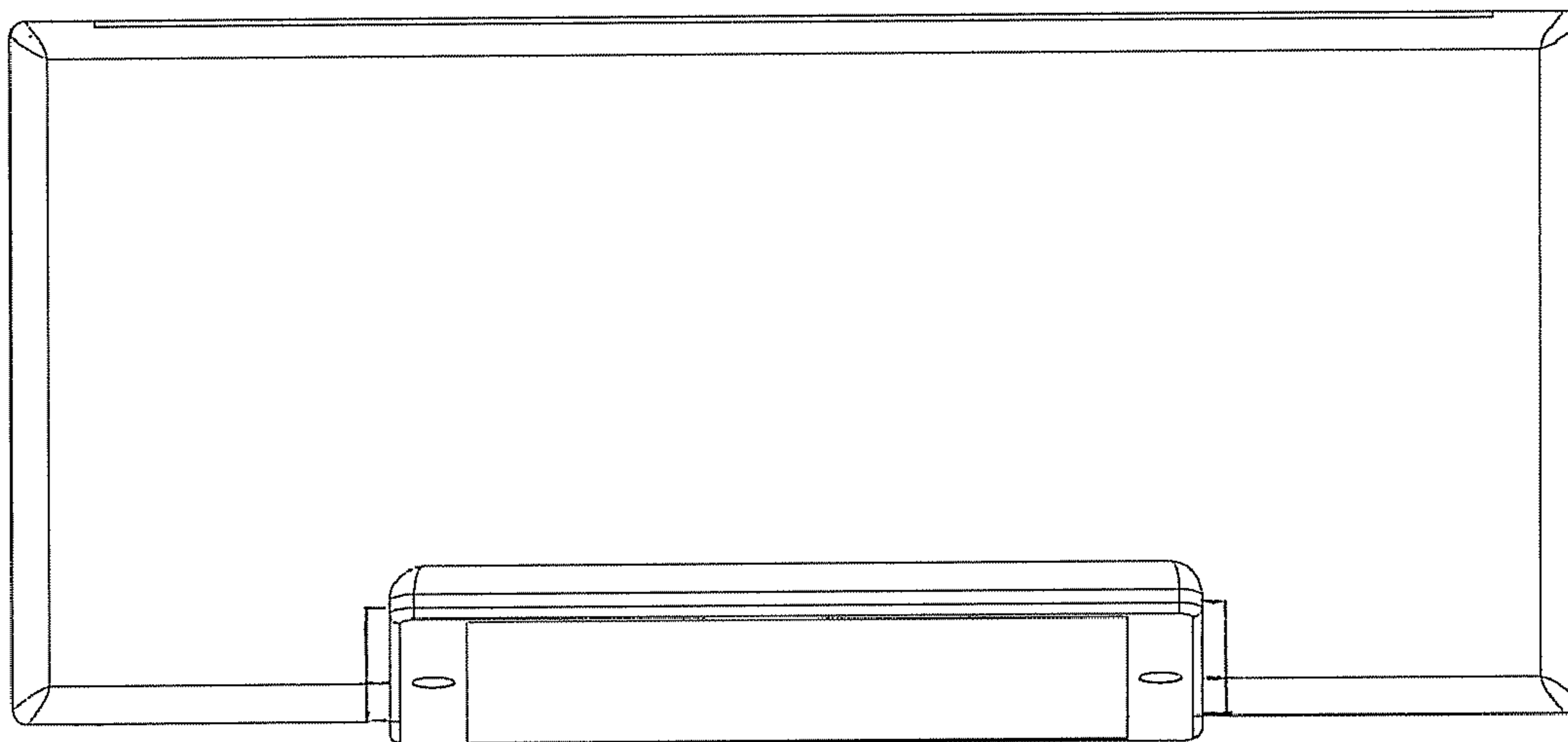

FIG. 3

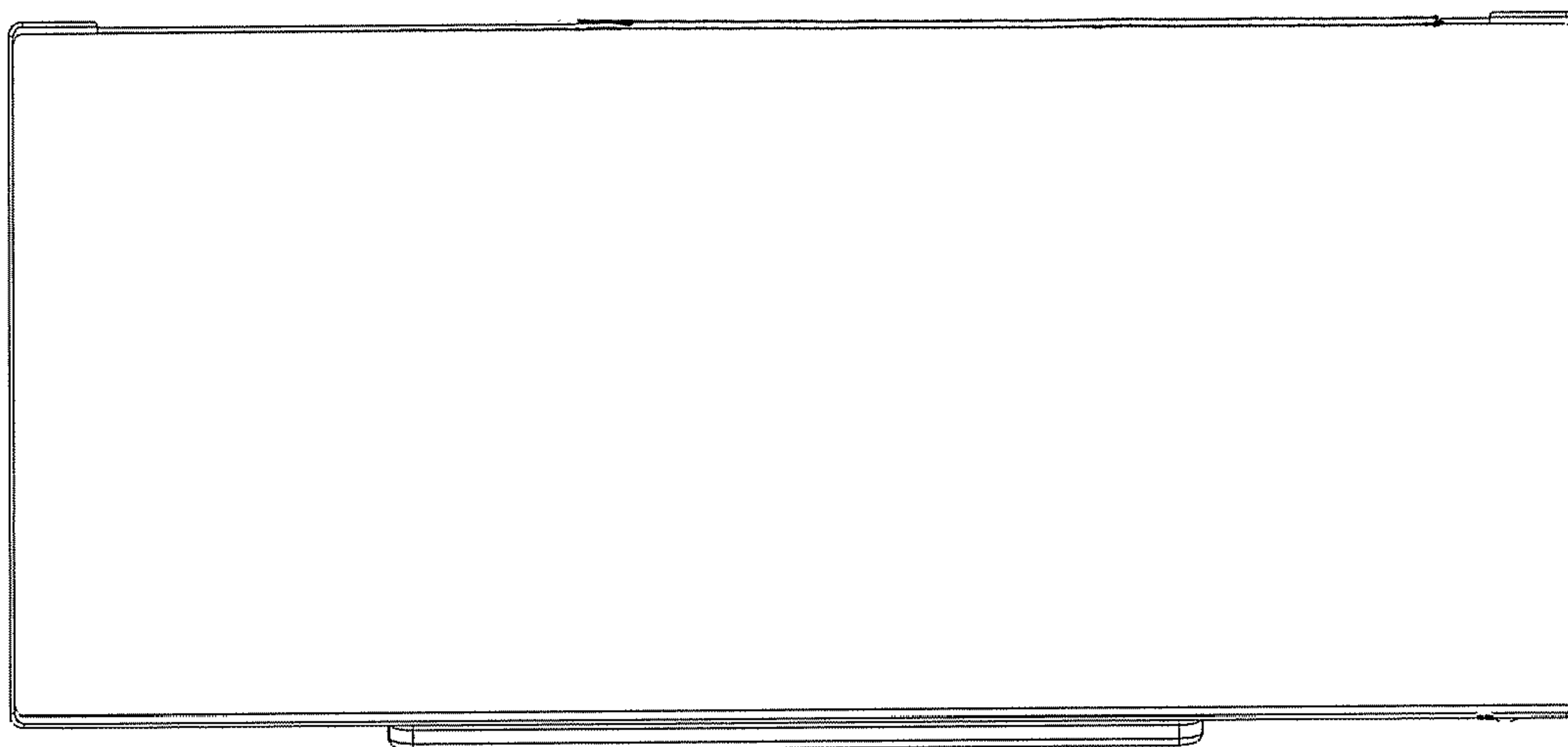

FIG. 4

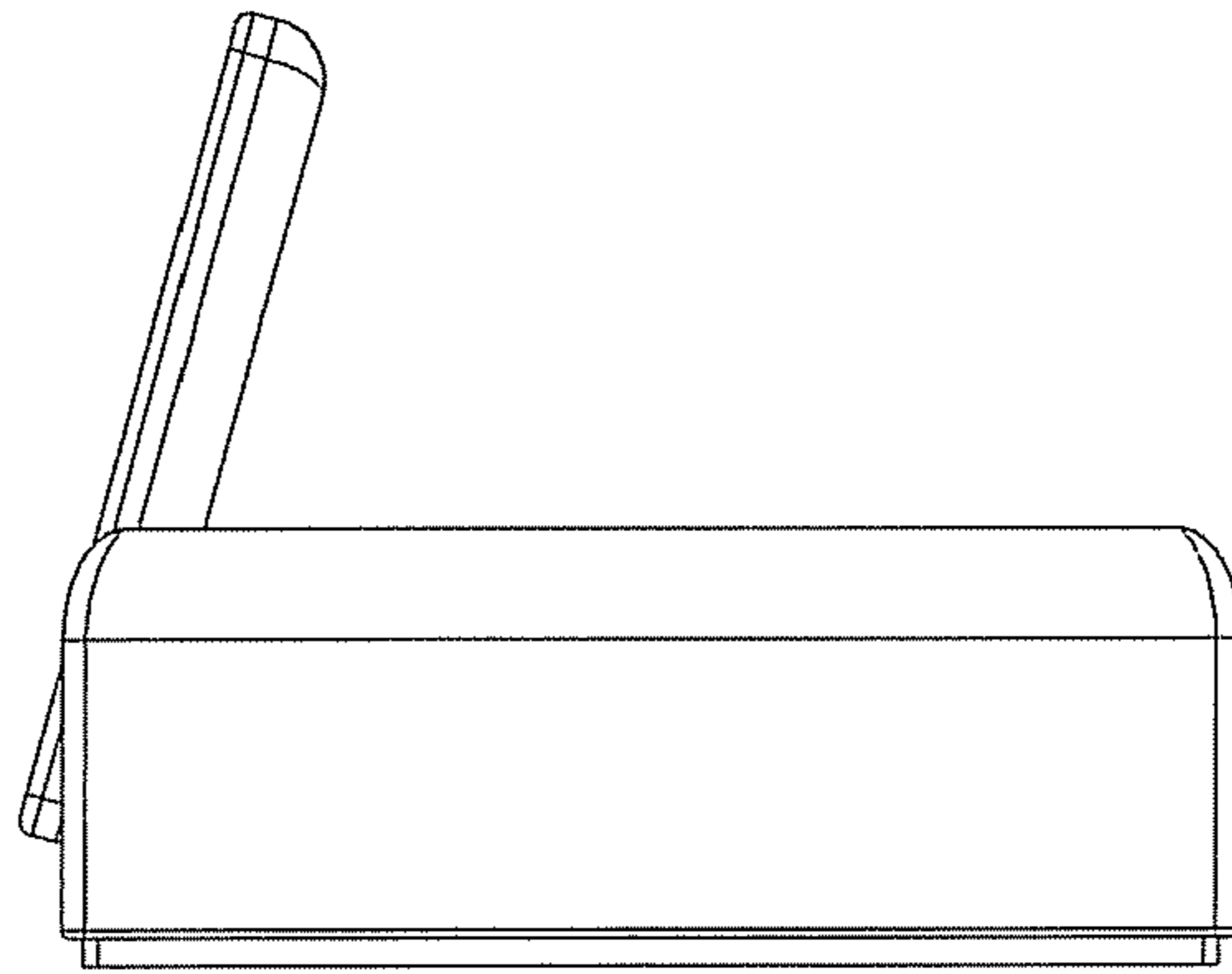

FIG. 5

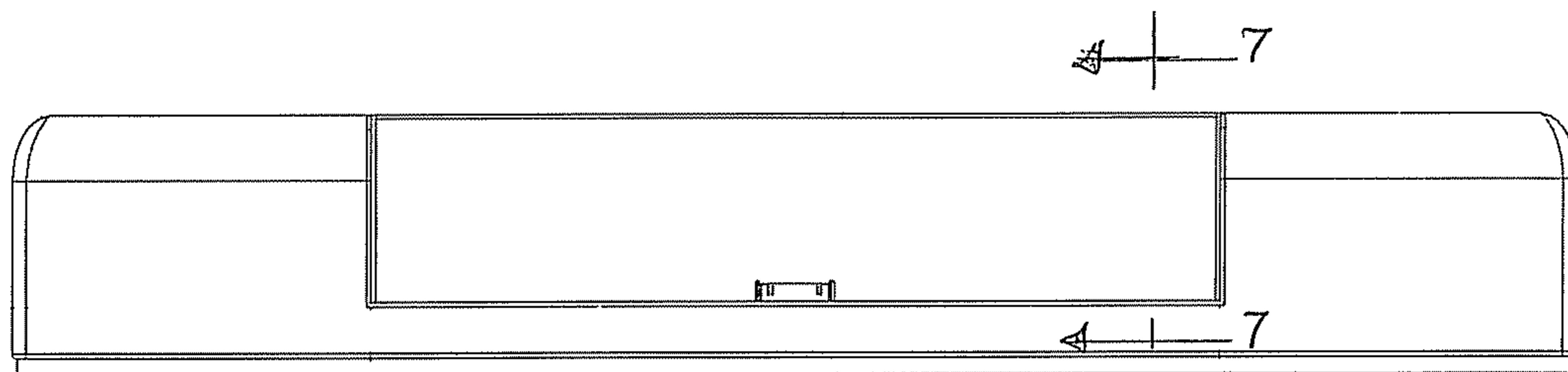

FIG. 6

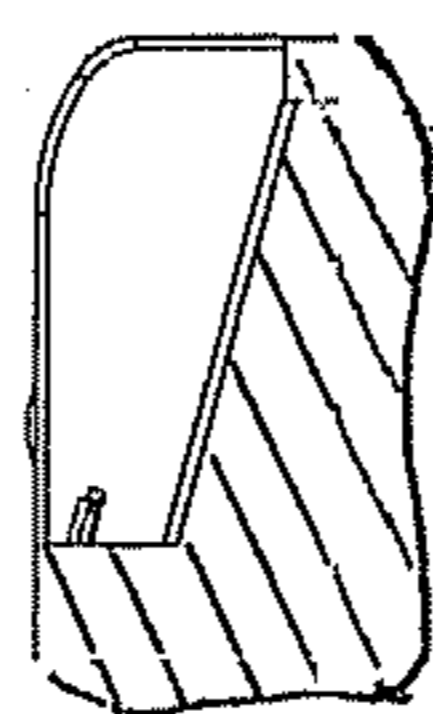

FIG. 7

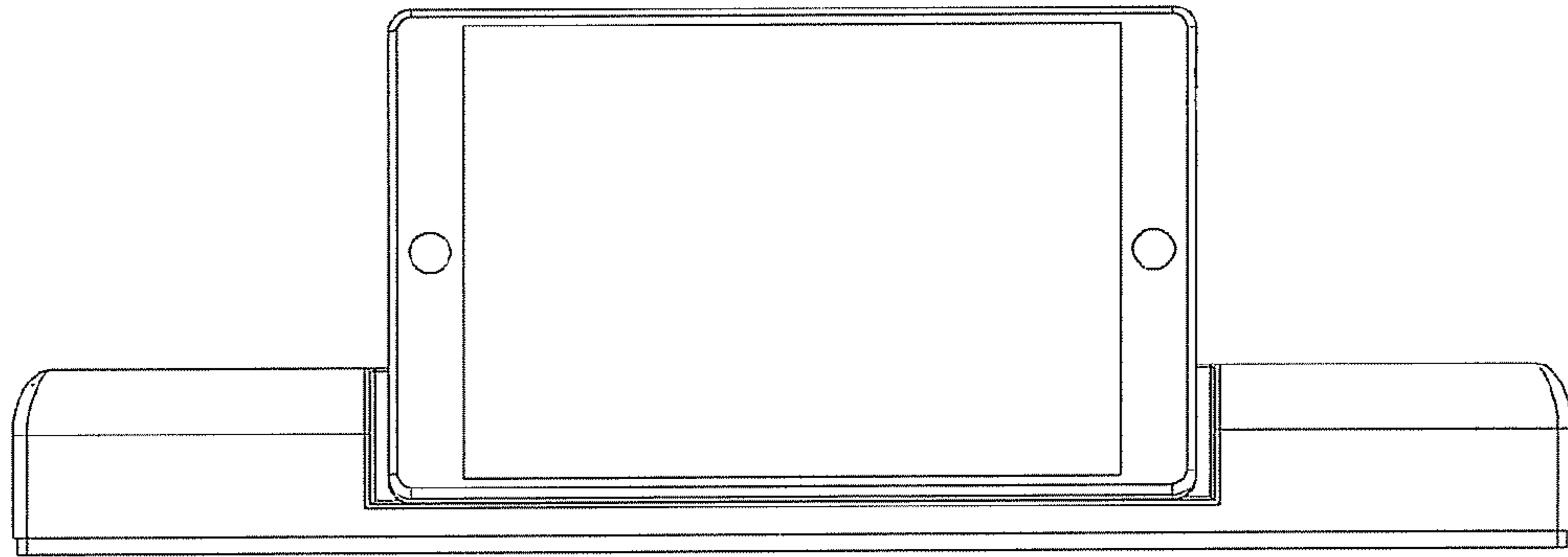

FIG. 8

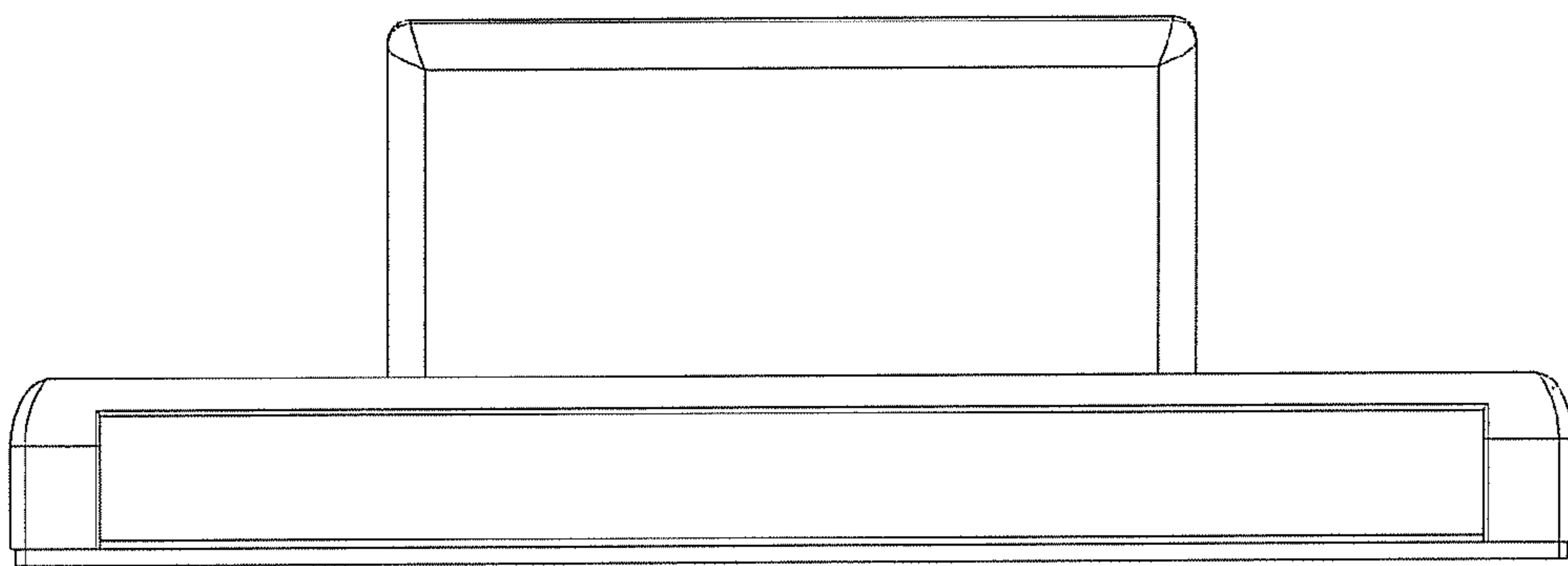

FIG. 9

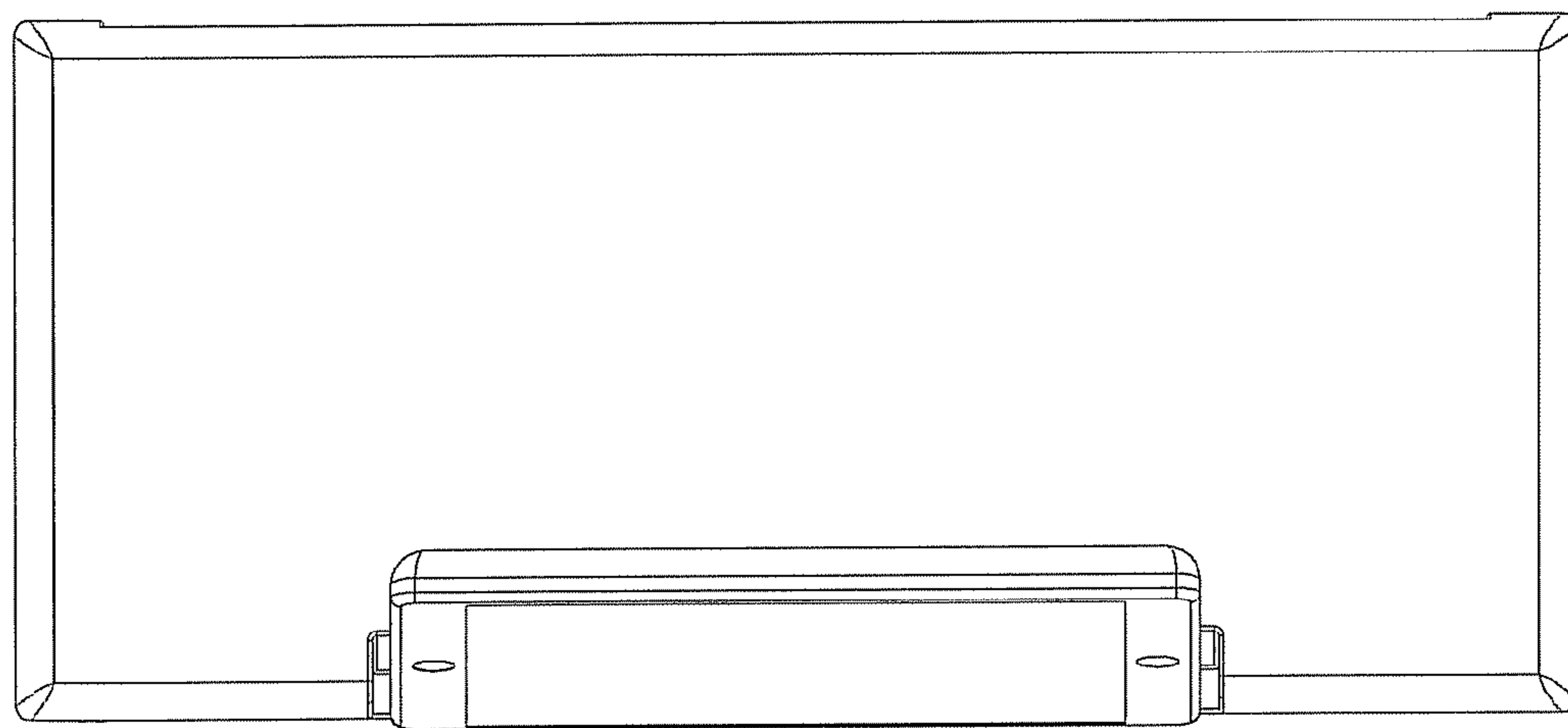

FIG. 10

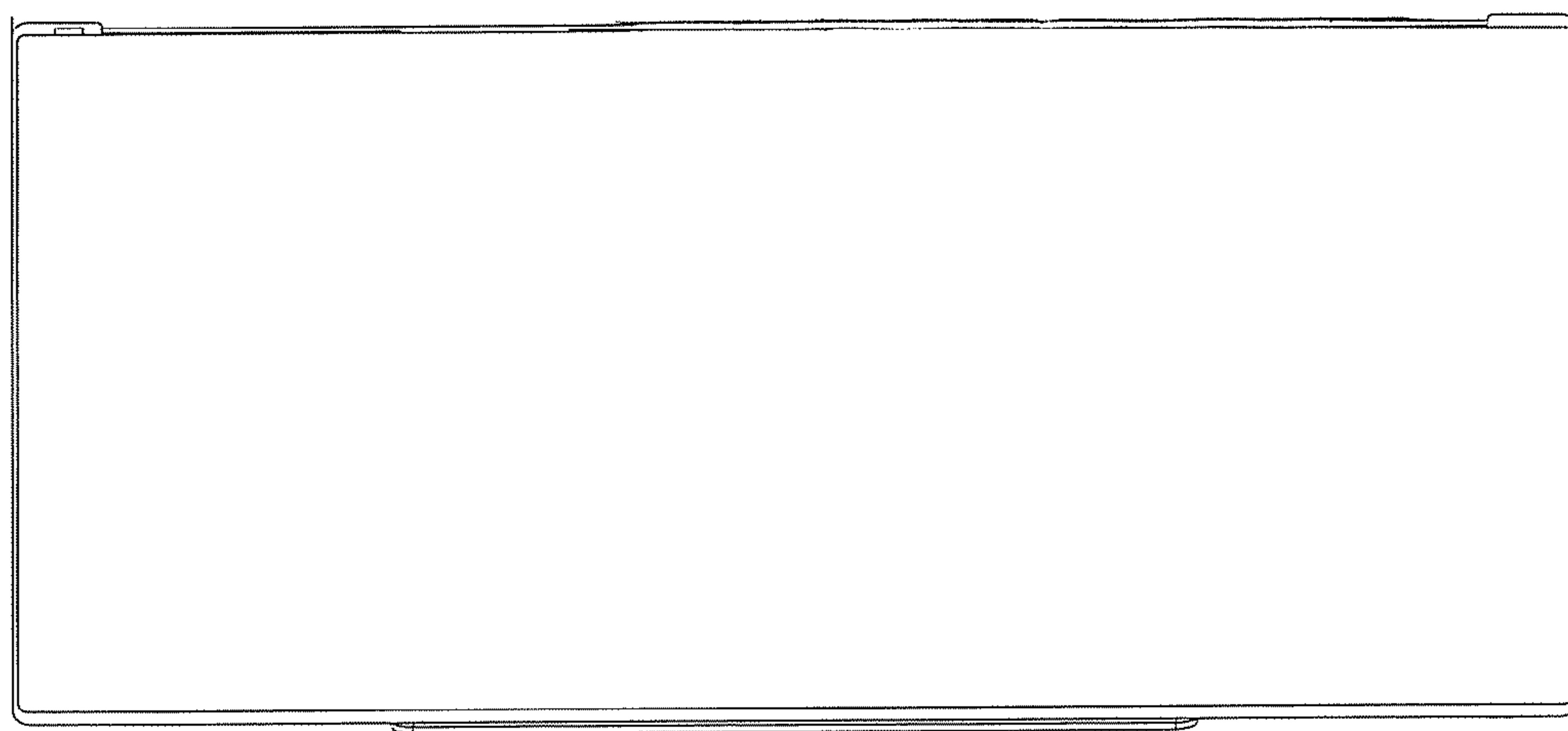

FIG. 11

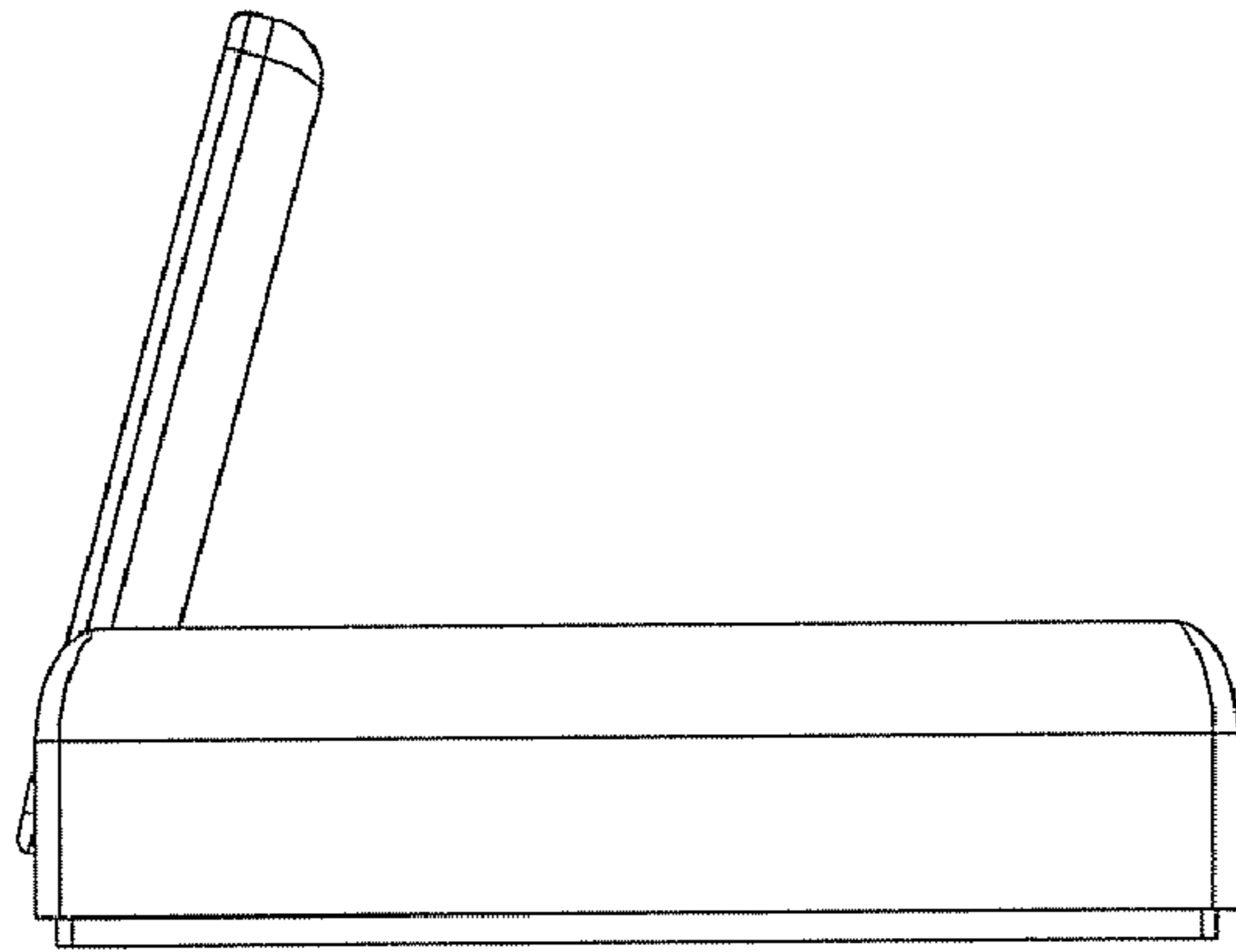

FIG. 12

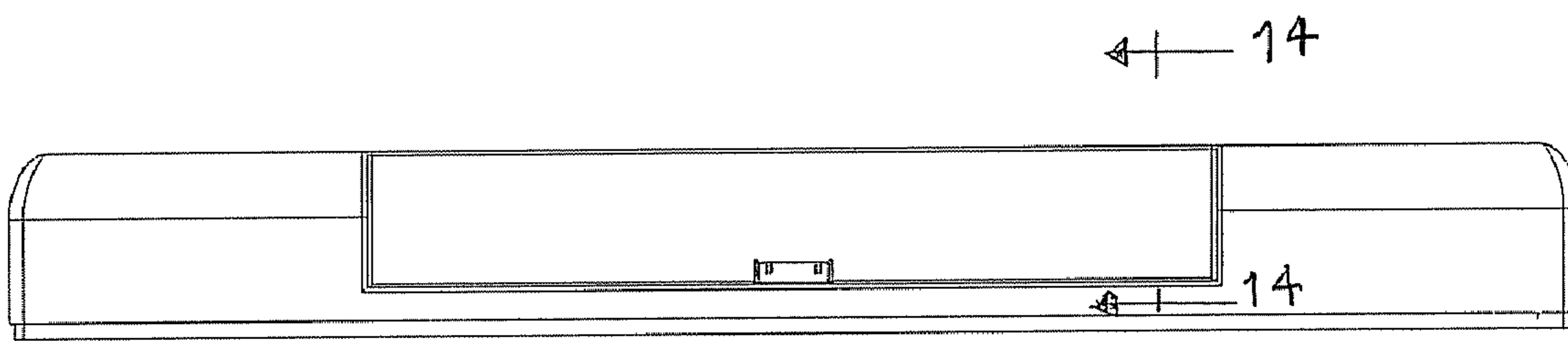

FIG. 13

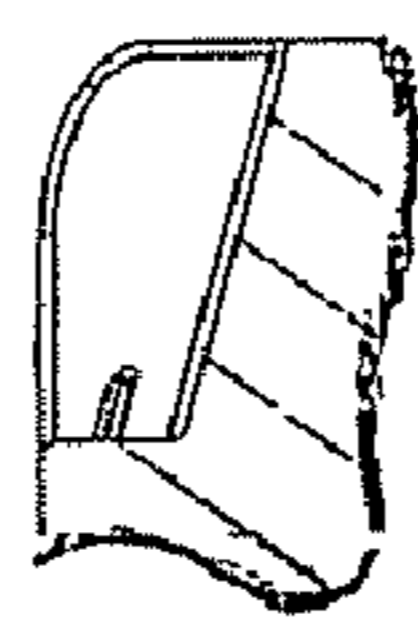

FIG. 14