



US00D650145S

(12) **United States Design Patent**
Farentinos et al.

(10) **Patent No.:** **US D650,145 S**
(45) **Date of Patent:** **** Dec. 6, 2011**

(54) **MAILBOX DOOR**

(75) Inventors: **Christopher Andrew Farentinos**,
Redondo Beach, CA (US); **Vanessa**
Felicia Troyer-Farentinos, Redondo
Beach, CA (US); **Emily Jeanne**
Pearson, Santa Monica, CA (US)

(73) Assignee: **Architectural Mailboxes, LLC**,
Compton, CA (US)

(**) Term: **14 Years**

(21) Appl. No.: **29/386,391**

(22) Filed: **Feb. 28, 2011**

(51) **LOC (9) Cl.** **99-00**

(52) **U.S. Cl.** **D99/43**

(58) **Field of Classification Search** D99/28,
D99/29, 30, 31, 32, 33, 43, 99; D3/272,
D3/294; D6/510; D8/300, 306, 307, 313,
D8/321, 322; 232/1 A, 17, 19, 20, 21, 22,
232/23, 24-31, 34, 35, 37, 38, 39, 44, 45,
232/47

See application file for complete search history.

(56) **References Cited**

U.S. PATENT DOCUMENTS

2,561,007	A *	7/1951	Bierig	232/17
3,815,811	A *	6/1974	Harmon	232/35
4,005,816	A *	2/1977	Malik	232/35
4,244,512	A *	1/1981	Wise	232/17
4,275,829	A *	6/1981	Johnson et al.	232/17
D309,053	S *	7/1990	Shantz	D99/29
4,950,202	A *	8/1990	Florio	446/219
D315,821	S *	3/1991	Lorenzi	D99/29
D332,166	S *	12/1992	Williams	D99/29
D332,341	S	1/1993	Mayfield	
D360,741	S *	7/1995	Bohlmann	D99/30
5,449,111	A *	9/1995	Sauzedde et al.	232/17
D445,988	S *	7/2001	Gaines et al.	D99/29

D499,225	S *	11/2004	Taylor et al.	D99/32
D501,594	S *	2/2005	Taylor et al.	D99/29
D503,504	S *	3/2005	Taylor et al.	D99/29
D503,843	S *	4/2005	Murphy et al.	D99/30
D514,270	S *	1/2006	Lackey et al.	D99/30
D517,270	S *	3/2006	Lackey et al.	D99/30
7,090,119	B1 *	8/2006	Lackey et al.	232/45
7,252,221	B1 *	8/2007	Bowers	232/45
D563,625	S	3/2008	Bowers	
D580,623	S *	11/2008	Bowers	D99/29
D580,624	S *	11/2008	Bowers	D99/29
7,527,190	B1 *	5/2009	Bowers et al.	232/45

OTHER PUBLICATIONS

Brick Mailbox Doors, <http://www.betterboxmailboxes.com/brick-mailboxes-doors.php>, by Better Box Mailboxes, copyright 2011.*
Gladiator Mailbox, <http://www.luxuryhousingtrends.com/archive/2008/10/gladiator-mailbox.com>, by Luxury Housing Trends, copyright 2005-2010.*

* cited by examiner

Primary Examiner — Elizabeth J Oswecki

(74) *Attorney, Agent, or Firm* — Vista IP Law Group LLP

(57) **CLAIM**

The ornamental design for the mailbox door, as shown and described.

DESCRIPTION

FIG. 1 is a front perspective view of a mailbox door showing our new design;
FIG. 2 is a front view thereof;
FIG. 3 is a back view thereof;
FIG. 4 is a right side view thereof, the left side being identical;
FIG. 5 is a top plan view thereof; and,
FIG. 6 is a bottom plan view thereof.
The dotted lines in the drawings form no part of the claimed design, but are shown to help illustrate an environment in which the claimed design may be used.

1 Claim, 2 Drawing Sheets

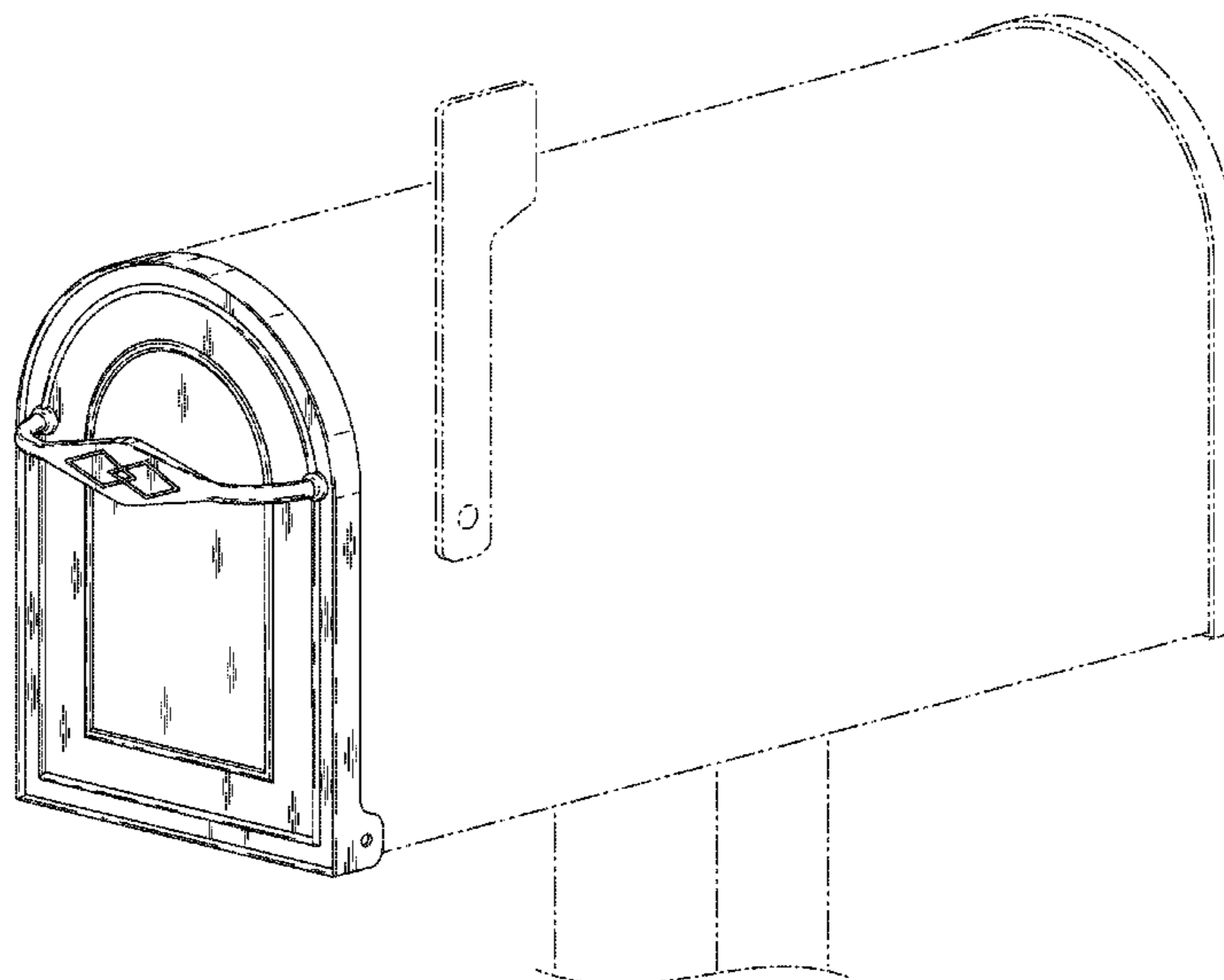

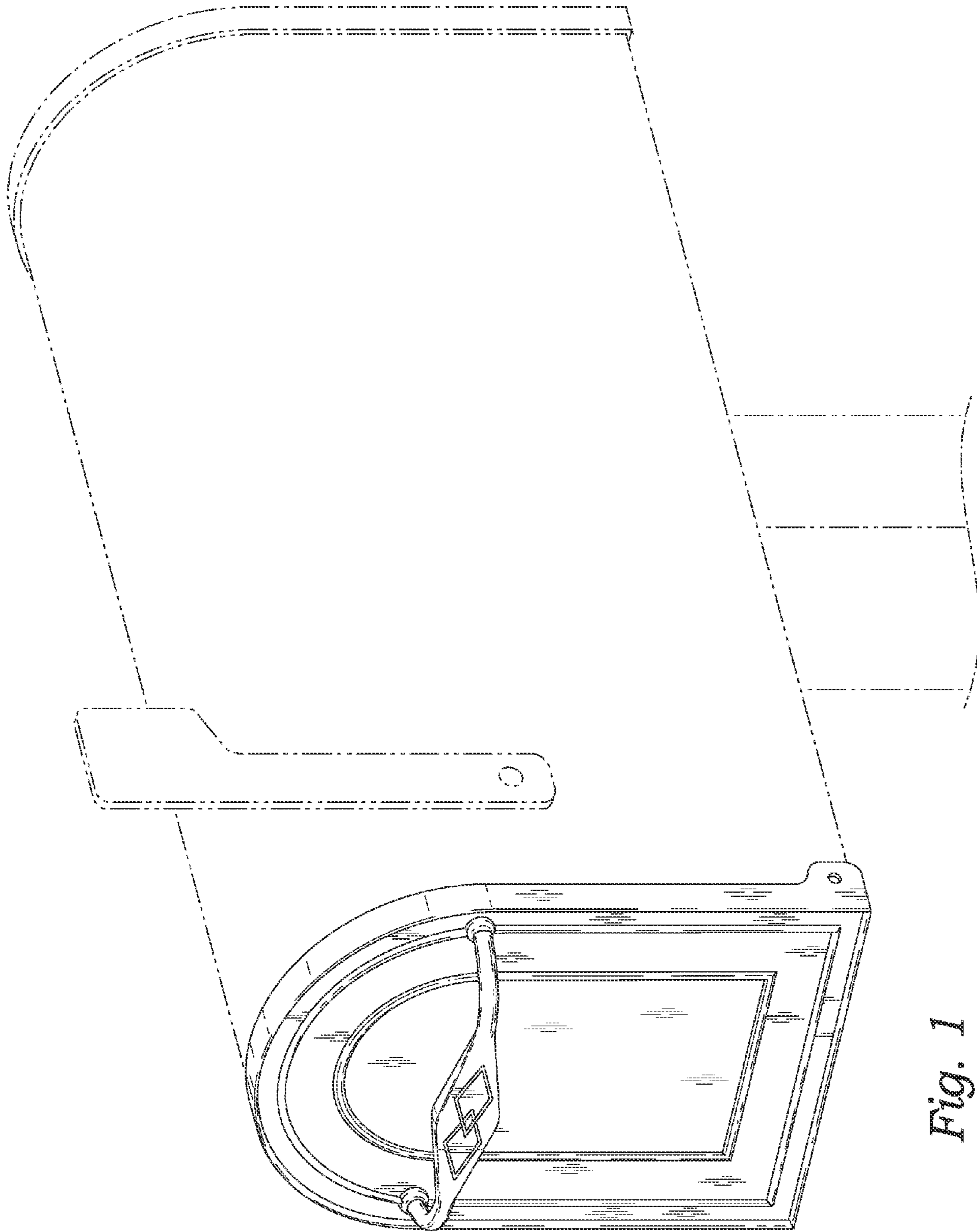

Fig. 1

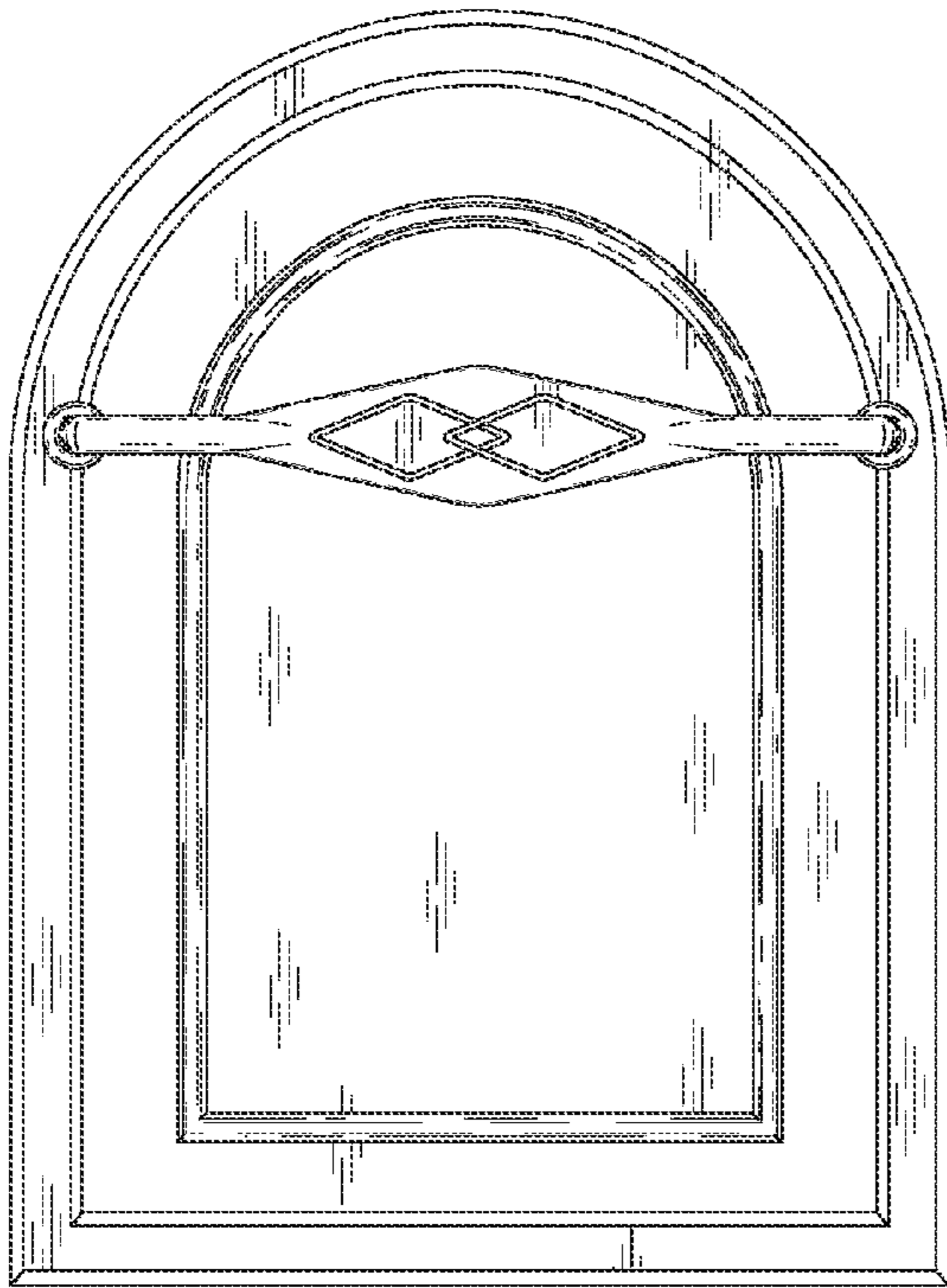

Fig. 2

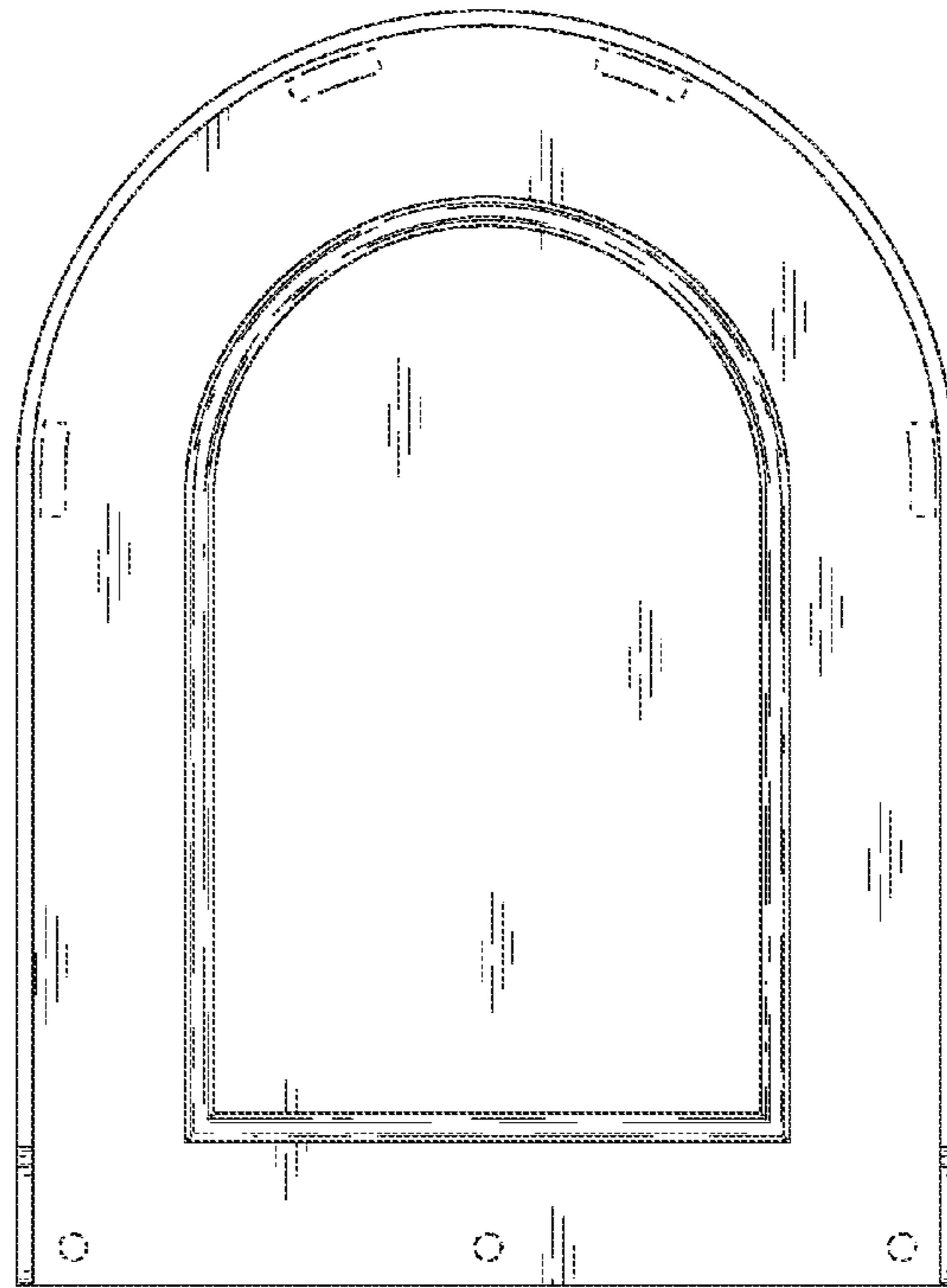

Fig. 3

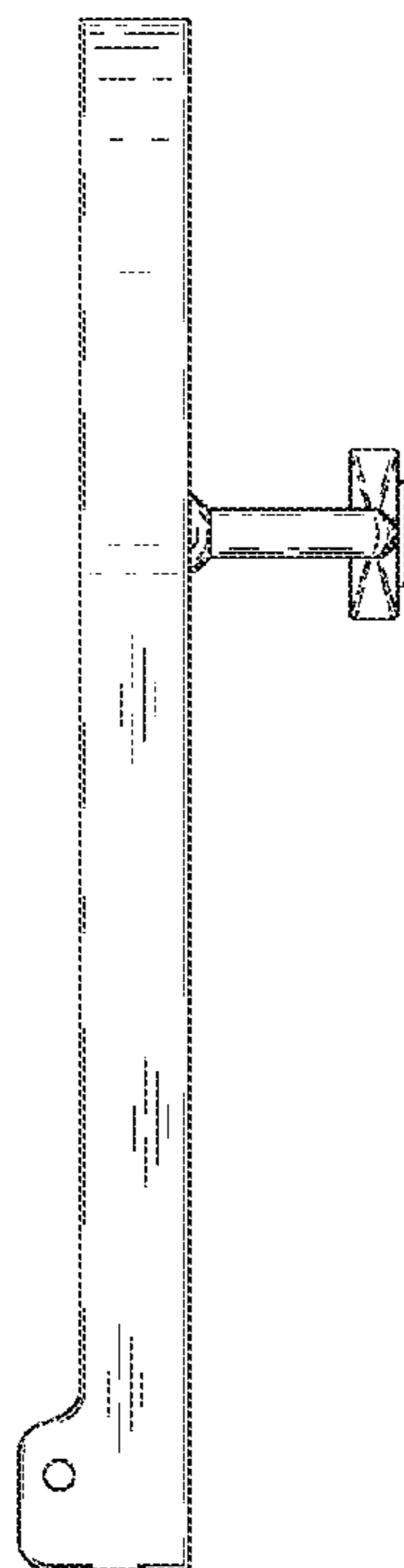

Fig. 4

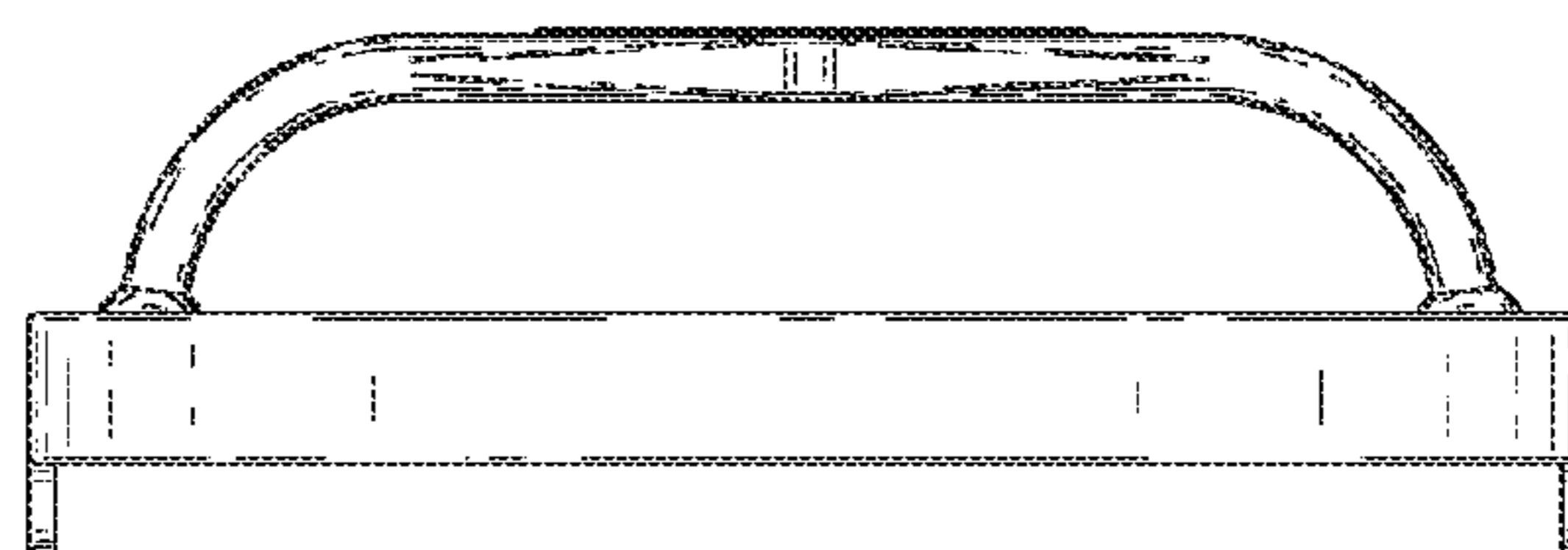

Fig. 5

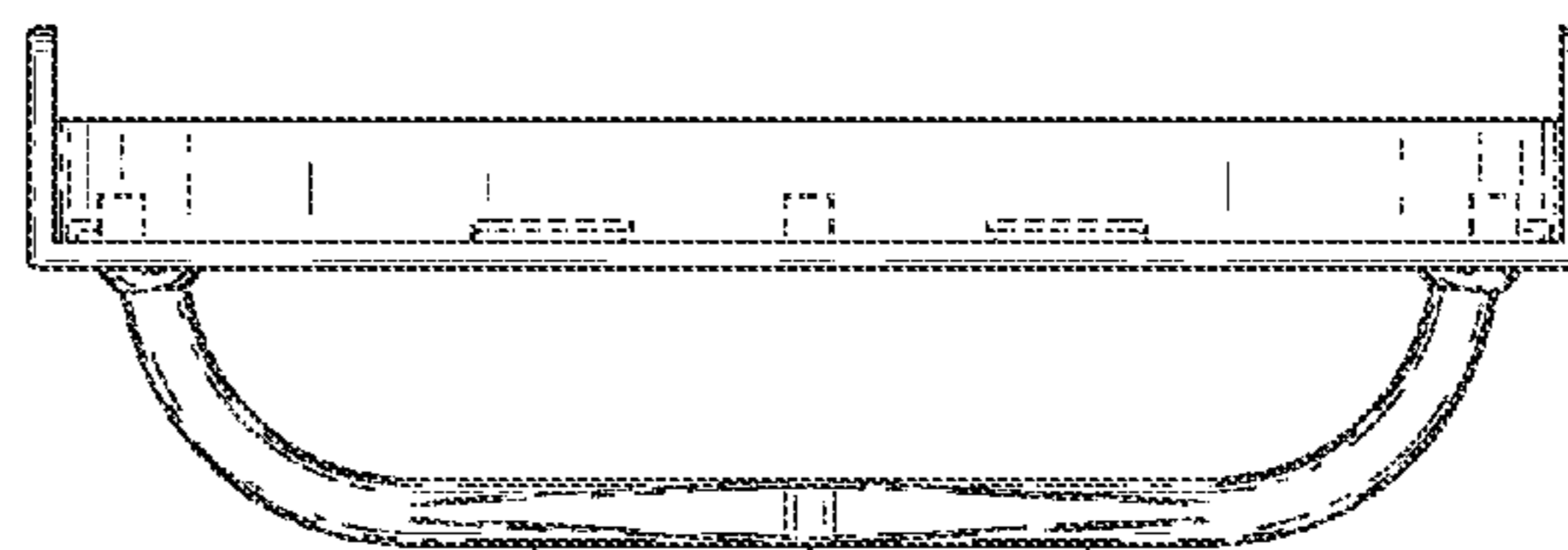

Fig. 6