



US00D650101S

(12) **United States Design Patent**
Velez et al.

(10) **Patent No.:** **US D650,101 S**

(45) **Date of Patent:** **** Dec. 6, 2011**

(54) **LIGHTING DEVICE**

(76) Inventors: **Jason Velez**, Bronx, NY (US); **Birakoye Nassoko**, Bronx, NY (US)

(**) Term: **14 Years**

(21) Appl. No.: **29/328,250**

(22) Filed: **Nov. 20, 2008**

(51) **LOC (9) Cl.** **26-02**

(52) **U.S. Cl.** **D26/37**

(58) **Field of Classification Search** D26/37,
D26/38, 51, 43, 44, 48, 24, 63, 61, 29; 362/278–282,
362/285, 287, 288, 418, 427–429, 546, 547

See application file for complete search history.

(56) **References Cited**

U.S. PATENT DOCUMENTS

2,516,270	A *	7/1950	Swain	40/361
D339,649	S *	9/1993	Klossner	D26/63
D391,382	S *	2/1998	Rahn	D26/63
D441,889	S *	5/2001	Austin	D26/63
6,513,952	B1 *	2/2003	Johnson et al.	362/282
D500,528	S *	1/2005	Morris et al.	D21/324
D536,811	S *	2/2007	Stekelenburg	D26/37
D550,385	S *	9/2007	Hamilton et al.	D26/37
D553,771	S *	10/2007	Watson et al.	D26/37
D570,024	S *	5/2008	Guercio	D26/63

7,537,366	B2 *	5/2009	Inoue et al.	362/547
D597,693	S *	8/2009	Kauffman et al.	D26/63
D625,870	S *	10/2010	Feigenbaum	D26/63
D629,550	S *	12/2010	Sandell	D26/63
2004/0228133	A1 *	11/2004	Tsao	362/418

* cited by examiner

Primary Examiner — Ian Simmons

Assistant Examiner — Carissa C Fitts

(74) *Attorney, Agent, or Firm* — Kenyon & Kenyon LLP

(57) **CLAIM**

The ornamental design for a lighting device, as shown and described.

DESCRIPTION

FIG. 1 is a front perspective view of an embodiment of a lighting device showing my new design; FIG. 2 is a rear perspective view thereof; FIG. 3 is a front view thereof; FIG. 4 is a rear view thereof; FIG. 5 is a top view thereof; FIG. 6 is a bottom view thereof; FIG. 7 is a left side view thereof; and, FIG. 8 is a right side view thereof.

The broken line portions shown in FIGS. 1 to 8 are for illustrative purposes only and form no part of the claimed design.

1 Claim, 8 Drawing Sheets

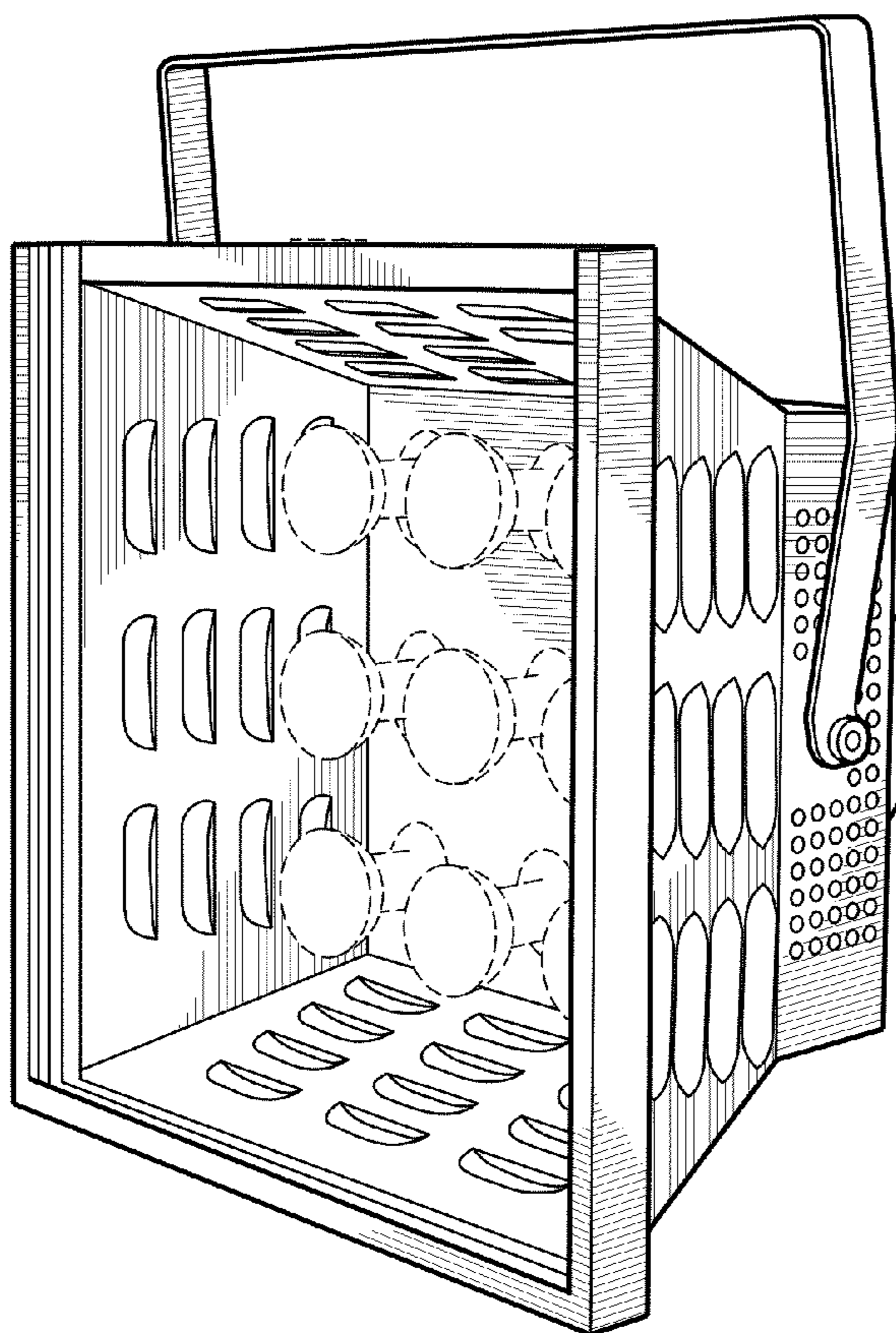

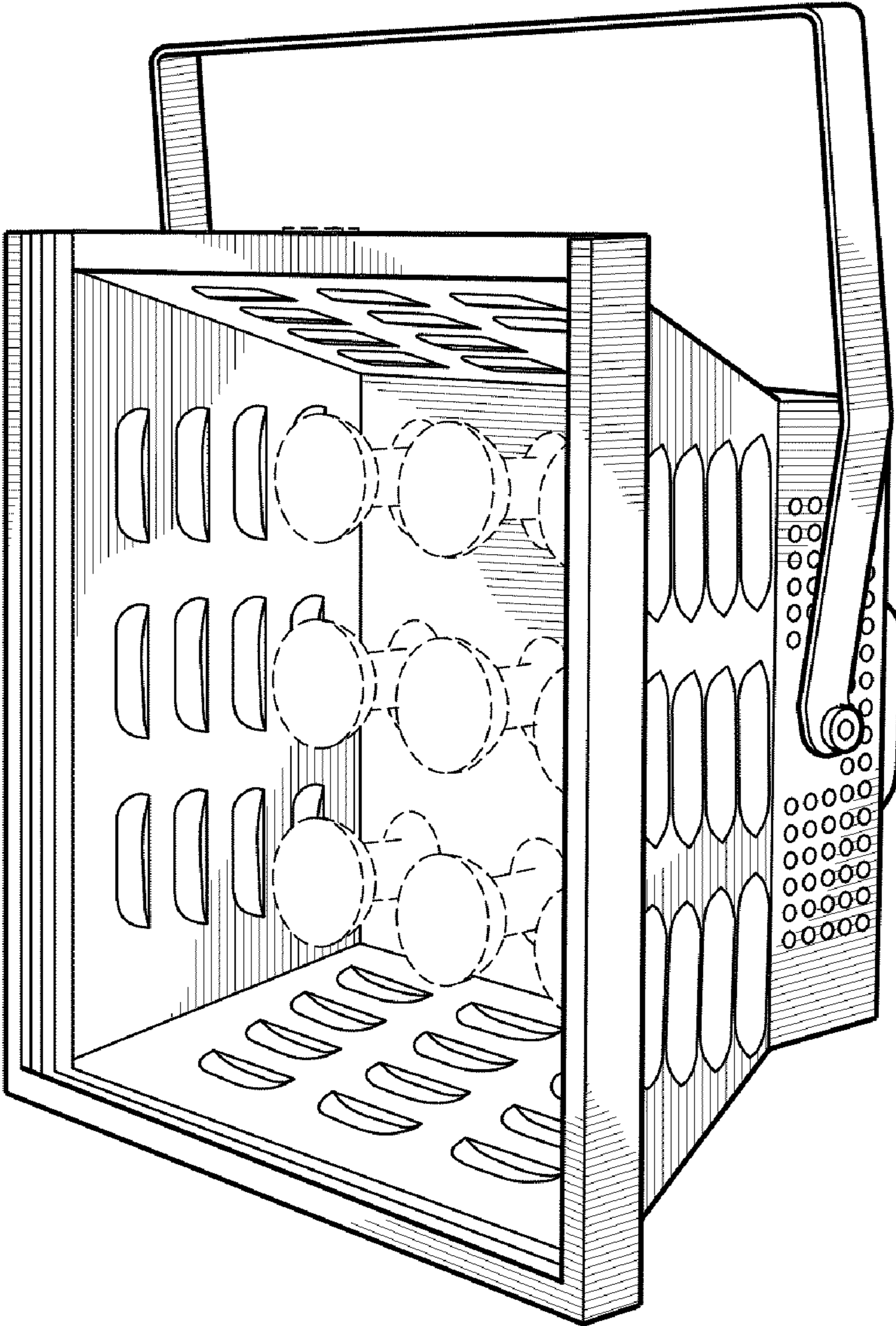

FIG. 1

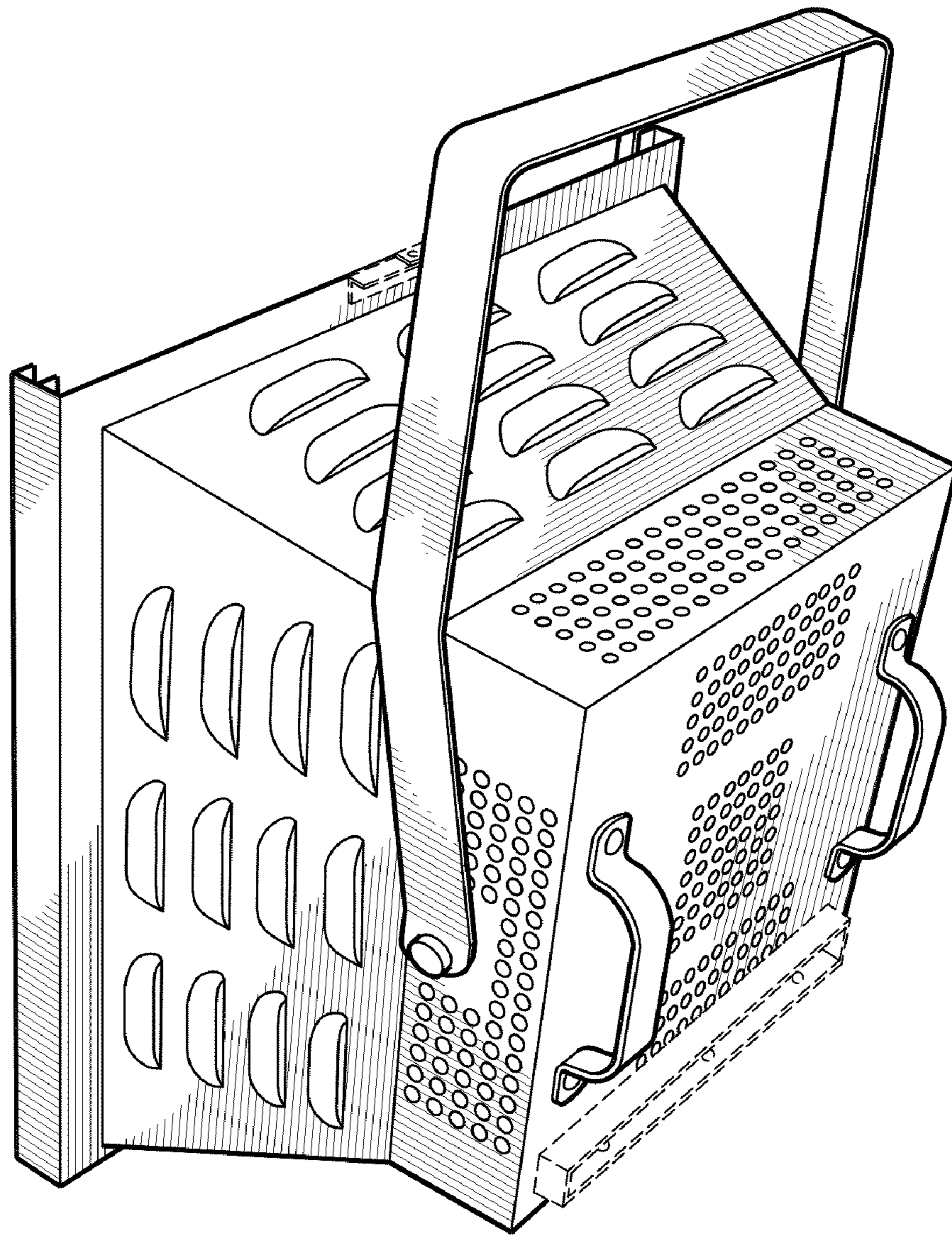

FIG. 2

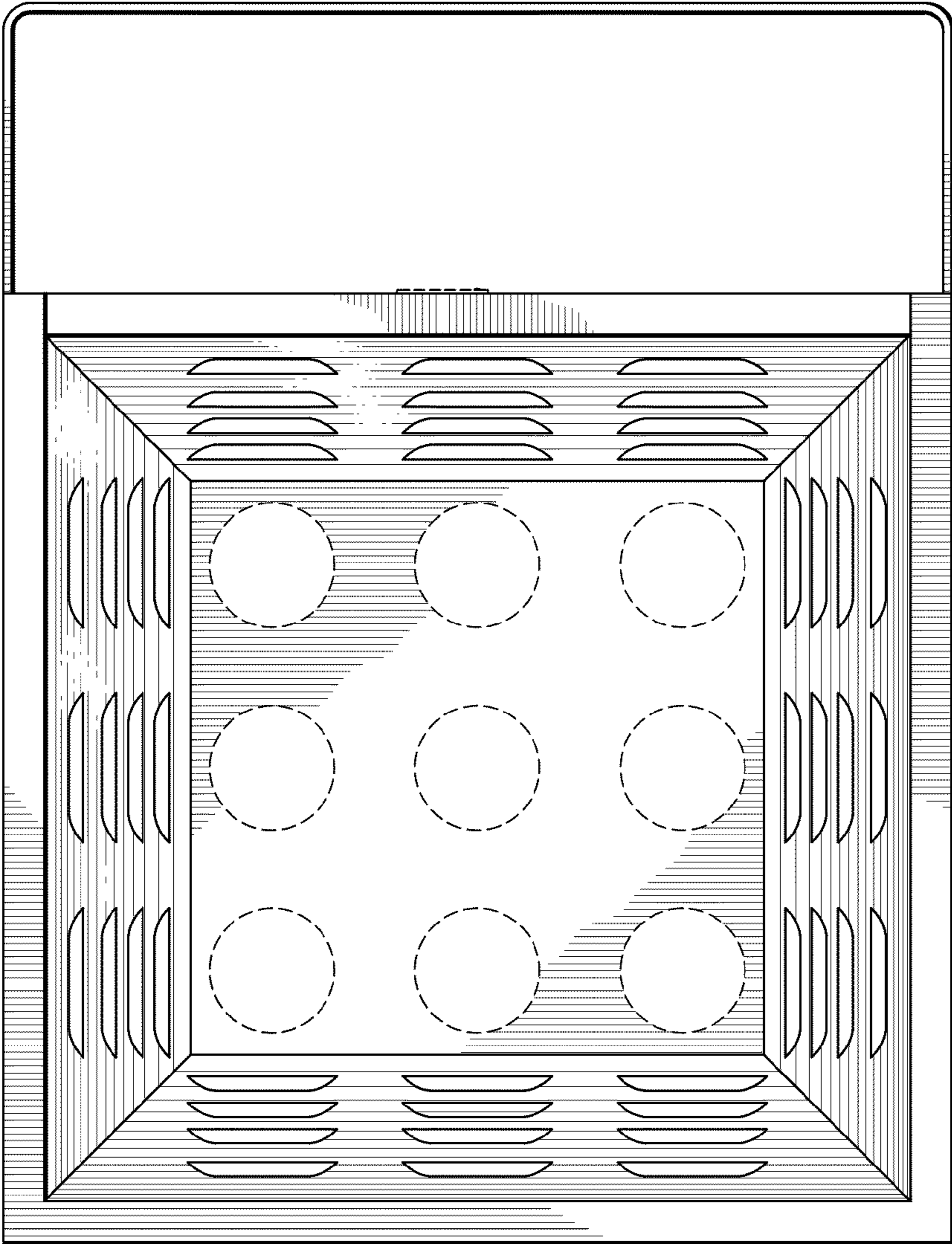

FIG. 3

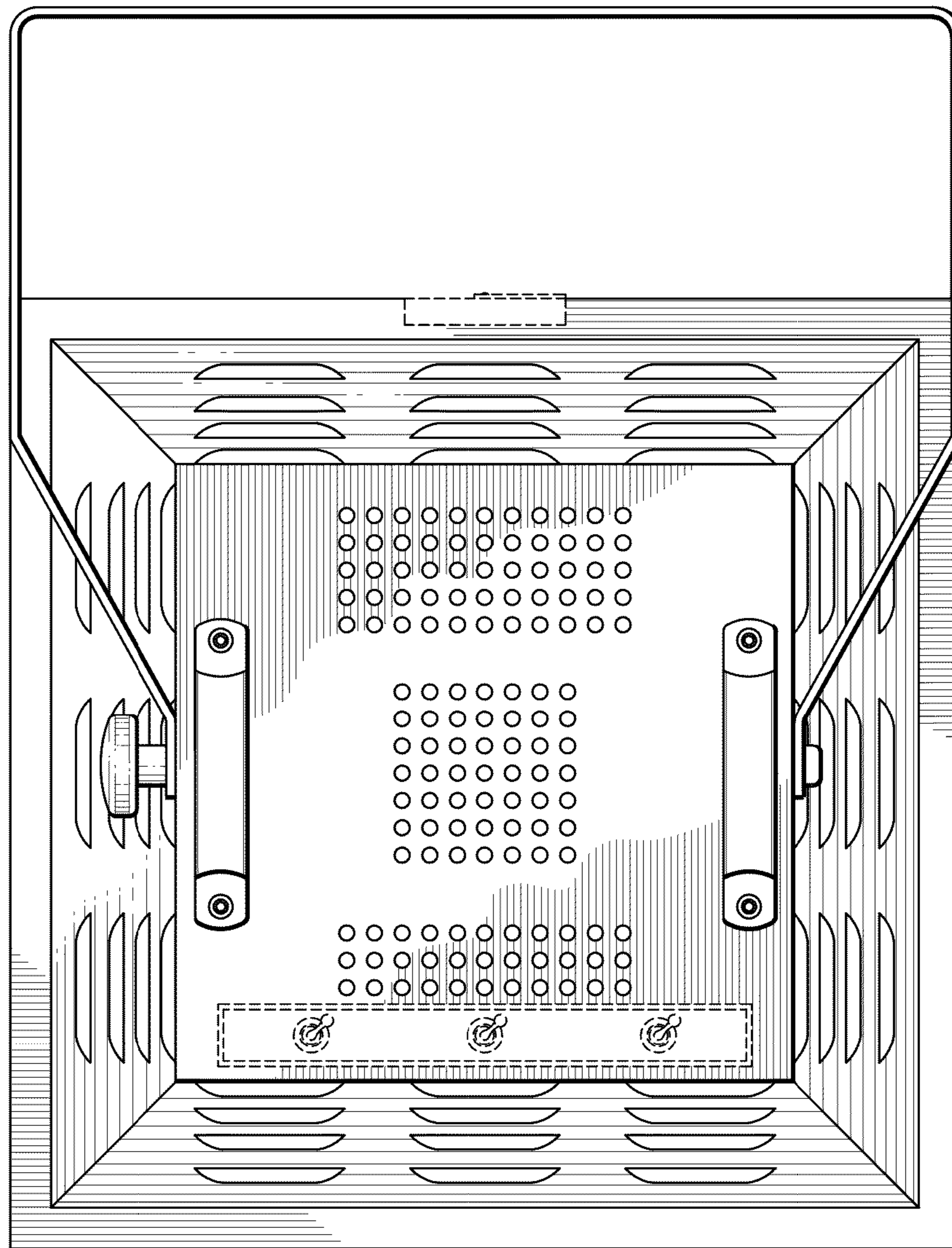

FIG. 4

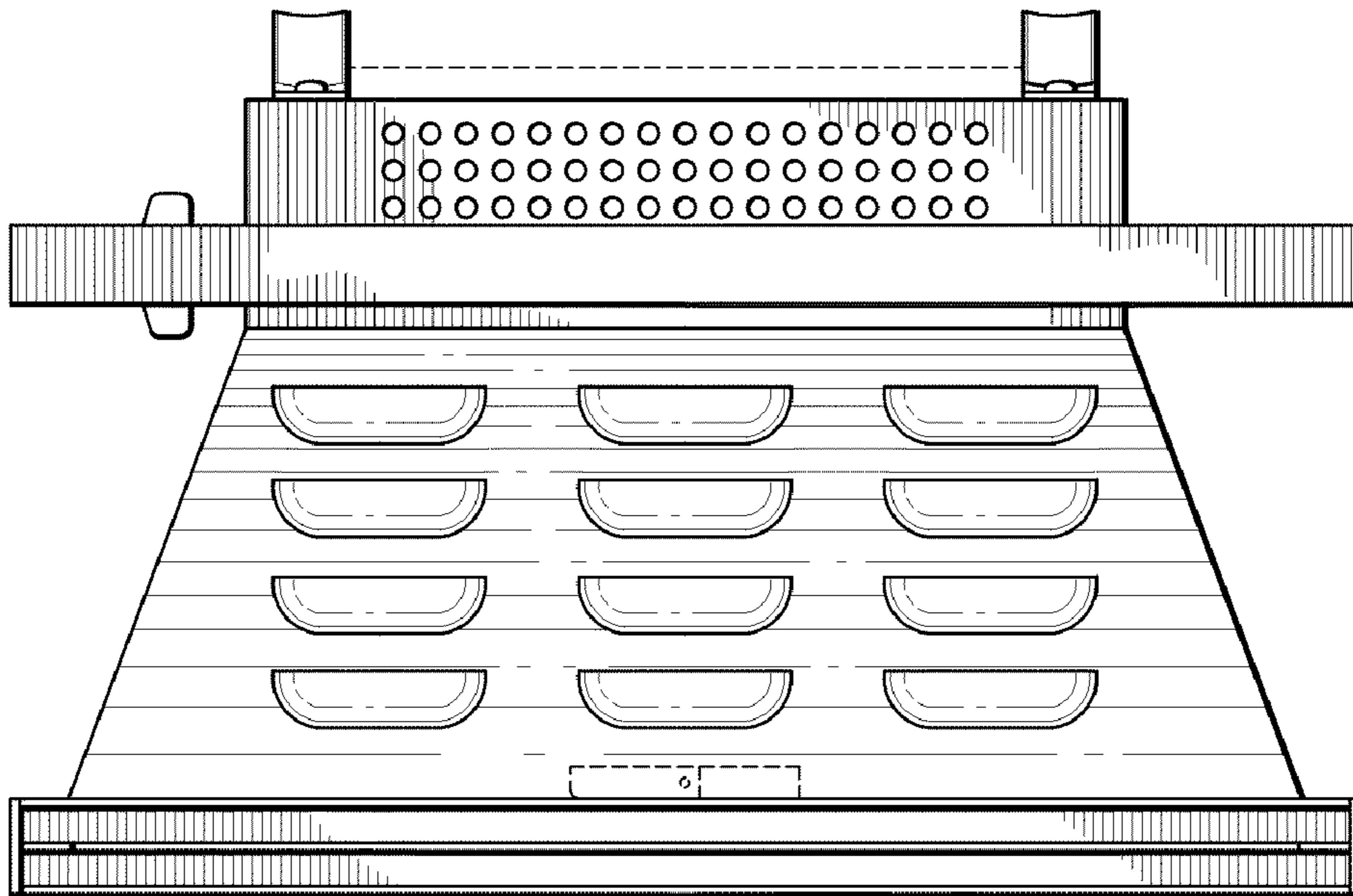

FIG. 5

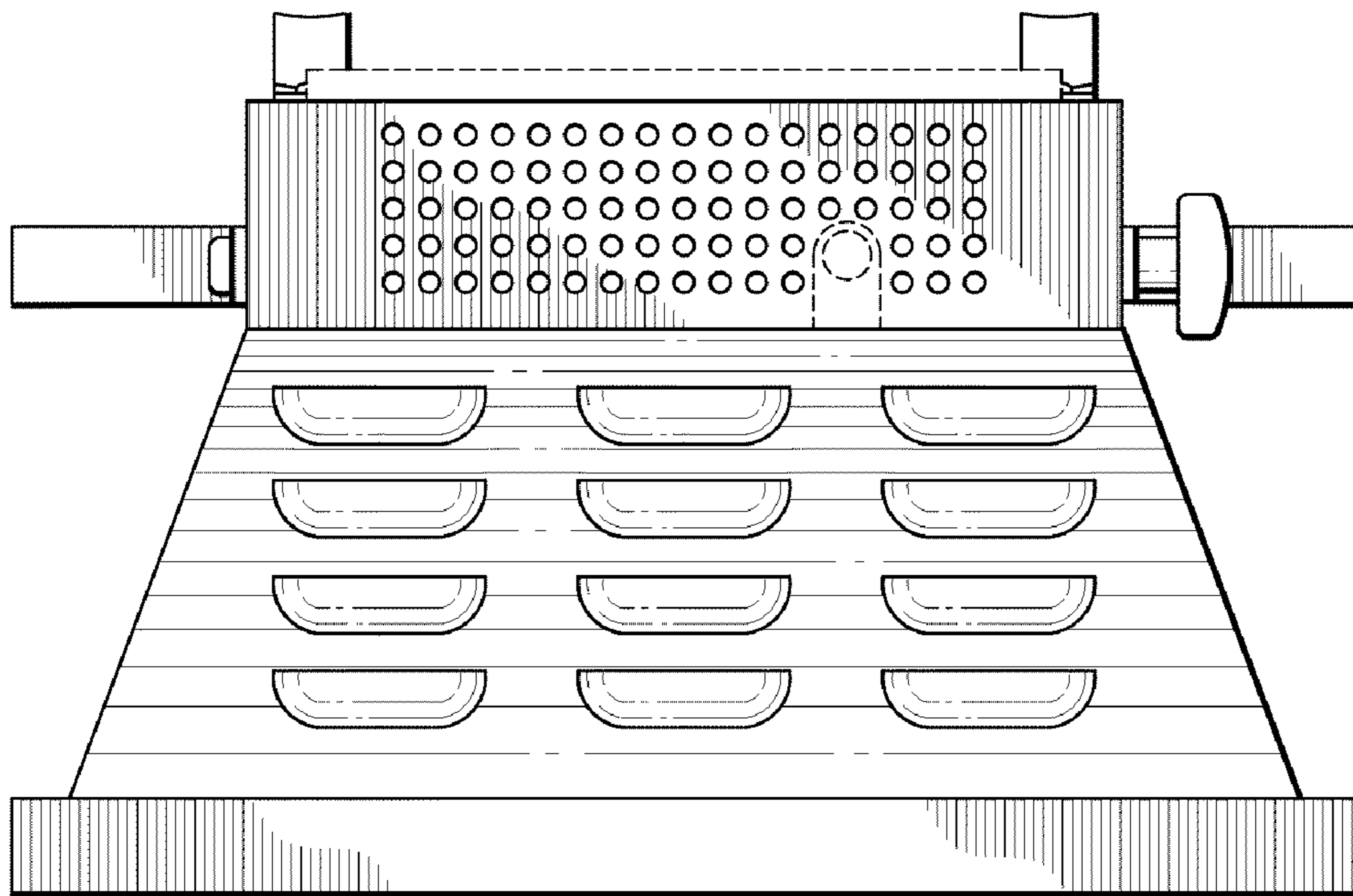

FIG. 6

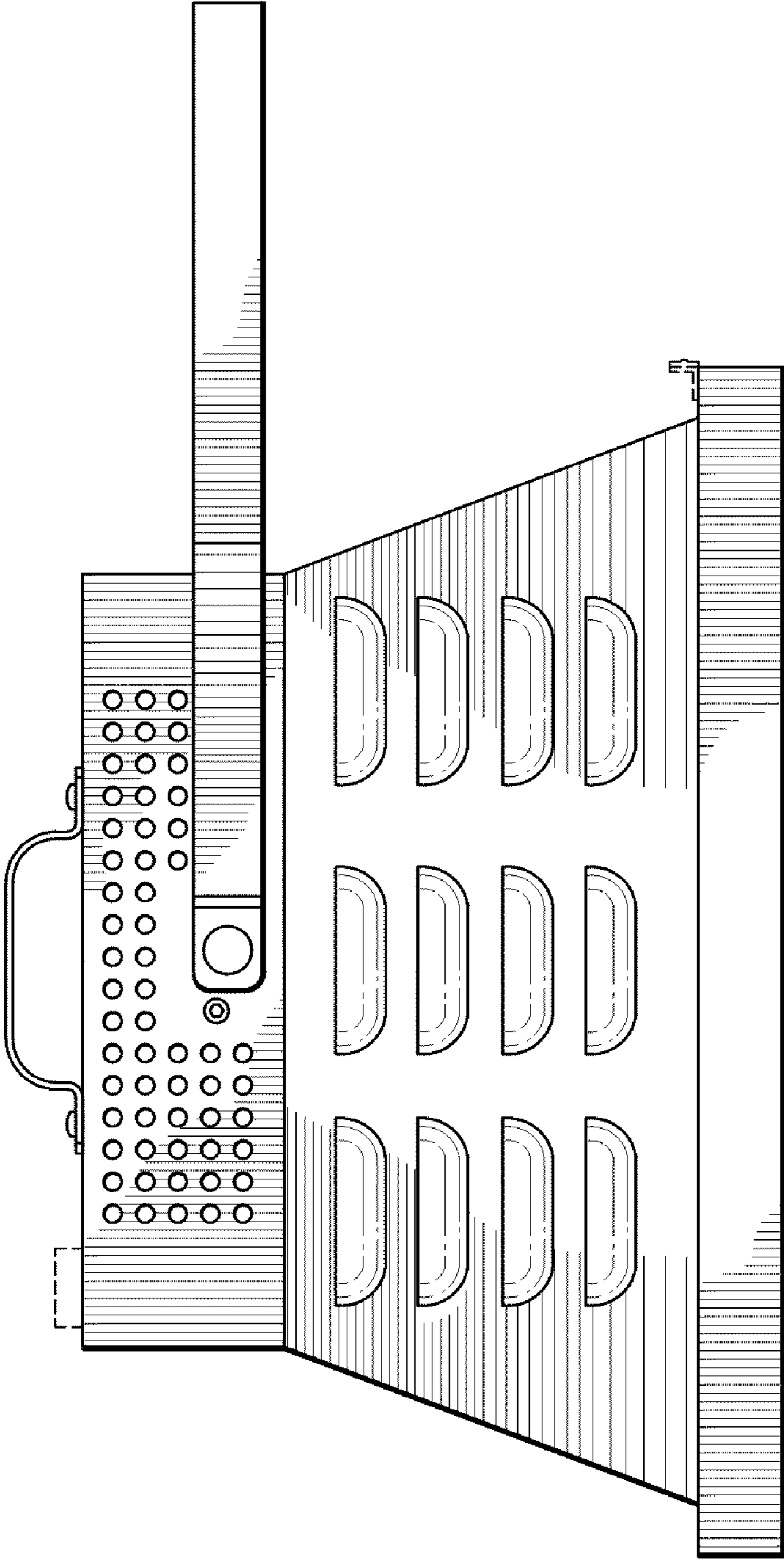

FIG. 7

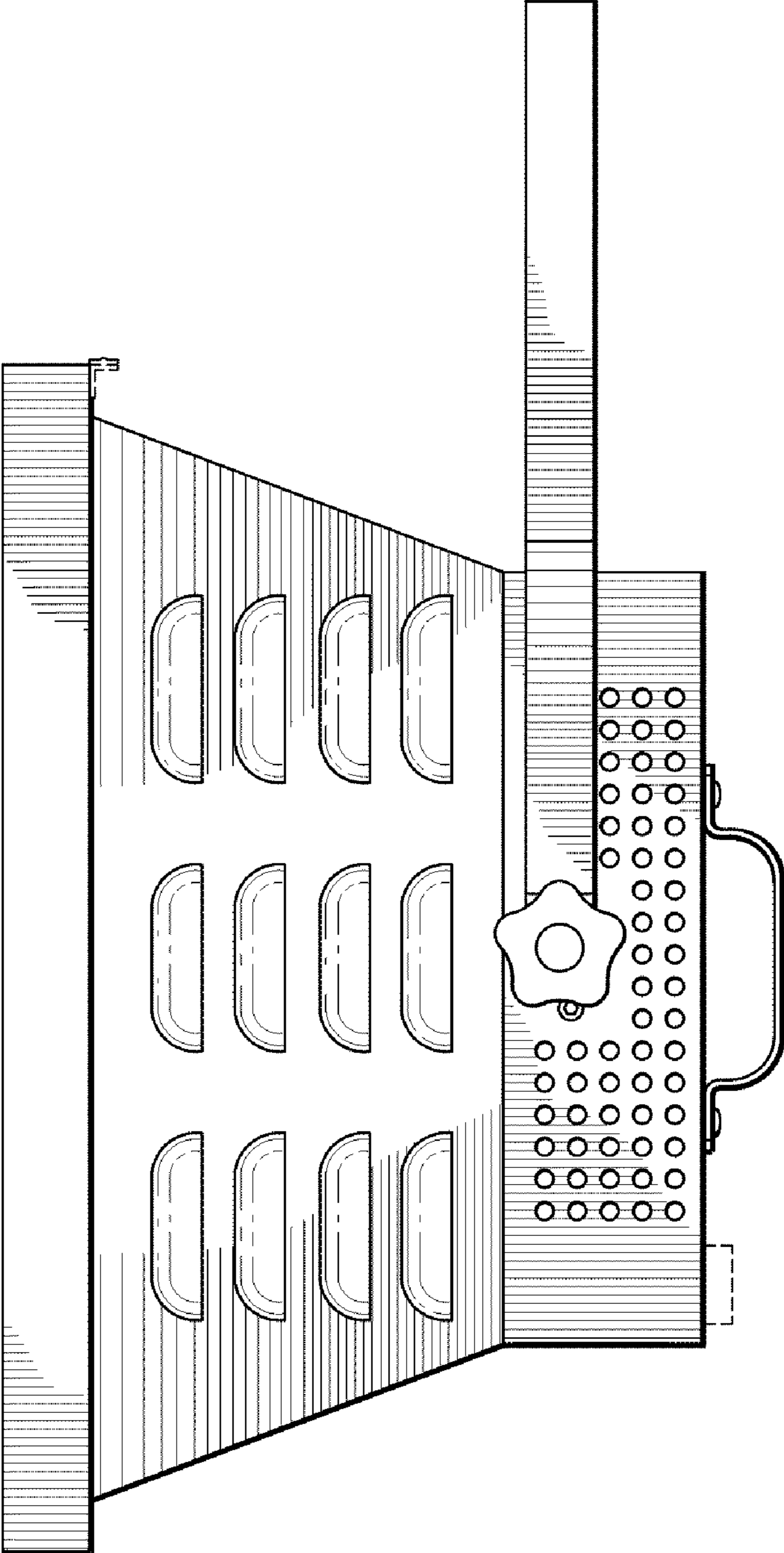

FIG. 8