



US00D650084S

(12) **United States Design Patent**
Tran

(10) **Patent No.:** **US D650,084 S**

(45) **Date of Patent:** **** Dec. 6, 2011**

(54) **PEDICURE BASIN STAND**

(75) Inventor: **Minh Sang Tran**, Cambridge (CA)

(73) Assignee: **Gulfstream Inc.** (CA)

(**) Term: **14 Years**

(21) Appl. No.: **29/385,481**

(22) Filed: **Feb. 15, 2011**

(51) **LOC (9) Cl.** **23-02**

(52) **U.S. Cl.** **D24/204**

(58) **Field of Classification Search** D24/200–205,
D24/212, 213, 172; D28/56, 61; D6/336,
D6/495, 482; 601/6, 15, 64, 157–158, 30–32;
607/44; 4/622, 574.1

See application file for complete search history.

(56) **References Cited**

U.S. PATENT DOCUMENTS

2,531,724	A	*	11/1950	Cevasco	4/572.1
D250,829	S	*	1/1979	Clement	D23/280.1
D252,941	S	*	9/1979	Fairchild	D23/280.1
D253,547	S	*	11/1979	Beddome et al.	D23/280.3
4,216,552	A	*	8/1980	Gurolnick	4/548
D541,060	S	*	4/2007	Fugate et al.	D6/335
D583,957	S	*	12/2008	Bromilow	D24/204
D603,522	S	*	11/2009	Elliott	D24/204
D610,697	S	*	2/2010	Tran	D24/213
D616,560	S	*	5/2010	Cong	D24/204

D622,858	S	*	8/2010	Jan	D24/204
D624,656	S	*	9/2010	Ton	D24/204
D632,798	S	*	2/2011	Tran	D24/213

* cited by examiner

Primary Examiner — David Muller

(74) *Attorney, Agent, or Firm* — Jones, Walker, Waechter, Poitevent, Carrere & Denegre, LLP

(57) **CLAIM**

The ornamental design for a pedicure basin stand, as shown and described.

DESCRIPTION

FIG. 1 is a rear perspective view of the pedicure basin stand. FIG. 2 is a front perspective view of the pedicure basin stand. FIG. 3 is a top plan view of the pedicure basin stand.

FIG. 4 is a right side elevation view of the pedicure basin stand.

FIG. 5 is a left side elevation view of the pedicure basin stand.

FIG. 6 is a front elevation view of the pedicure basin stand. FIG. 7 is a rear elevation view of the pedicure basin stand; and,

FIG. 8 is a top perspective view of the pedicure basin stand, shown in conjunction with a pedicure spa chair, basin and footrest, the pedicure spa, basin and footrest being shown in broken lines.

The features shown in broken lines depict environmental subject matter only and form no part of the design.

1 Claim, 5 Drawing Sheets

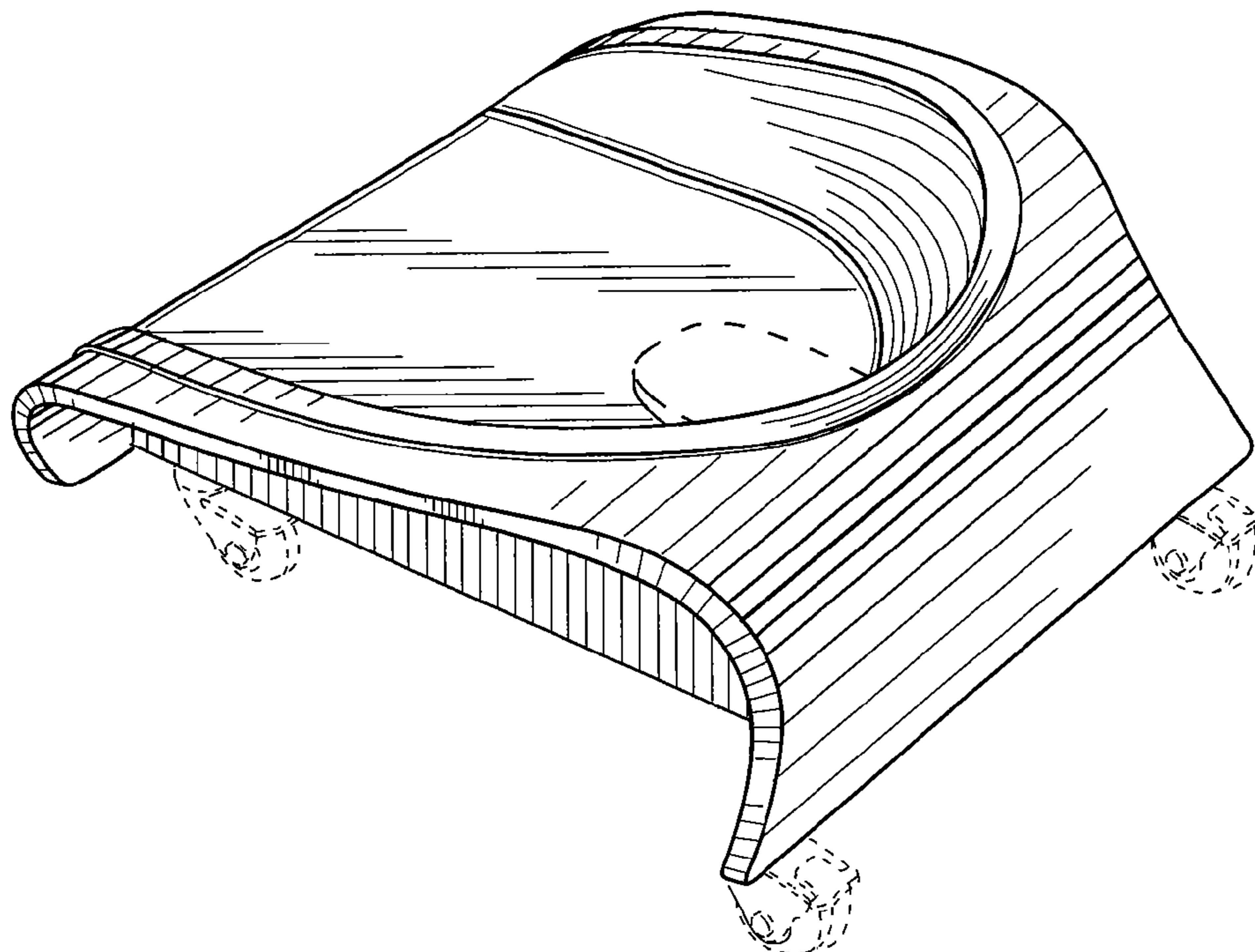

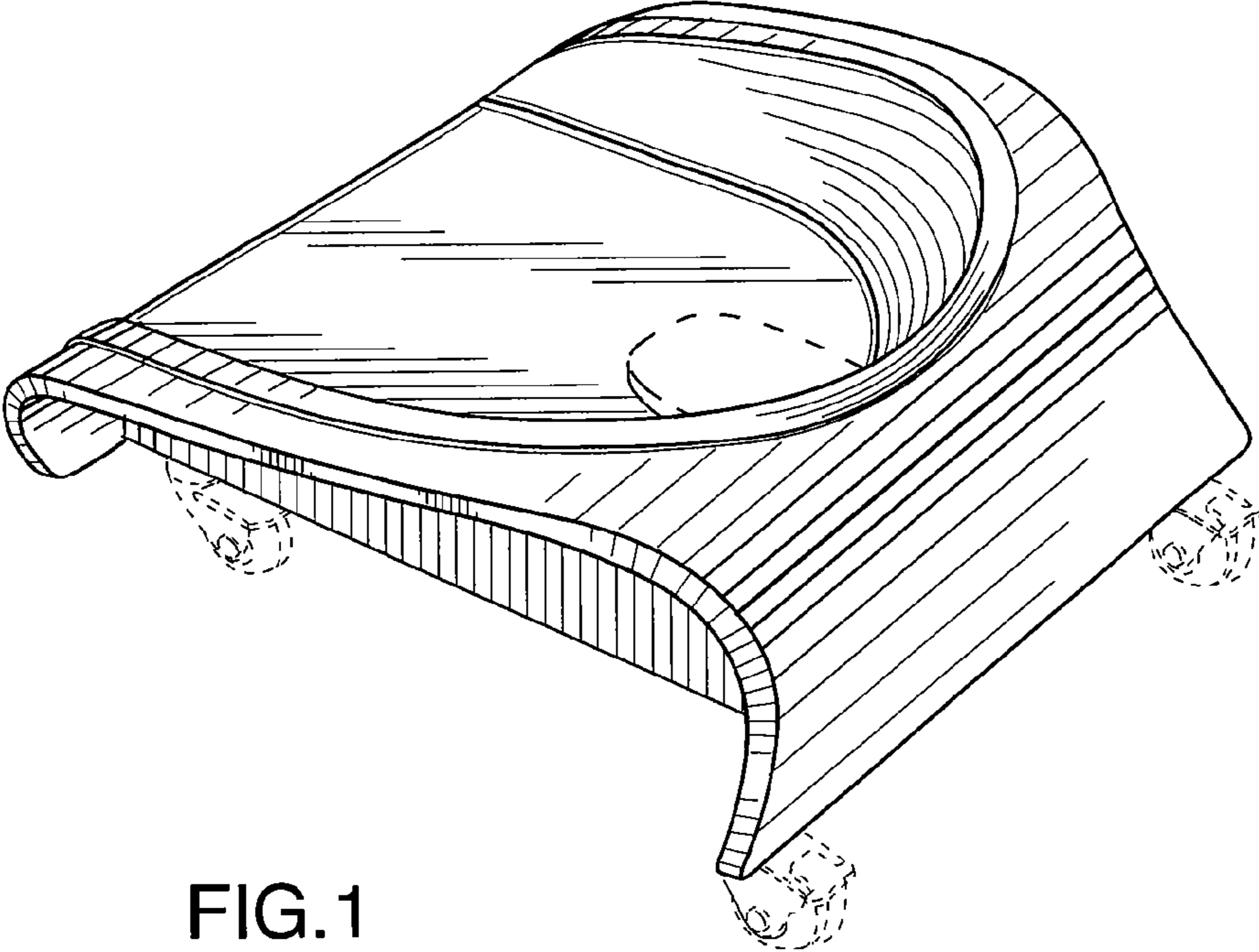

FIG. 1

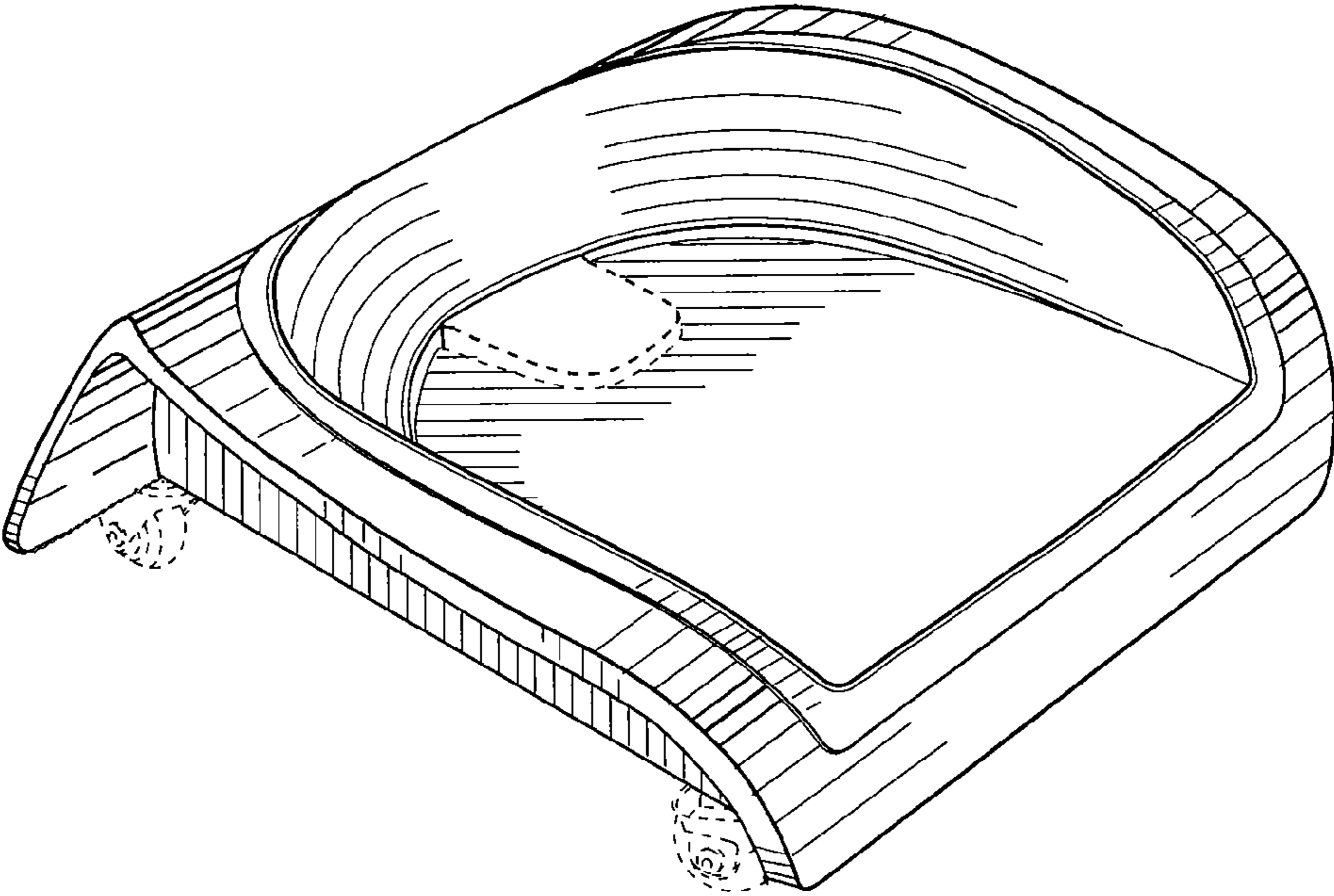

FIG. 2

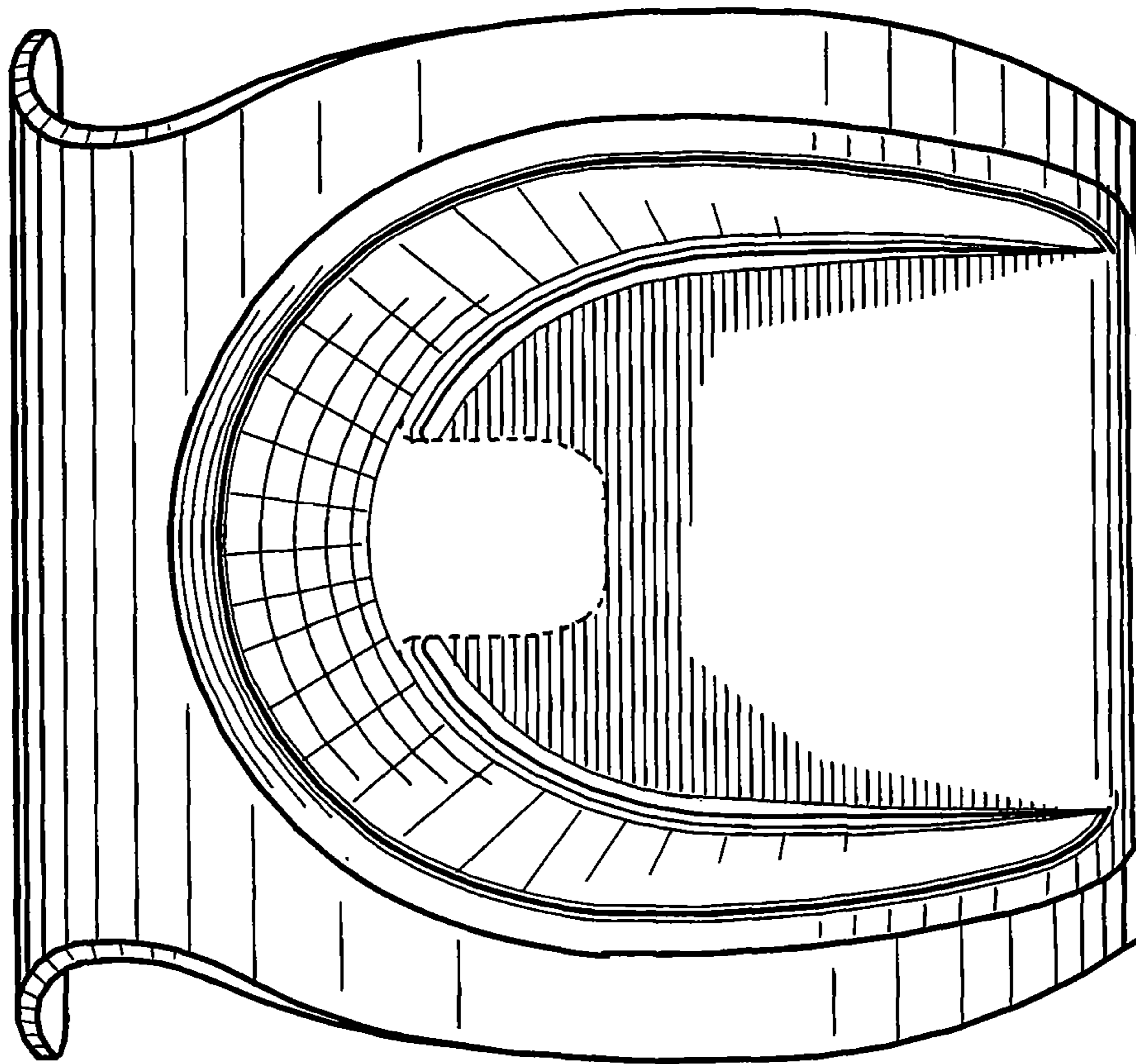

FIG.3

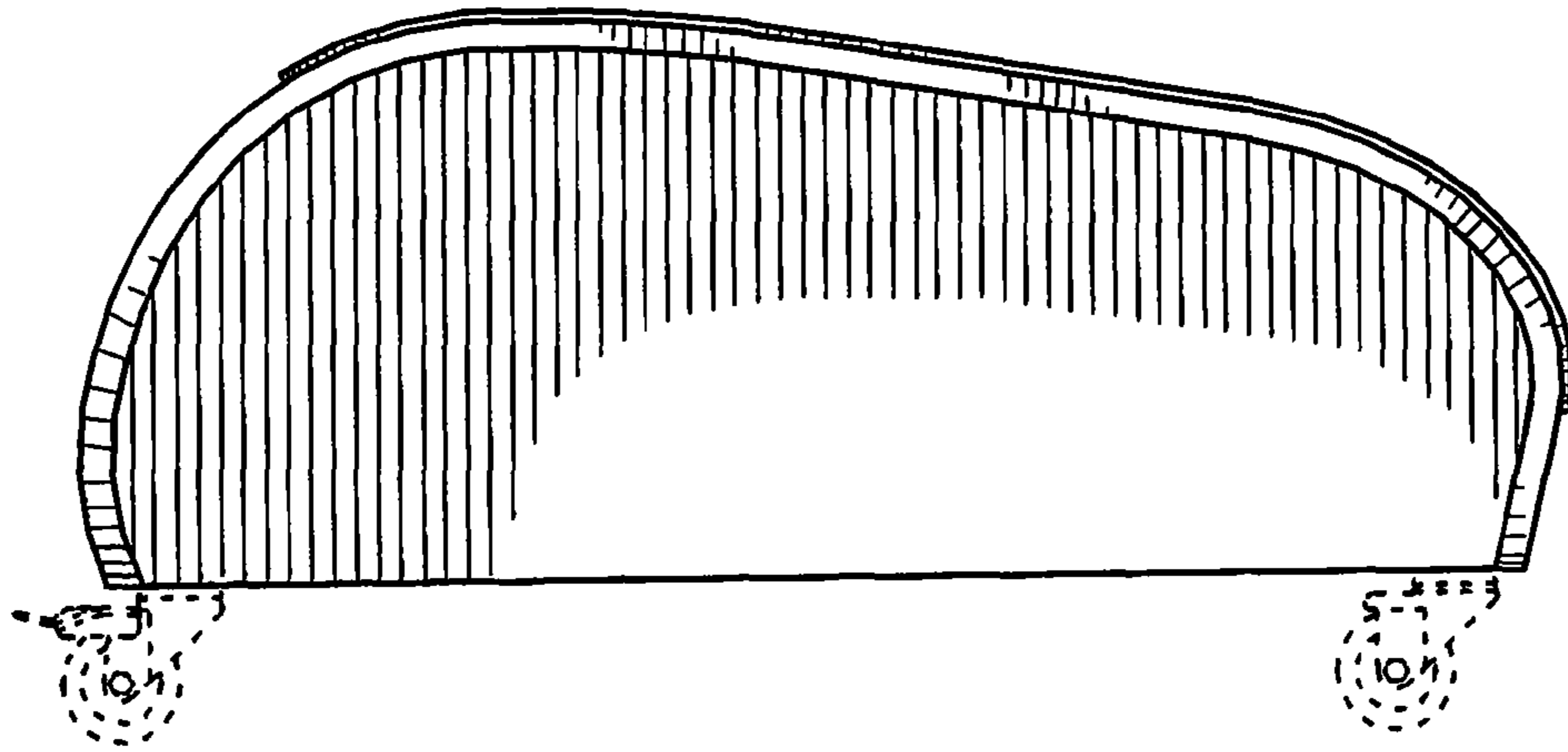

FIG. 4

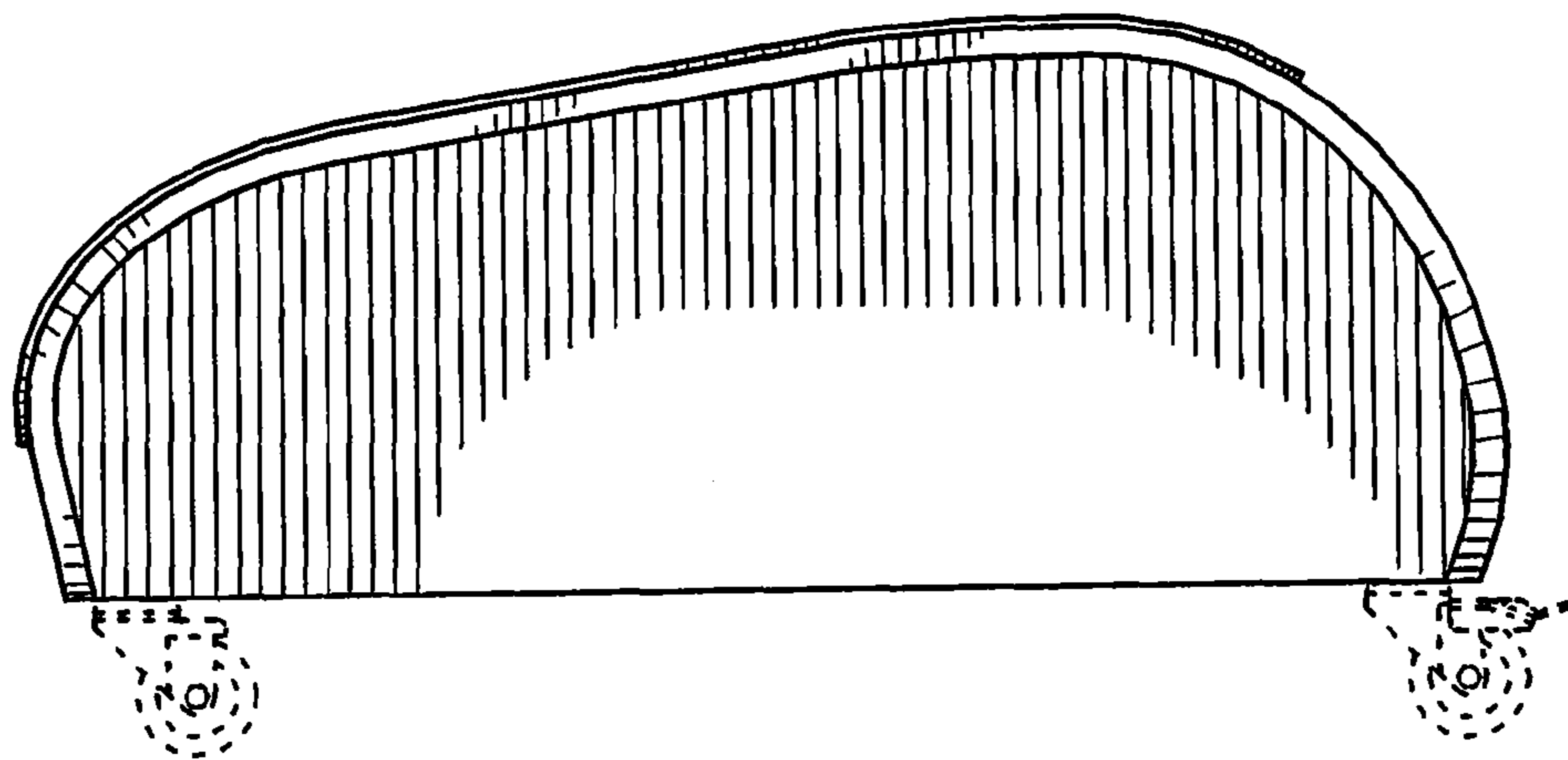

FIG. 5

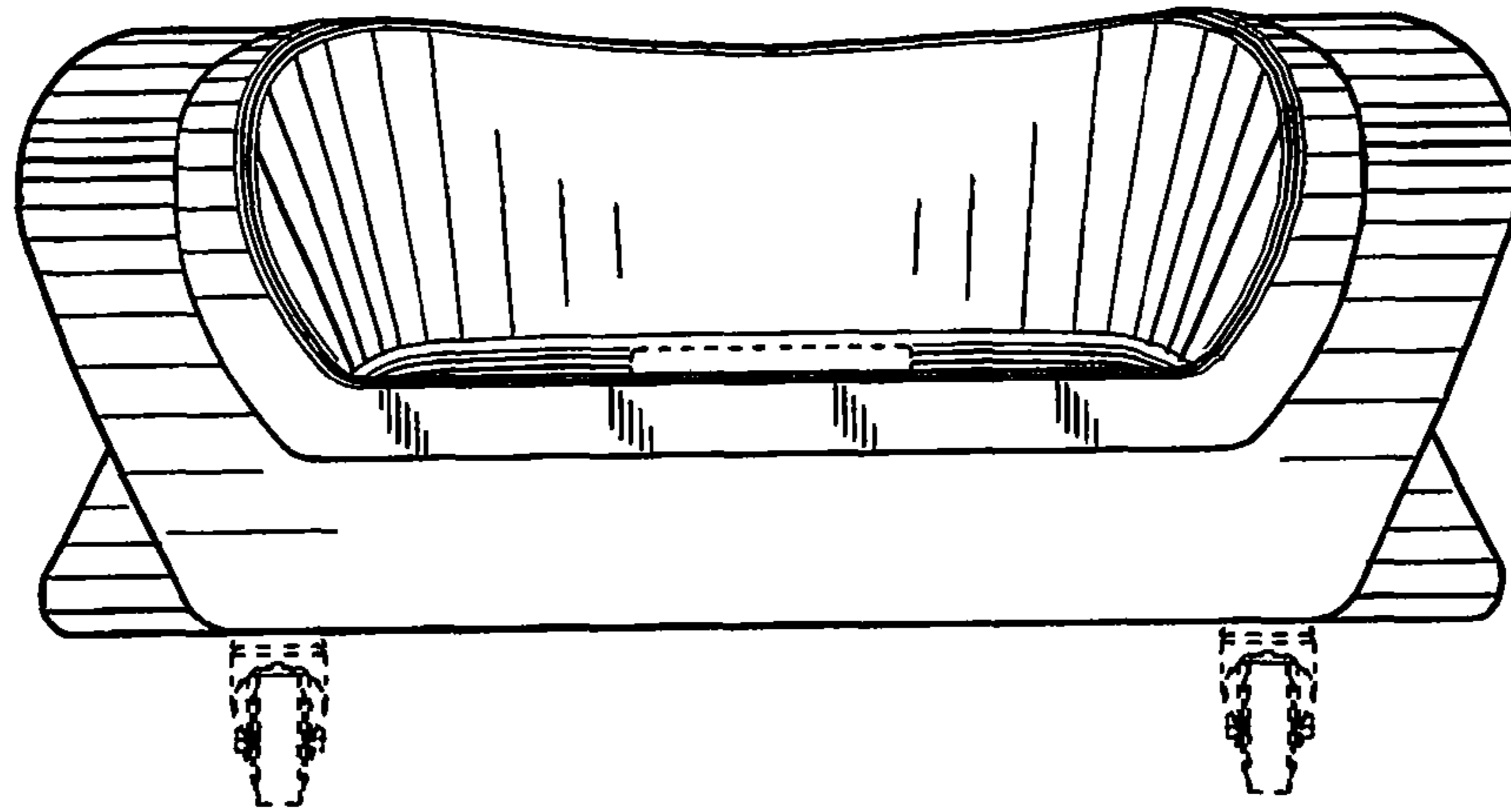

FIG. 6

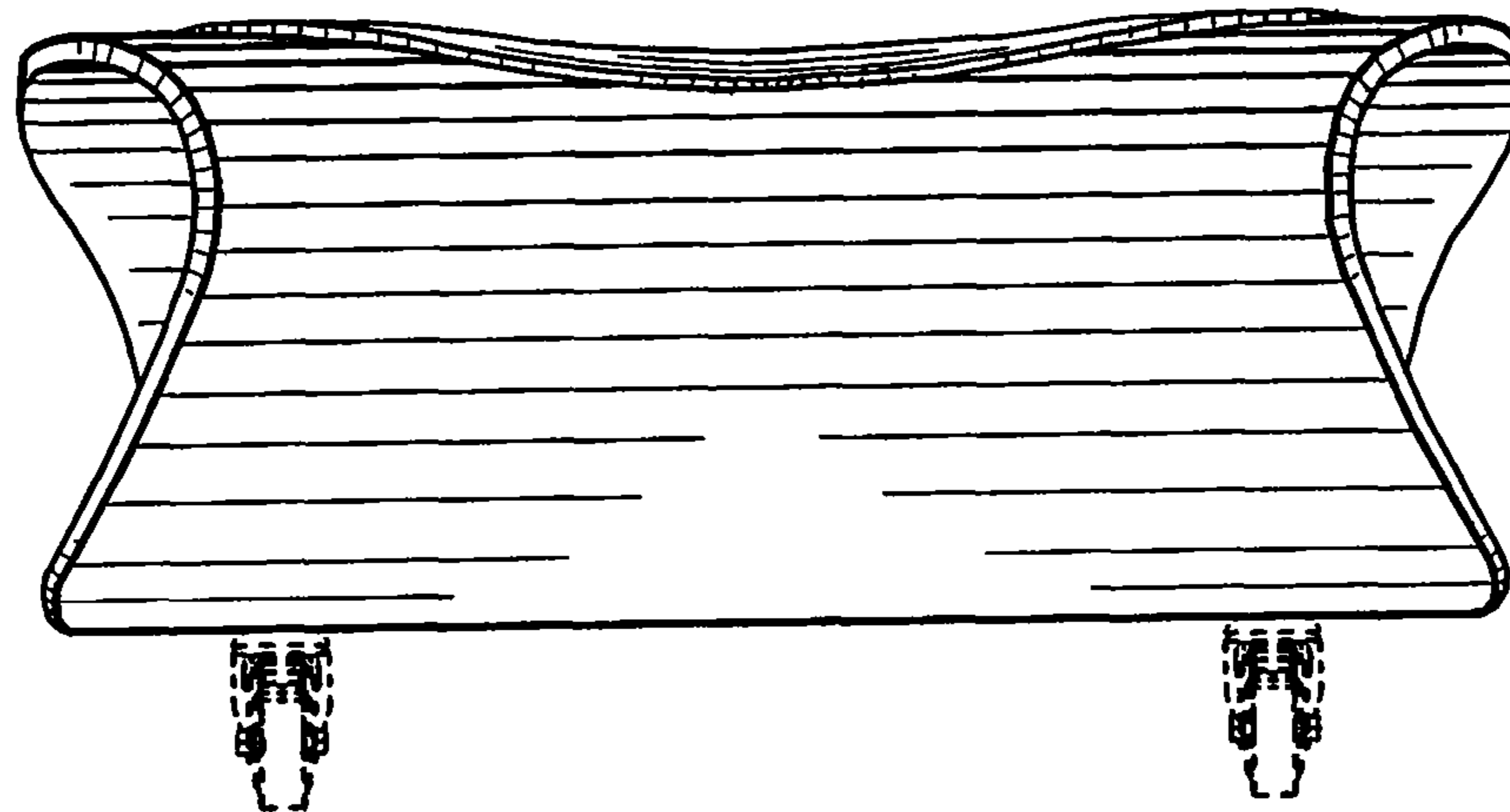

FIG. 7

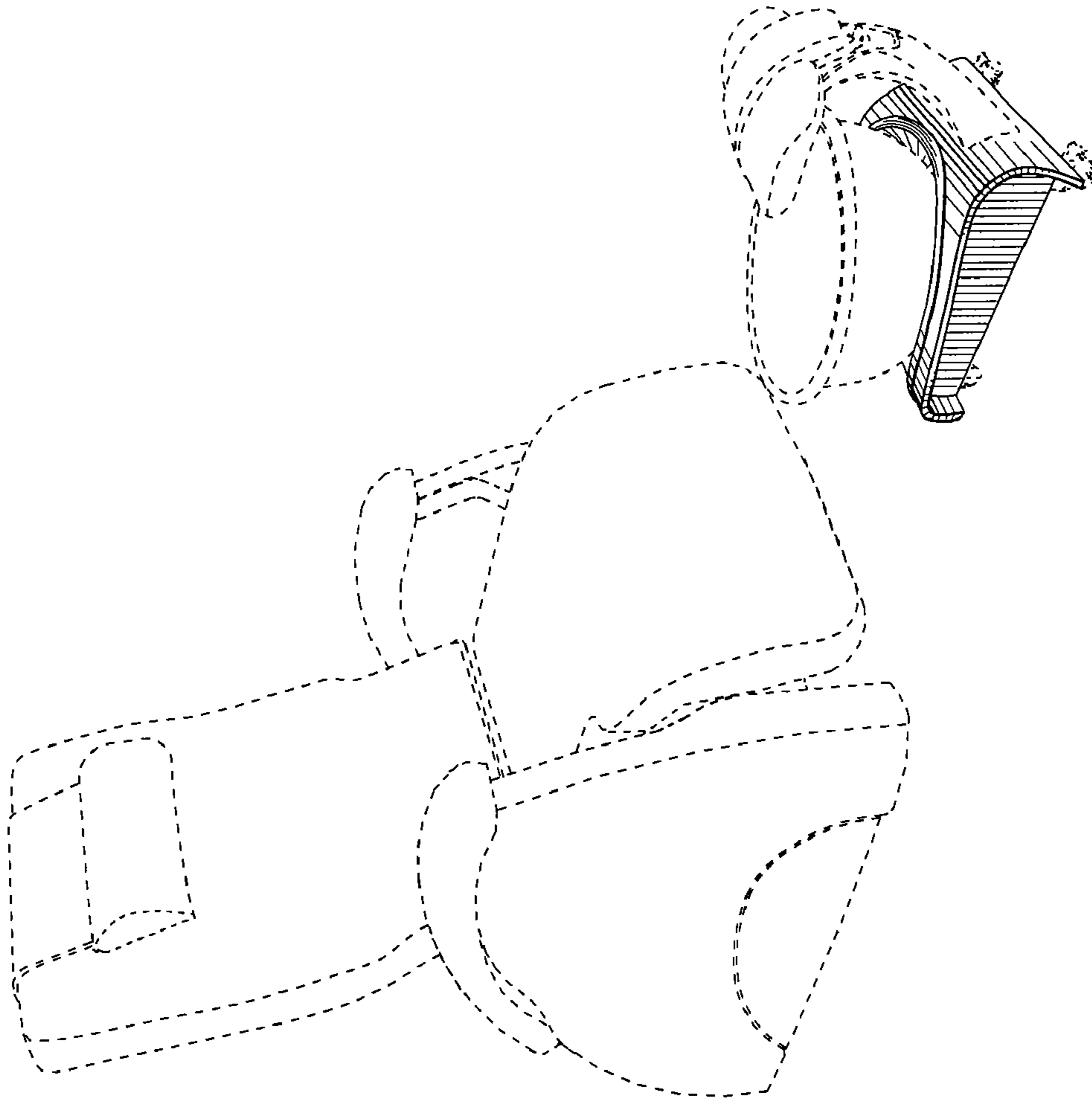

FIG. 8