



US00D650016S

(12) **United States Design Patent**
Yi et al.

(10) **Patent No.:** **US D650,016 S**

(45) **Date of Patent:** **** *Dec. 6, 2011**

(54) **DESKTOP SIGN**

(75) Inventors: **Jean Yi**, Foshan (CN); **Danielle Rodgers**, Indianapolis, IN (US)

(73) Assignee: **Deflecto, LLC**, Indianapolis, IN (US)

(*) Notice: This patent is subject to a terminal disclaimer.

(**) Term: **14 Years**

(21) Appl. No.: **29/384,277**

(22) Filed: **Jan. 28, 2011**

(51) **LOC (9) Cl.** **20-03**

(52) **U.S. Cl.** **D20/15**

(58) **Field of Classification Search** D20/10,
D20/13-15, 18, 19, 29, 39-43, 99; 40/358,
40/446, 452, 453, 538, 541, 542, 545-548,
40/563, 564, 568, 570-574, 582, 584, 594,
40/600, 605, 615, 617, 618, 624; D6/300,
D6/310, 314; D10/109.1, 109.2; 248/174;
362/812

See application file for complete search history.

(56) **References Cited**

U.S. PATENT DOCUMENTS

3,341,162 A * 9/1967 Ruchlis 248/174
D343,065 S * 1/1994 Barbieri D6/310
D386,008 S * 11/1997 Wong D6/310

D435,270 S * 12/2000 Healy D20/10
D445,263 S * 7/2001 Malamud D6/310
D548,796 S * 8/2007 Sachnoff D20/43
D551,717 S 9/2007 Diller
D551,718 S 9/2007 Diller
D577,075 S * 9/2008 Bode D20/43
D633,568 S * 3/2011 Hill et al. D20/10

* cited by examiner

Primary Examiner — Mary Ann Calabrese

(74) *Attorney, Agent, or Firm* — SNR Denton US LLP;
Brian R. McGinley

(57) **CLAIM**

The ornamental design for a desktop sign, as shown and described.

DESCRIPTION

FIG. 1 is a front elevational view of the desktop sign illustrating the new design;

FIG. 2 is a right side view of the desktop sign illustrated in FIG. 1; the left side view of the desktop sign is a mirror image of that of the right side view in FIG. 2

FIG. 3 is a rear view of the desktop sign illustrated in FIG. 1; FIG. 4 is an enlarged top view of the desktop sign illustrated in FIG. 1;

FIG. 5 is an enlarged bottom view of the desktop sign illustrated in FIG. 1;

FIG. 6 is a front perspective view of the desktop sign shown in FIG. 1; and,

FIG. 7 is a rear perspective view of the desktop sign illustrated in FIG. 1.

1 Claim, 5 Drawing Sheets

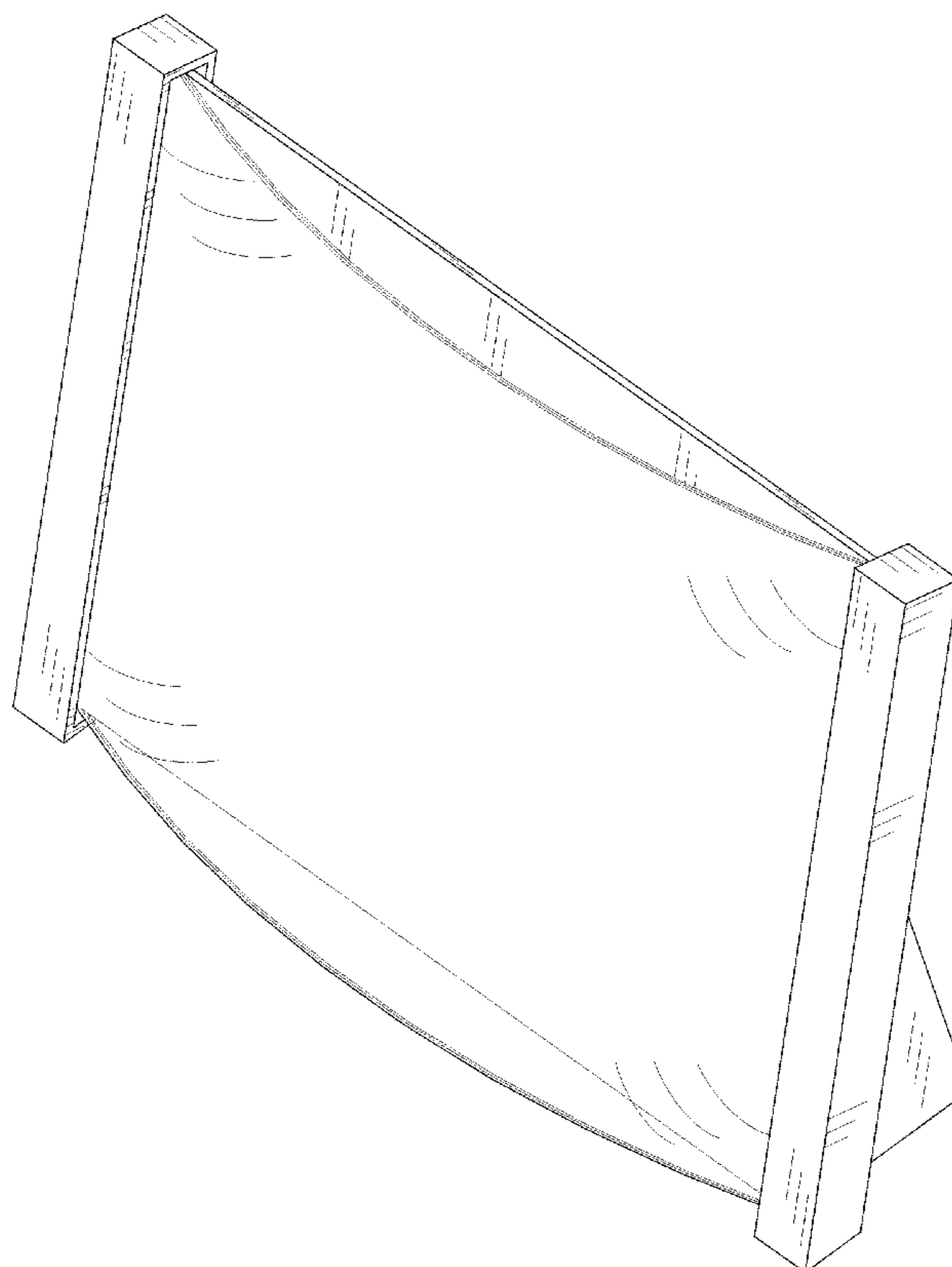

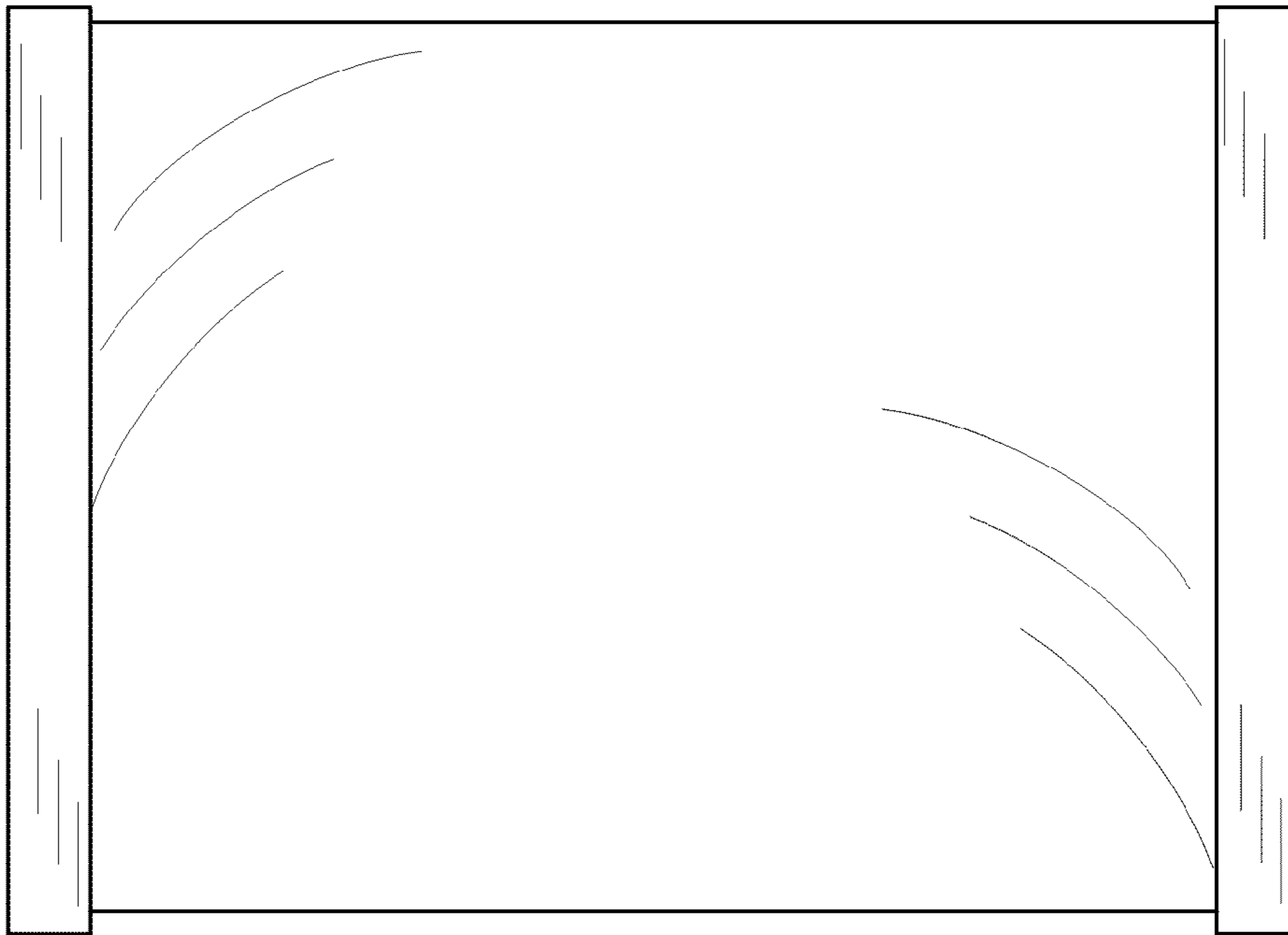

Fig. 1

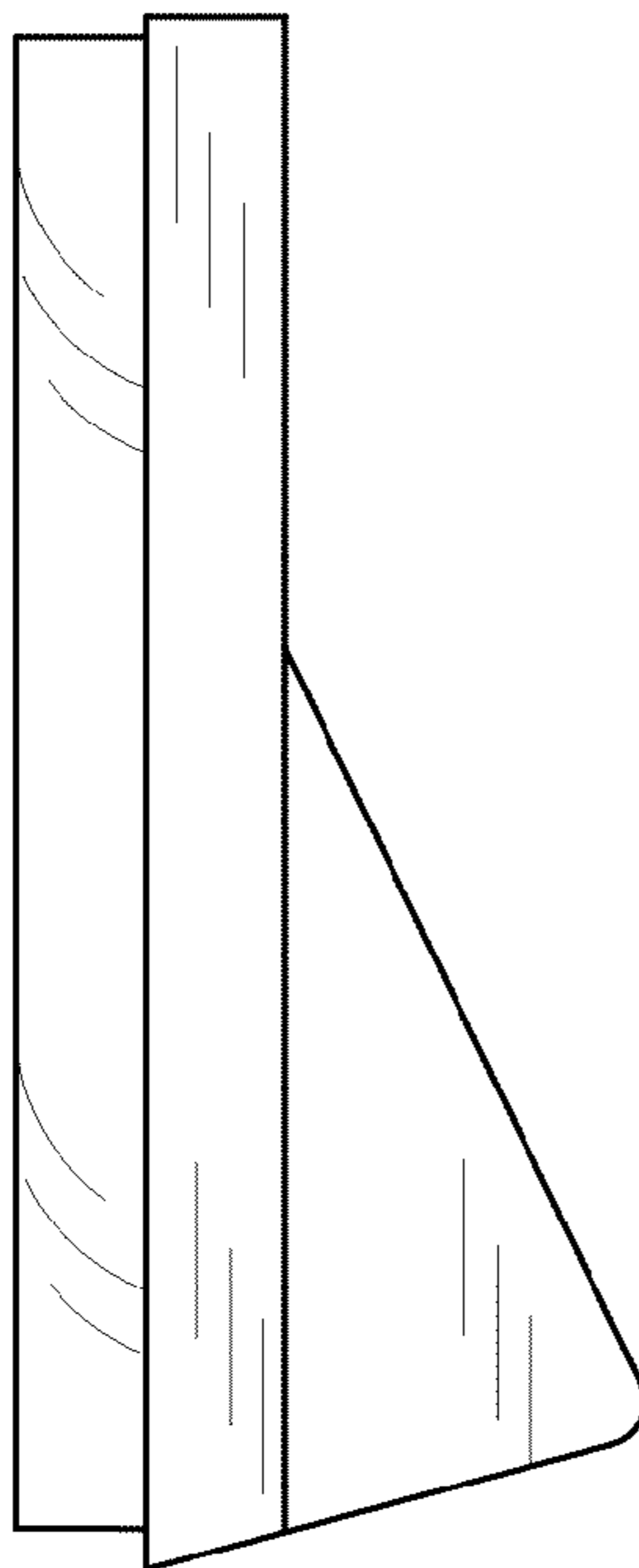

Fig. 2

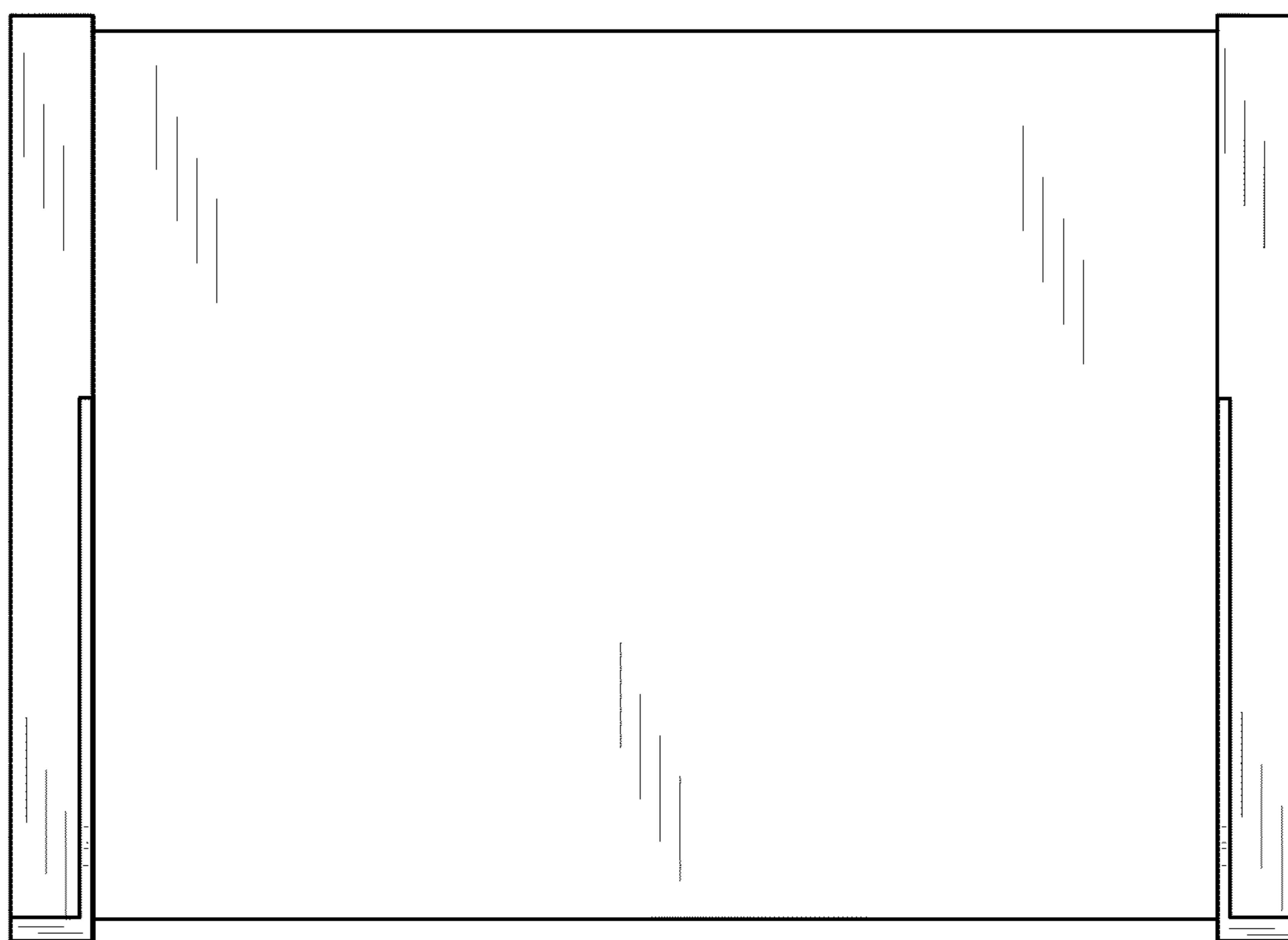

Fig. 3

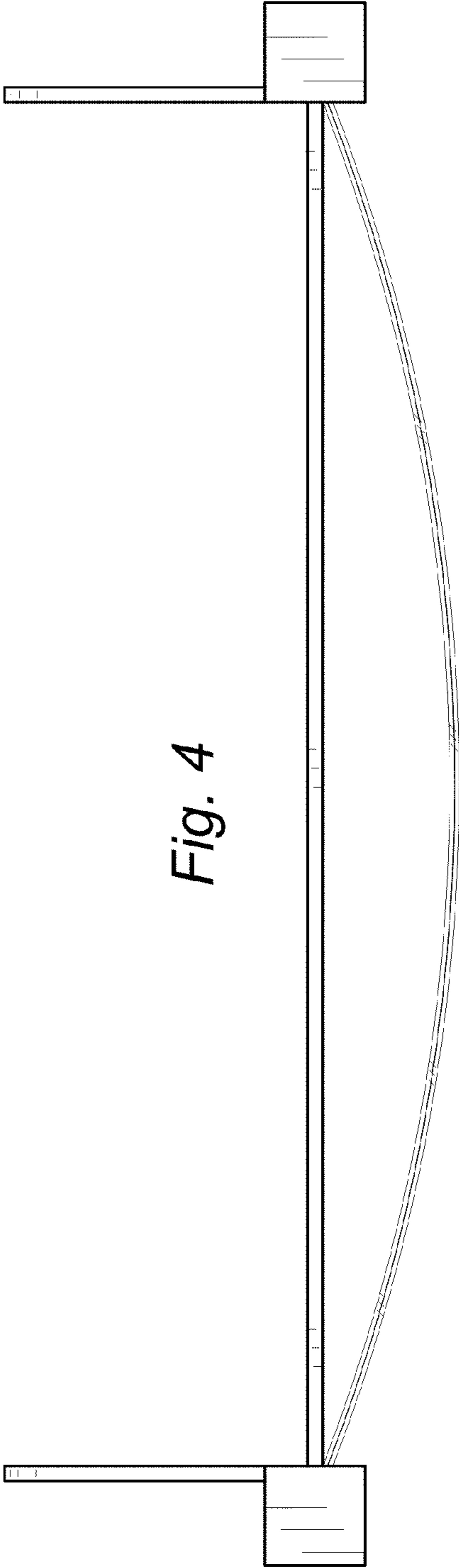

Fig. 4

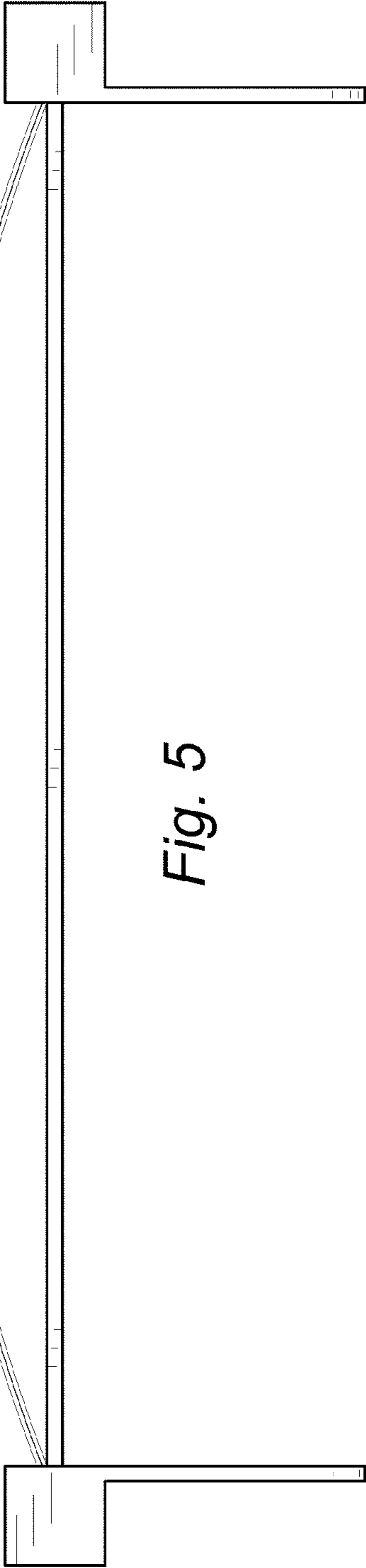

Fig. 5

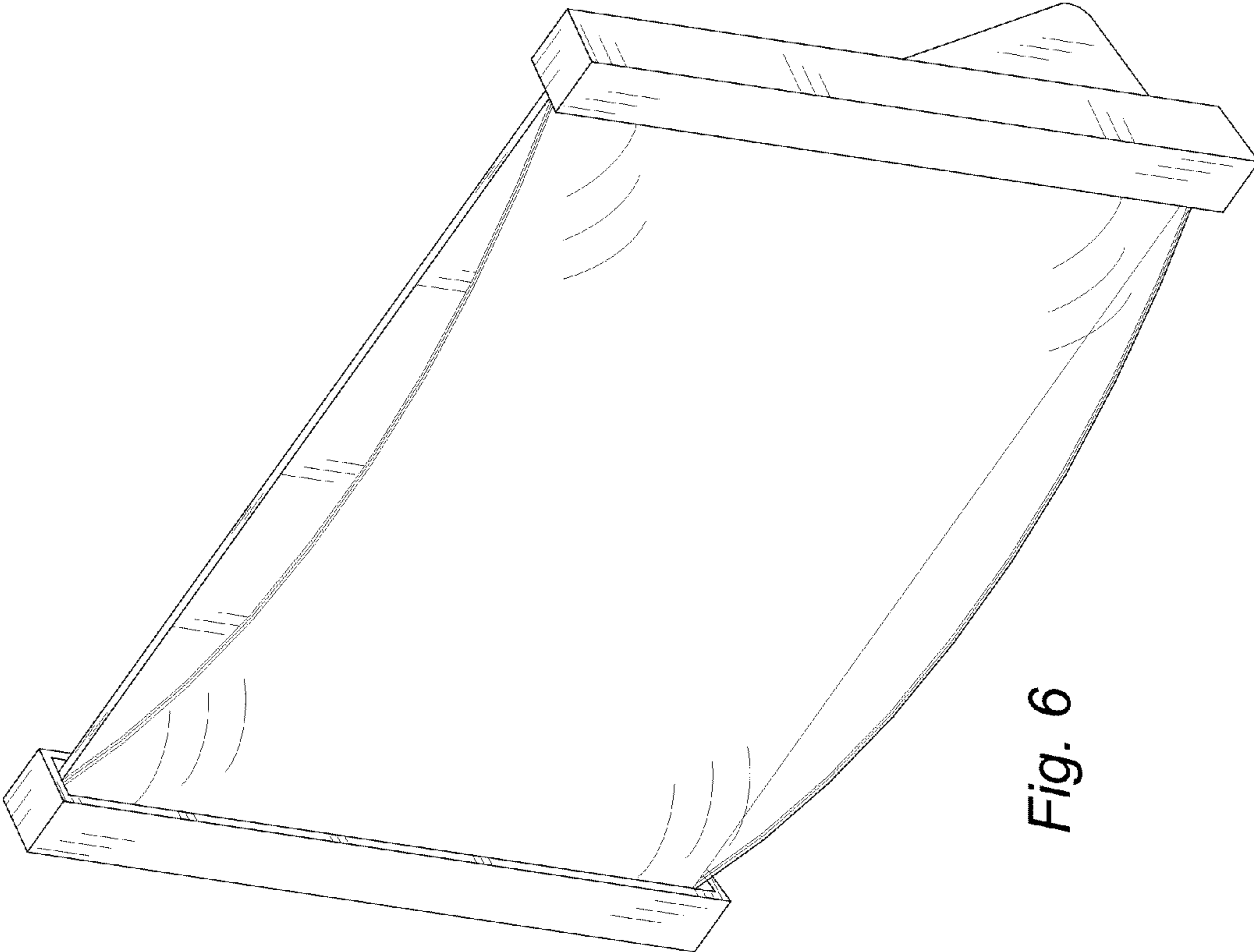

Fig. 6

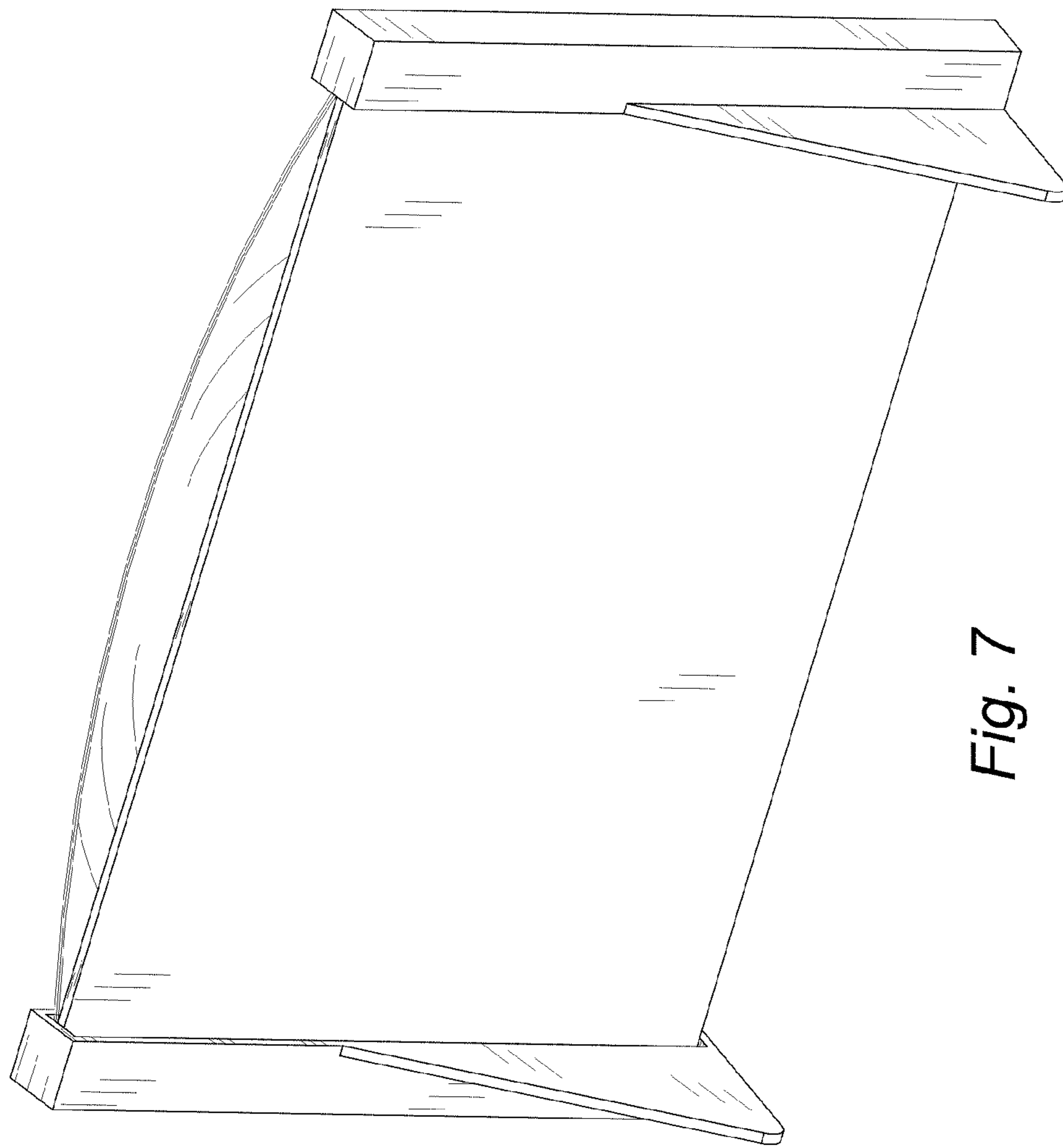

Fig. 7