



US00D649999S

(12) **United States Design Patent**
Morita et al.

(10) **Patent No.:** **US D649,999 S**

(45) **Date of Patent:** **** Dec. 6, 2011**

(54) **PROJECTOR**

(75) Inventors: **Akio Morita**, Tokyo (JP); **Takahisa Yamada**, Tokyo (JP); **Kazuya Inoue**, Tokyo (JP); **Yoshinao Segawa**, Tokyo (JP)

(73) Assignee: **NEC Display Solutions, Ltd.**, Tokyo (JP)

(**) Term: **14 Years**

(21) Appl. No.: **29/379,855**

(22) Filed: **Nov. 24, 2010**

(30) **Foreign Application Priority Data**

May 28, 2010 (JP) 2010-13218

(51) **LOC (9) Cl.** **16-02**

(52) **U.S. Cl.** **D16/235; D16/225; D16/230**

(58) **Field of Classification Search** D16/221,
D16/225, 229, 230-235; D21/514; D14/128-129;
352/34, 242-243; 353/49, 70, 115, 119,
353/122

See application file for complete search history.

(56) **References Cited**

U.S. PATENT DOCUMENTS

D360,426 S * 7/1995 Maiefski et al. D16/232
5,639,152 A * 6/1997 Nelson 353/119

7,445,342 B2 * 11/2008 Garg 353/119
D627,386 S * 11/2010 Kawaguchi et al. D16/229
D639,331 S * 6/2011 Kawaguchi et al. D16/230
2008/0218707 A1 * 9/2008 Adachi et al. 353/119
2009/0122274 A1 * 5/2009 Saito 353/119
2011/0128510 A1 * 6/2011 Matsumoto et al. 353/119

* cited by examiner

Primary Examiner — Wan Laymon

(74) *Attorney, Agent, or Firm* — Sughrue Mion, PLLC

(57) **CLAIM**

The ornamental design for a projector, as shown and described.

DESCRIPTION

FIG. 1 is a front, left side, top perspective view of a projector showing our new design;

FIG. 2 is a front elevational view thereof;

FIG. 3 is a rear elevational view thereof;

FIG. 4 is a left side elevational view thereof;

FIG. 5 is a right side elevational view thereof;

FIG. 6 is a top plan view thereof; and,

FIG. 7 is a bottom plan view thereof.

The dash-dot and even broken lines adjacent the shaded areas represent the bounds of the claimed design while all other broken lines represent environmental structure and are for illustrative purposes only; the broken lines form no part of the claimed design.

1 Claim, 7 Drawing Sheets

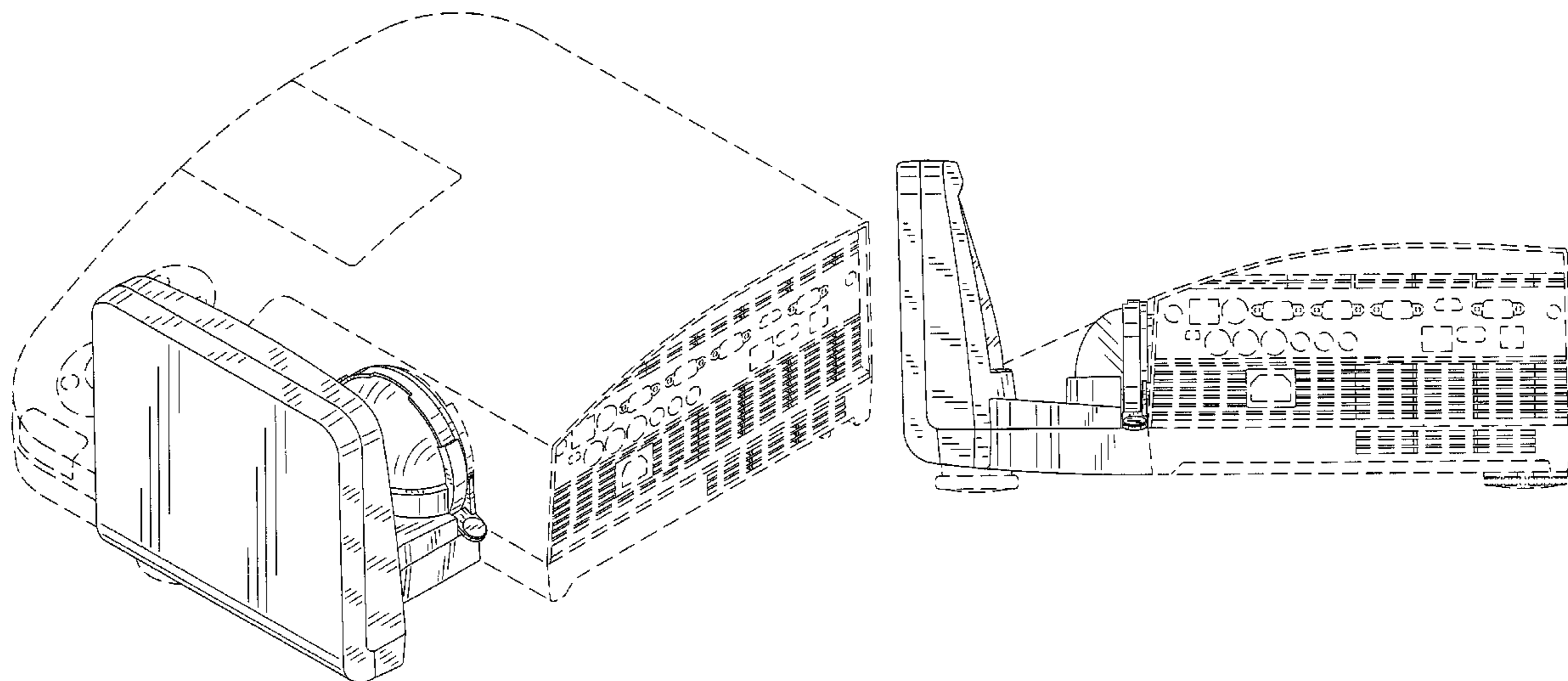

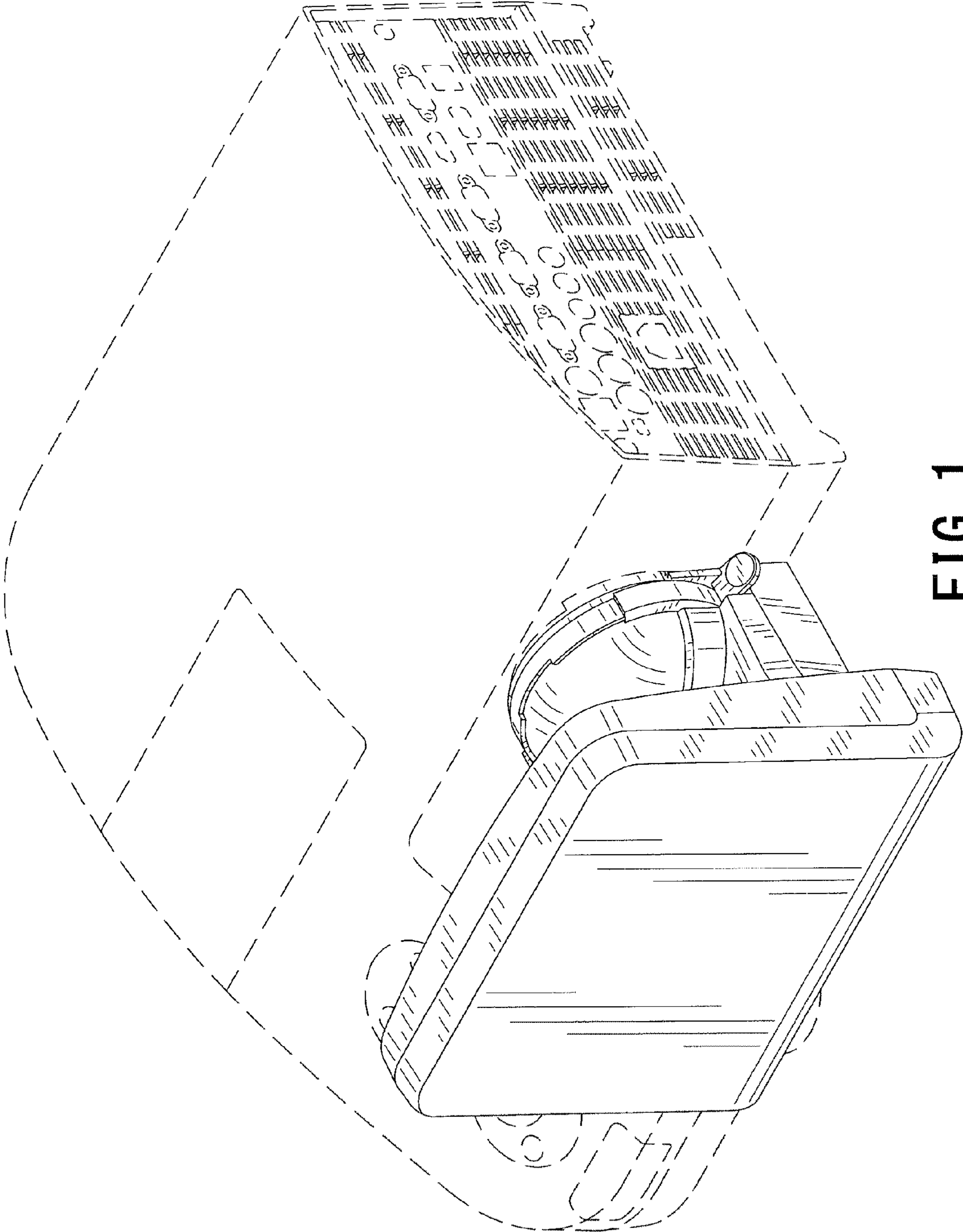

FIG. 1

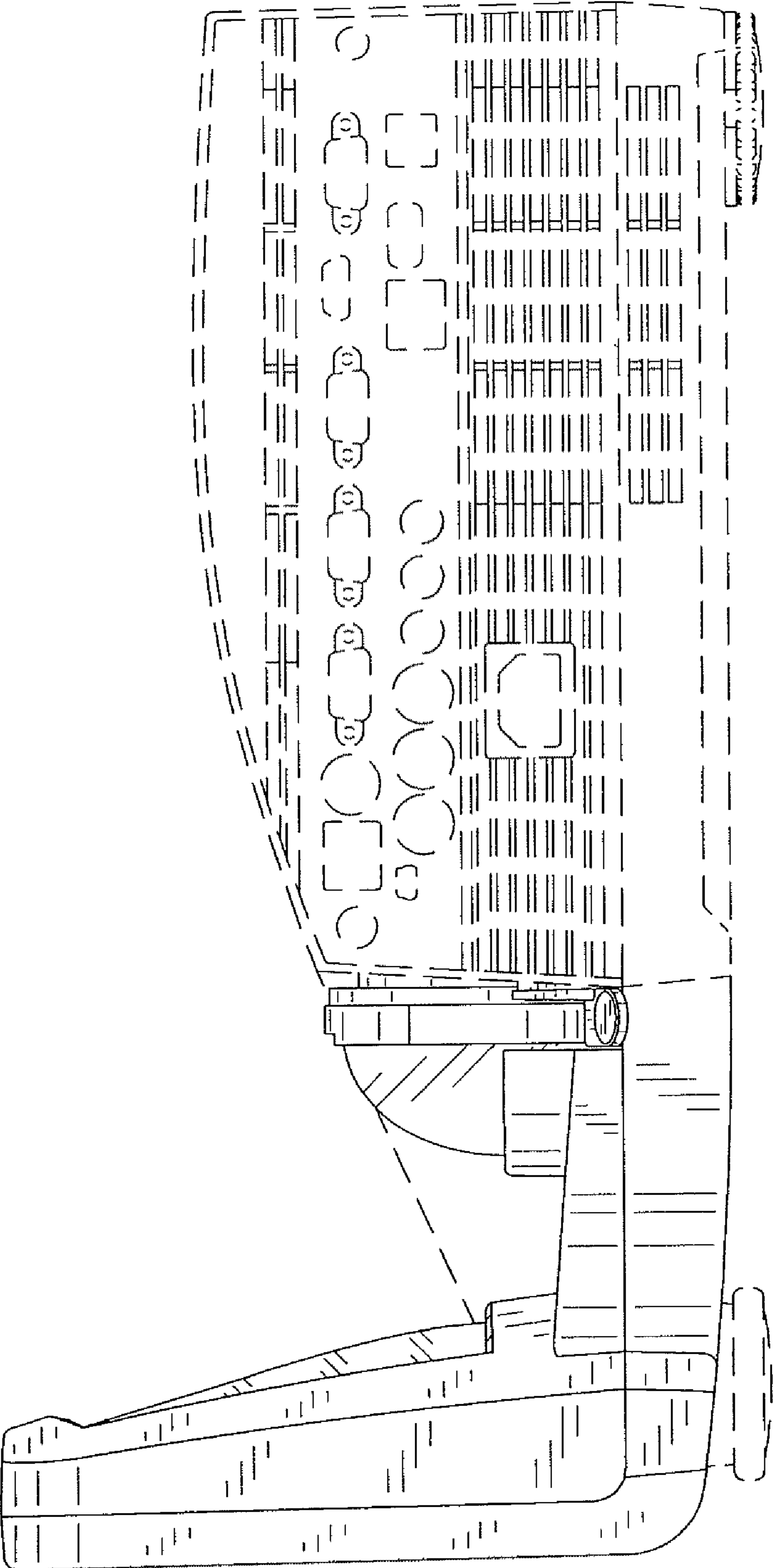

FIG. 2

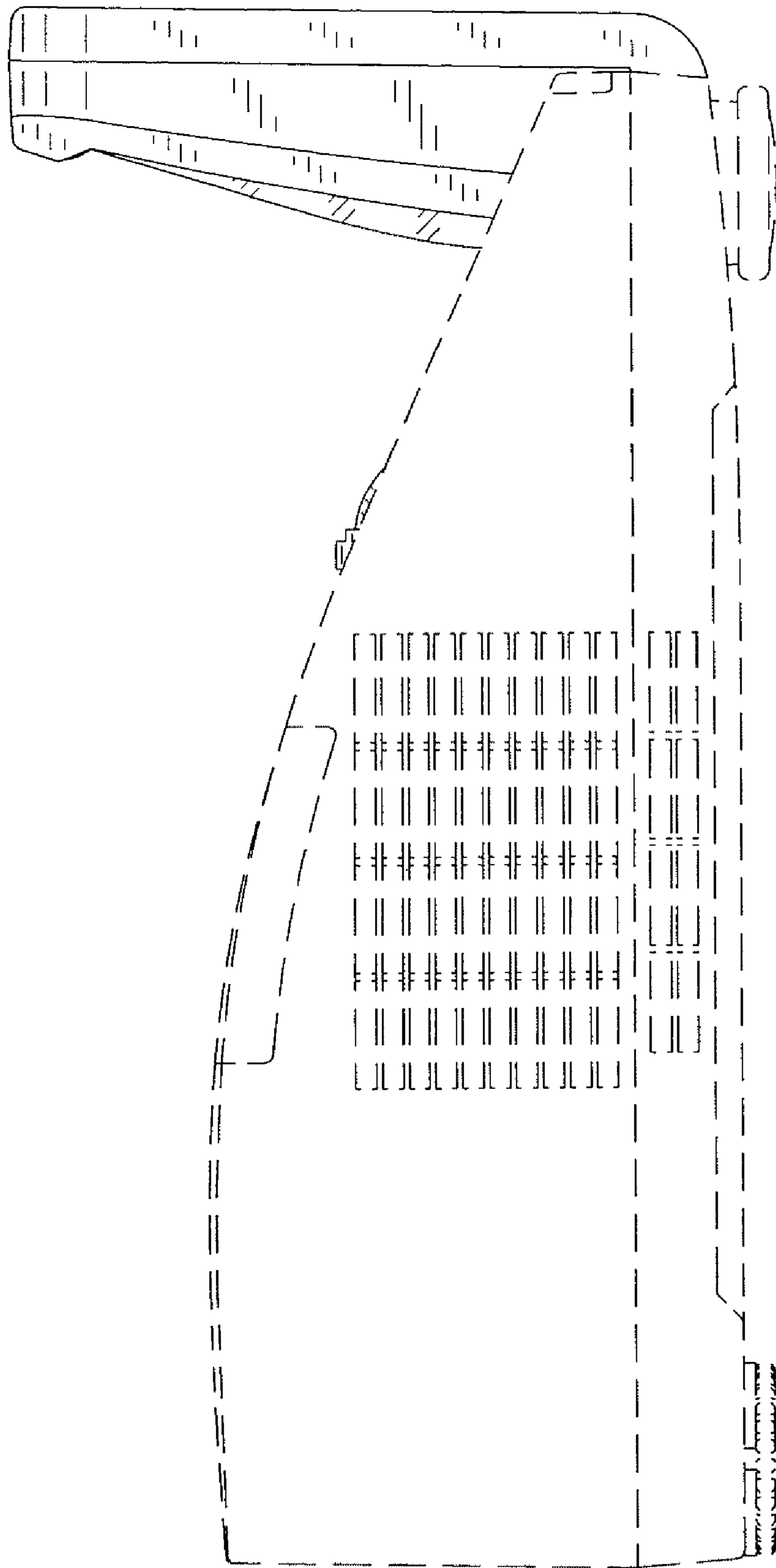

FIG. 3

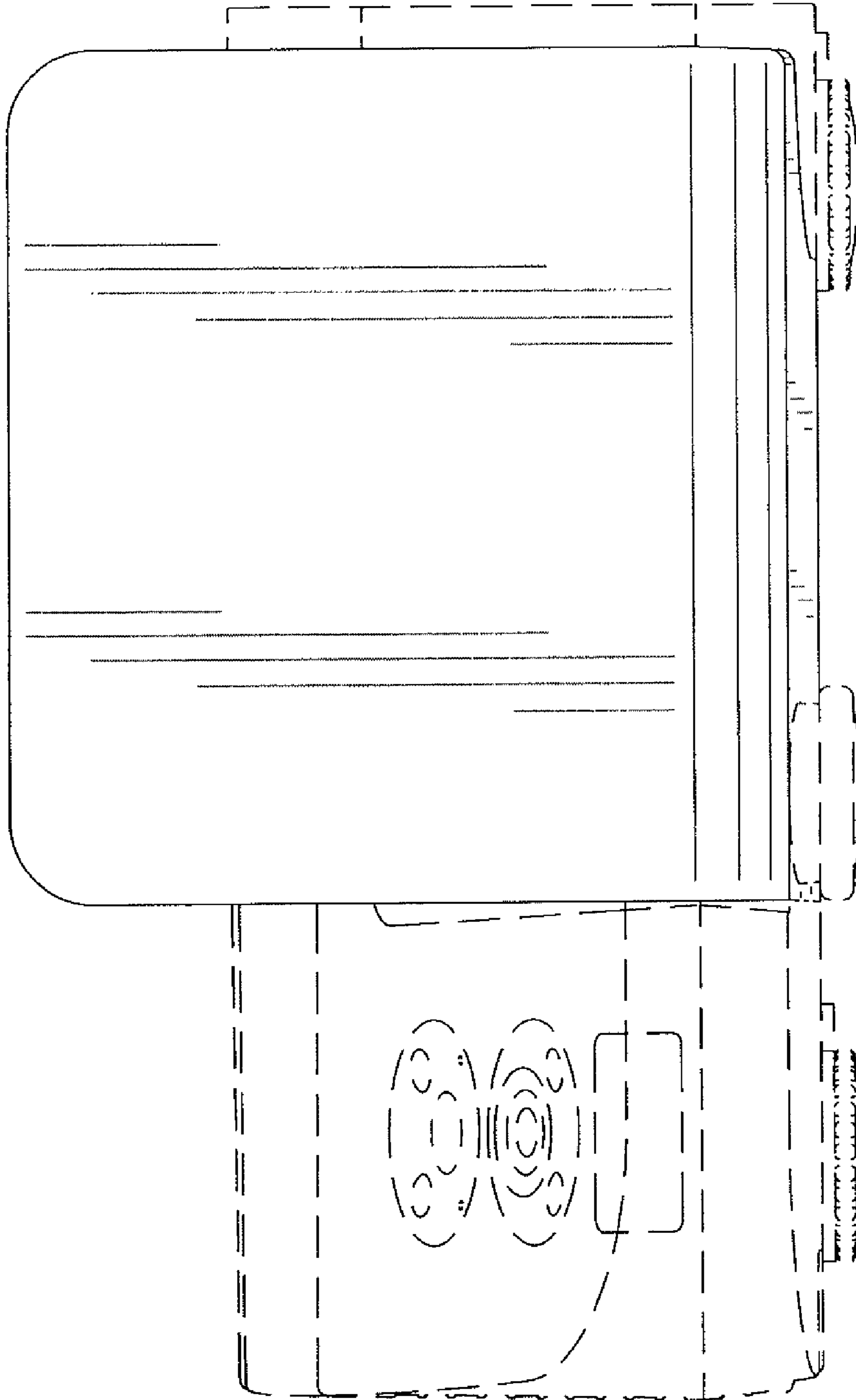

FIG. 4

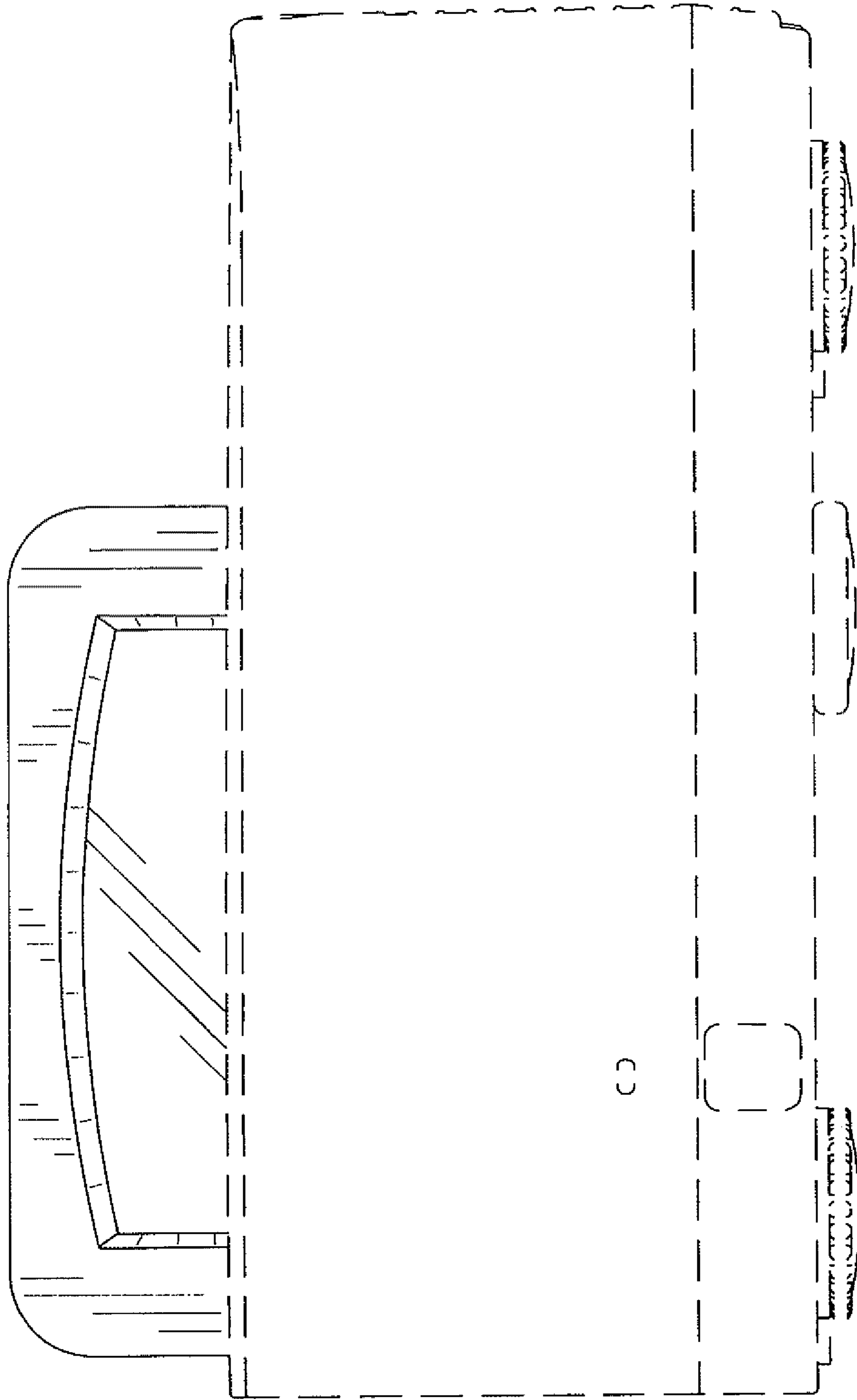

FIG. 5

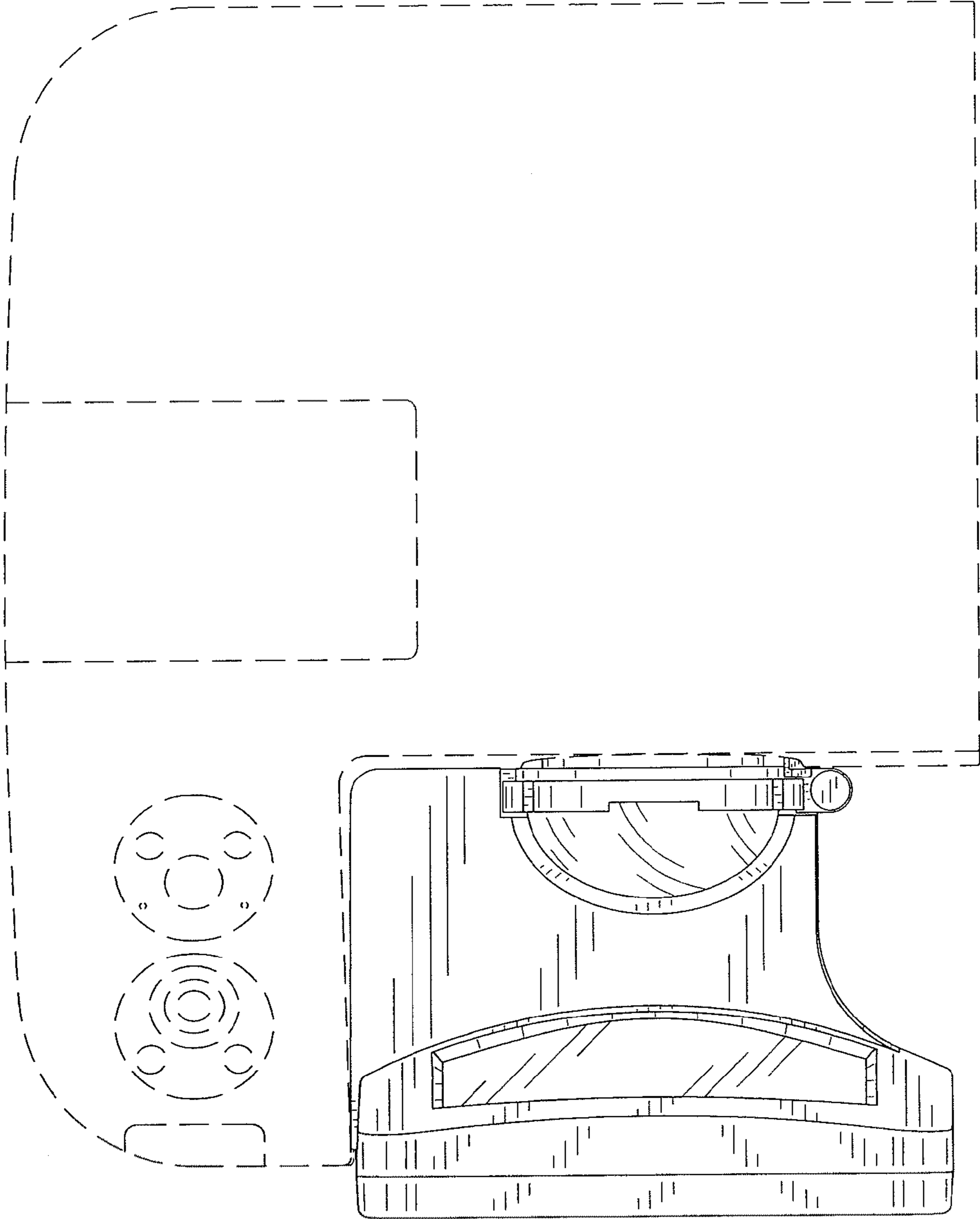

FIG. 6

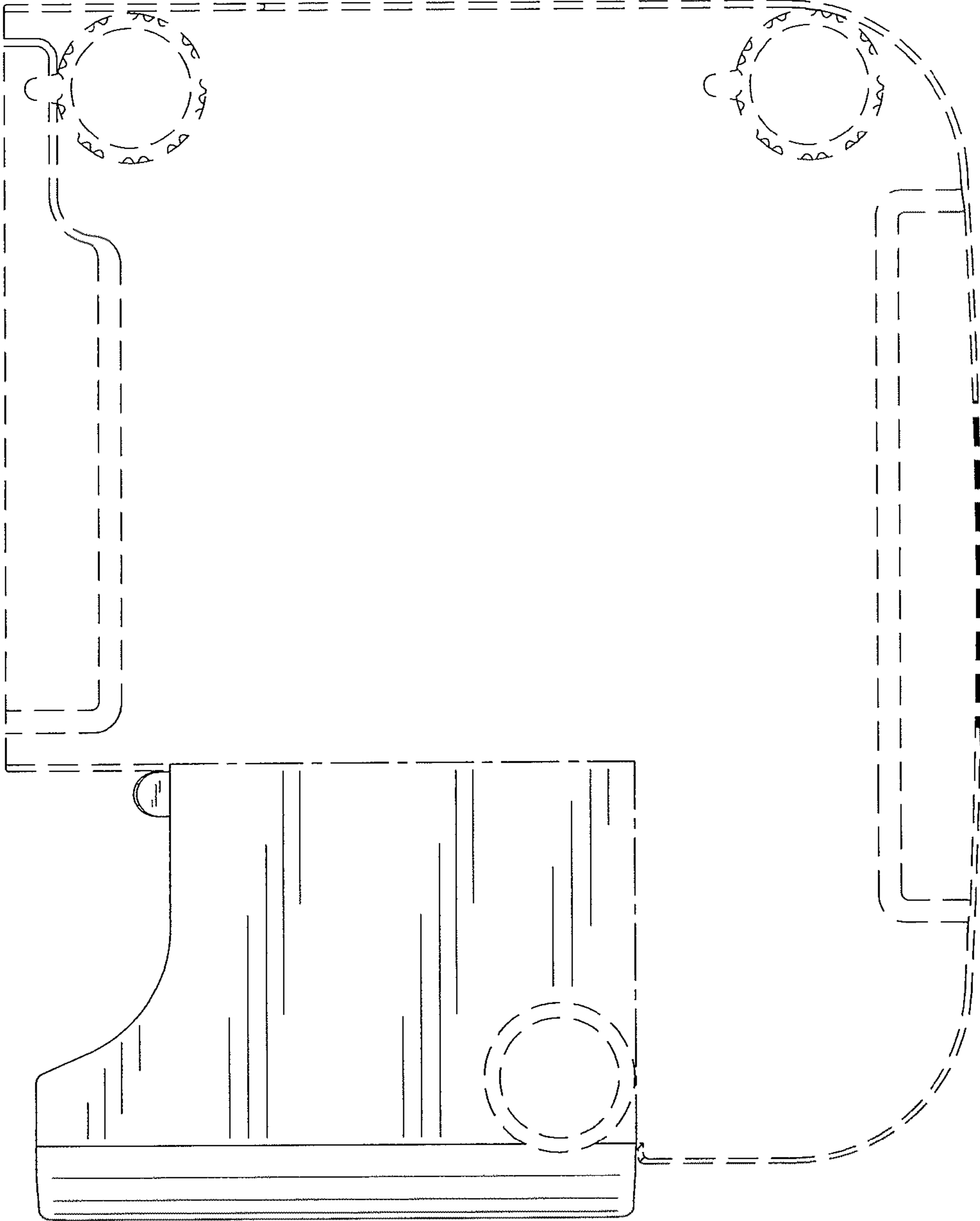

FIG. 7