

US00D649942S

(12) **United States Design Patent**
Shimizu et al.

(10) **Patent No.:** **US D649,942 S**

(45) **Date of Patent:** **** *Dec. 6, 2011**

(54) **LIGHT-EMITTING DIODE**

(75) Inventors: **Satoshi Shimizu**, Kitakyushu (JP);
Kazuhisa Iwashita, Kitakyushu (JP);
Tatsuo Tonedachi, Himeji (JP);
Kazuhiro Inoue, Kitakyushu (JP);
Teruo Takeuchi, Kitakyushu (JP)

(73) Assignee: **Kabushiki Kaisha Toshiba**, Minato-ku,
Tokyo (JP)

(*) Notice: This patent is subject to a terminal disclaimer.

(**) Term: **14 Years**

(21) Appl. No.: **29/381,737**

(22) Filed: **Dec. 22, 2010**

(30) **Foreign Application Priority Data**

Sep. 29, 2010 (JP) 2010-023299

(51) **LOC (9) Cl.** **13-03**

(52) **U.S. Cl.** **D13/180**

(58) **Field of Classification Search** D13/180;
257/79, 80, 81, 88, 89, 95, 98, 99, 100, E33.058,
257/676, 678; 313/483, 498, 500; 362/555,
362/800

See application file for complete search history.

(56) **References Cited**

U.S. PATENT DOCUMENTS

D506,187 S *	6/2005	Wang et al.	D13/180
D509,809 S *	9/2005	Wang et al.	D13/180
D511,328 S *	11/2005	Wang et al.	D13/180
7,242,076 B2 *	7/2007	Dolan 257/666	
D576,571 S *	9/2008	Itai D13/180	

D599,303 S *	9/2009	Seo et al.	D13/180
7,709,754 B2 *	5/2010	Doogue et al.	174/528
7,714,334 B2 *	5/2010	Lin 257/81	
7,759,775 B2 *	7/2010	Sun et al.	257/666
7,868,432 B2 *	1/2011	Lee et al.	257/676
2004/0000702 A1 *	1/2004	Knapp et al.	257/666
2005/0248336 A1 *	11/2005	Sharma et al.	324/117 H
2006/0145318 A1 *	7/2006	Zhang et al.	257/676
2006/0214273 A1 *	9/2006	Wang et al.	257/678
2009/0174048 A1 *	7/2009	Liu et al.	257/676
2009/0278241 A1 *	11/2009	Liu et al.	257/676
2010/0032819 A1 *	2/2010	Liu et al.	257/676

FOREIGN PATENT DOCUMENTS

JP	D1322677	2/2008
JP	D1375900	12/2009
KR	30-0379639	4/2005
KR	30-0379641	4/2005
KR	30-0379641-01	6/2005

* cited by examiner

Primary Examiner — Selina Sikder

(74) *Attorney, Agent, or Firm* — Banner & Witcoff, Ltd

(57) **CLAIM**

The ornamental design for a light-emitting diode, as shown and described.

DESCRIPTION

FIG. 1 is a front perspective view of a light-emitting diode, showing our new design;
FIG. 2 is a rear perspective view thereof;
FIG. 3 is a front elevational view thereof;
FIG. 4 is a rear elevational view thereof;
FIG. 5 is a top plan view thereof;
FIG. 6 is a bottom plan view thereof;
FIG. 7 is a right side elevational view thereof; and,
FIG. 8 is a left side elevational view thereof.

1 Claim, 6 Drawing Sheets

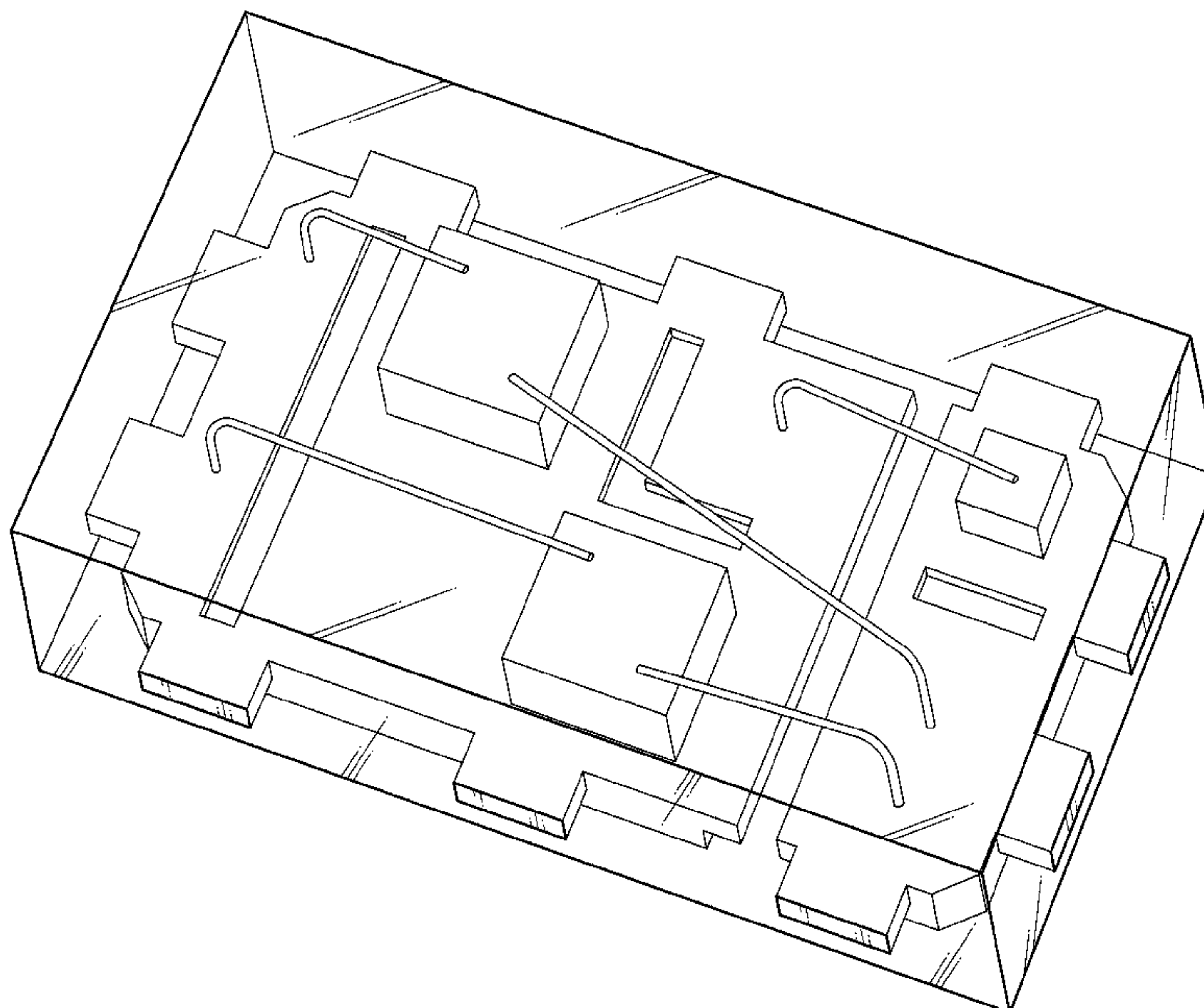

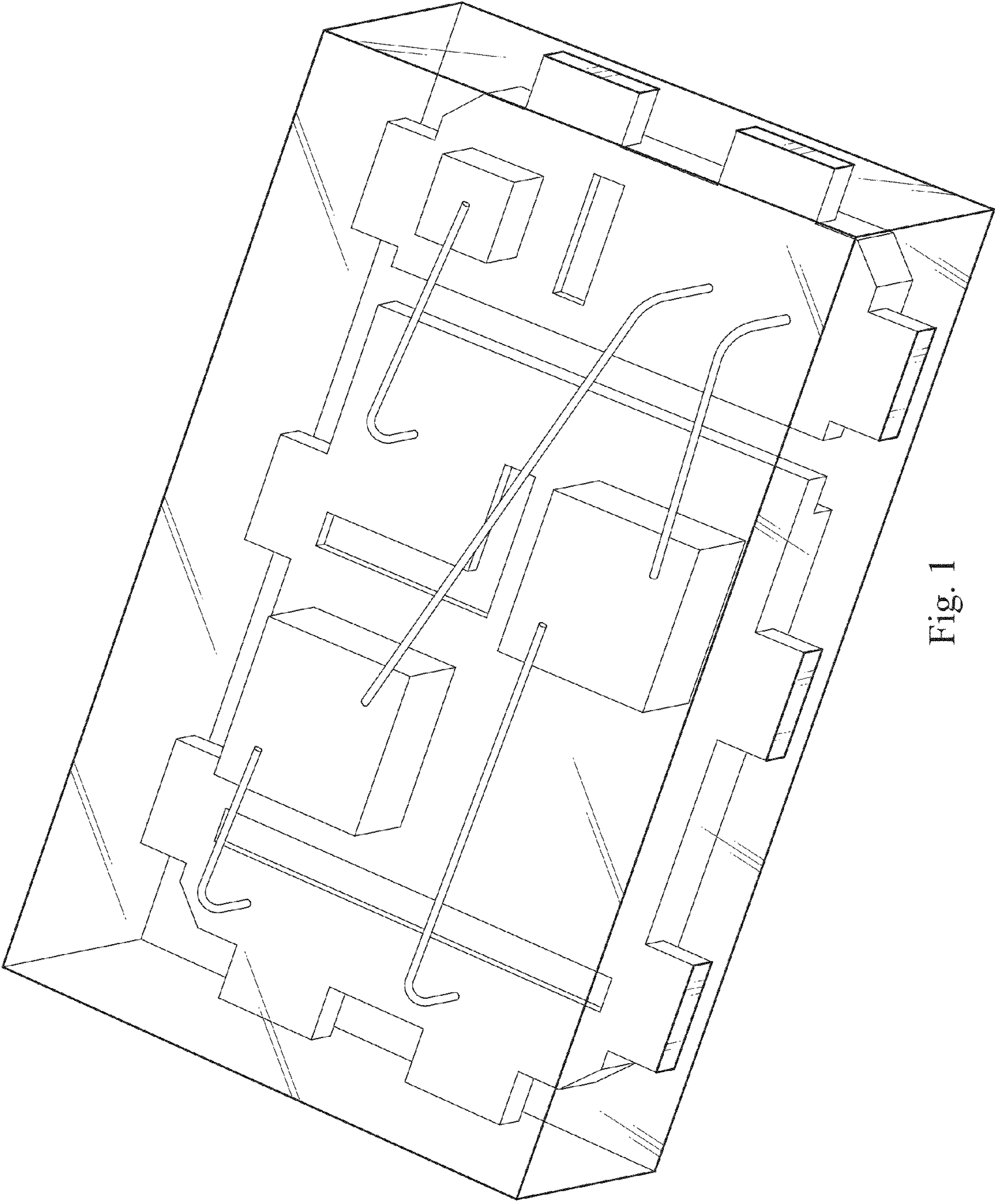

Fig. 1

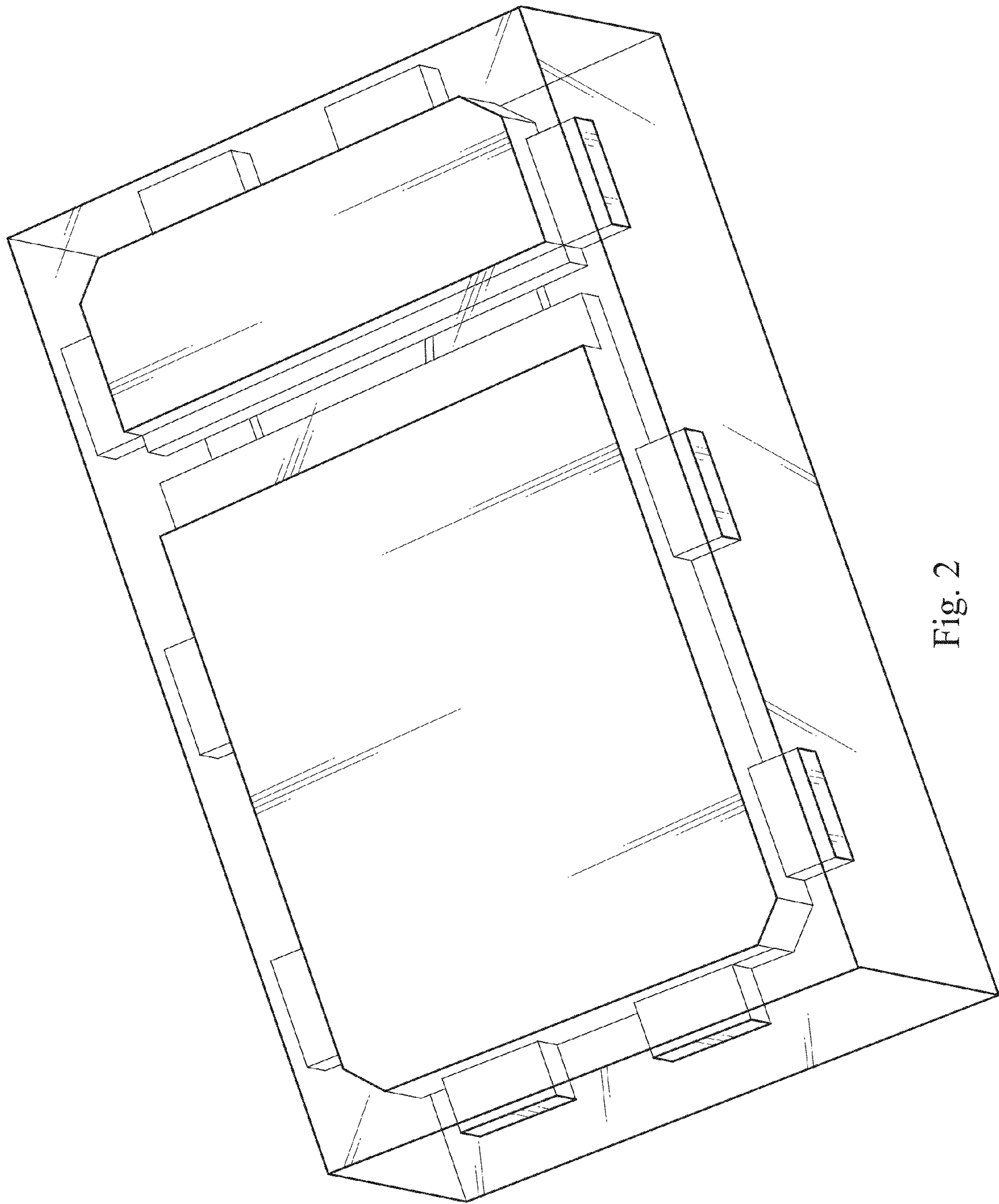

Fig. 2

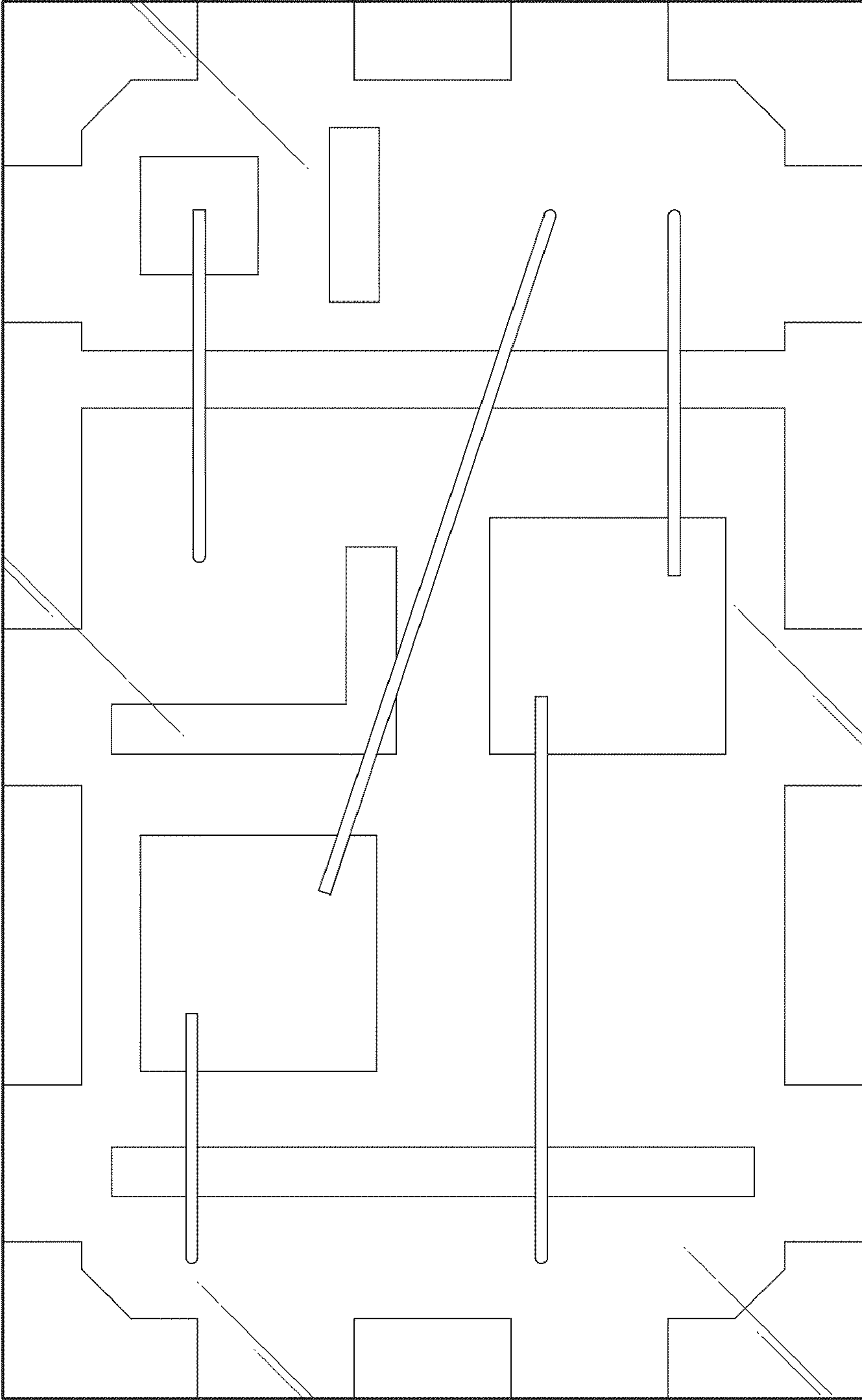

Fig. 3

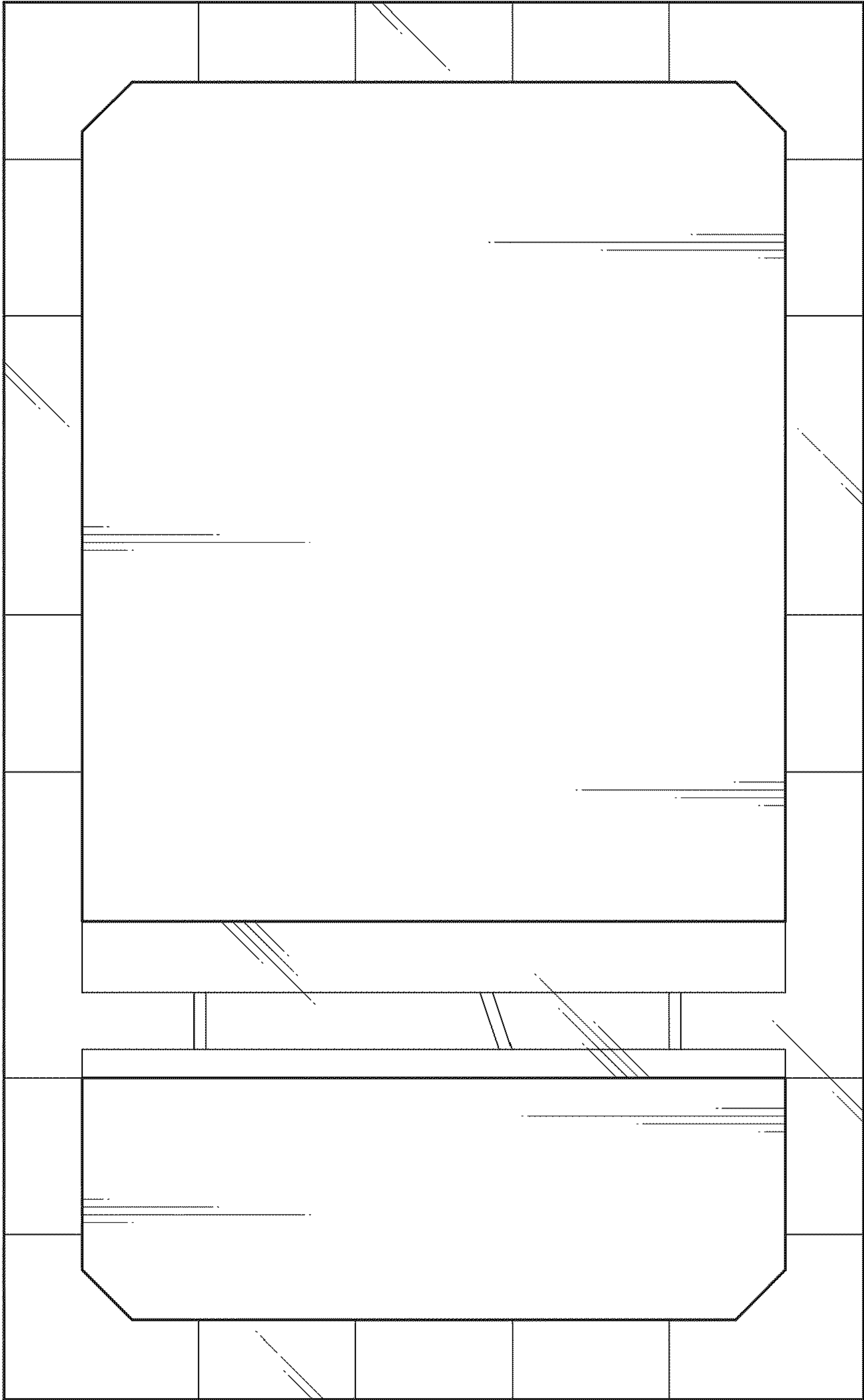

Fig. 4

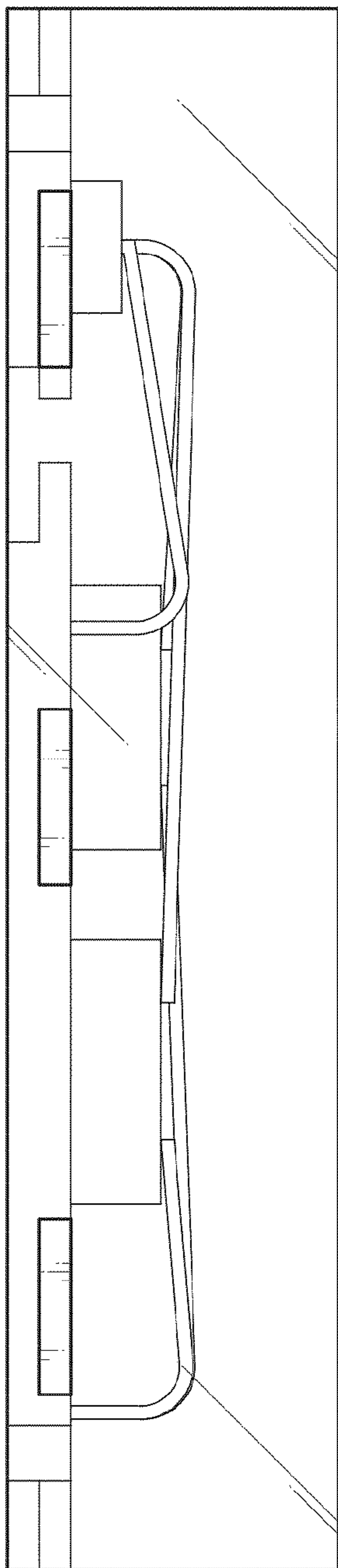

Fig. 5

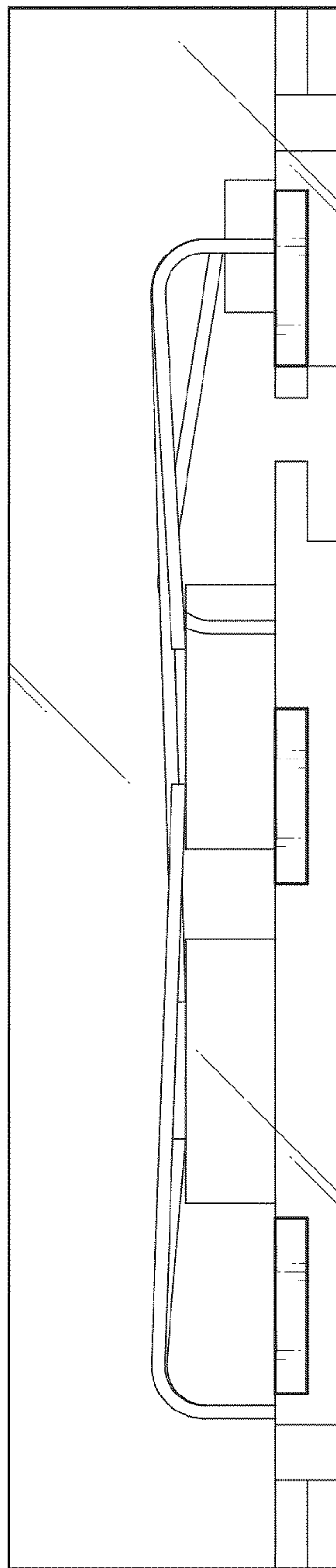

Fig. 6

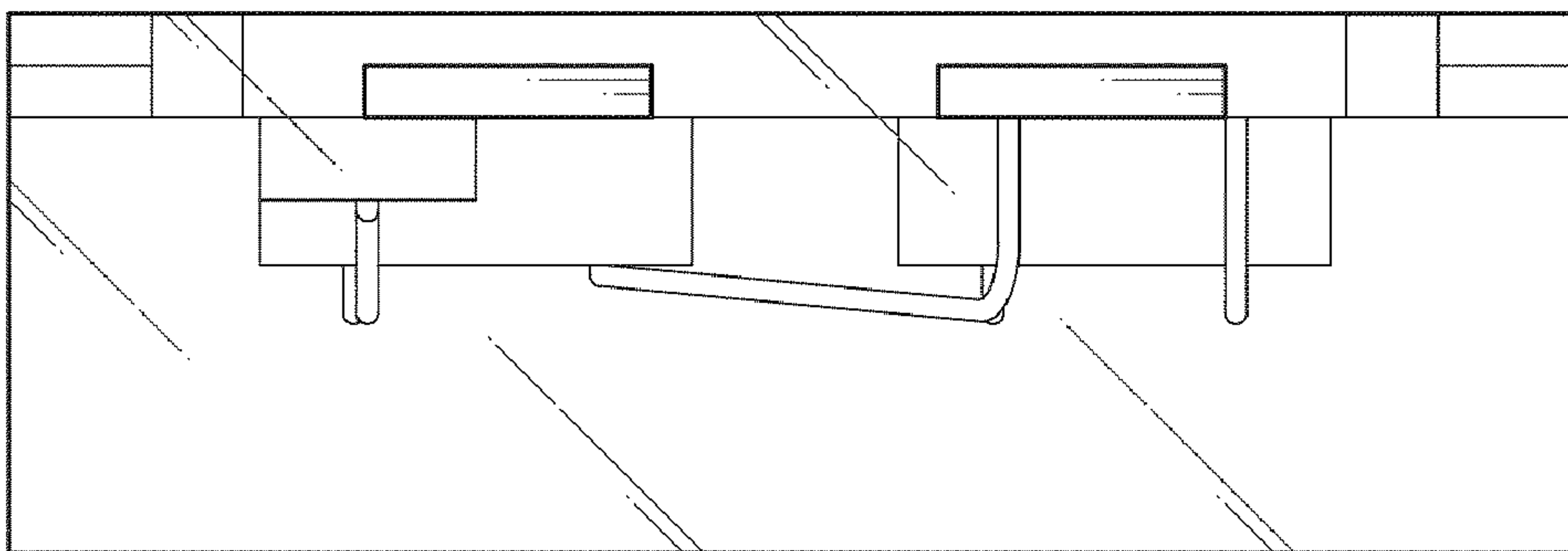

Fig. 7

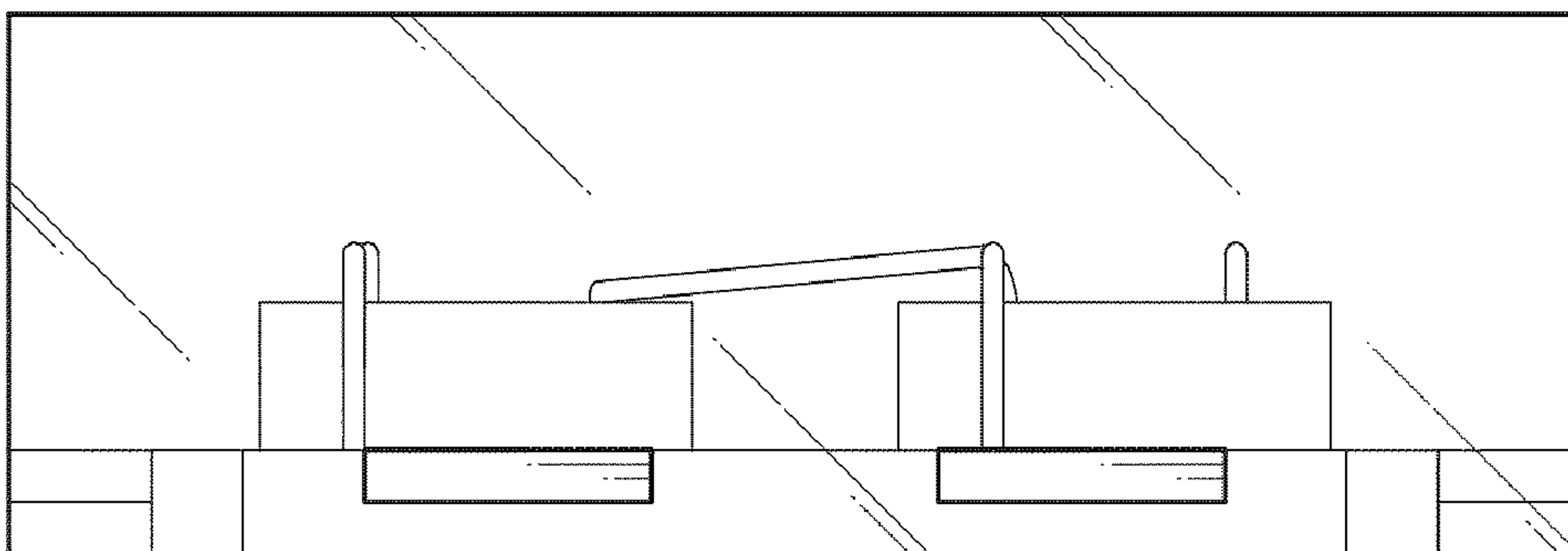

Fig. 8