



US00D649882S

(12) **United States Design Patent**
Fleischhacker et al.

(10) **Patent No.:** **US D649,882 S**

(45) **Date of Patent:** **** Dec. 6, 2011**

(54) **CONTAINER BODY PORTION**

(75) Inventors: **Kyle Fleischhacker**, Brownstown, MI (US); **James C. Dorn**, Sterling, OH (US)

(73) Assignee: **Plastipak Packaging, Inc.**, Plymouth, MI (US)

(**) Term: **14 Years**

(21) Appl. No.: **29/377,342**

(22) Filed: **Oct. 20, 2010**

(51) **LOC (9) Cl.** **09-01**

(52) **U.S. Cl.** **D9/531; D9/516**

(58) **Field of Classification Search** D9/516, D9/530, 531, 537, 538, 540, 543, 550, 563, D9/571, 572, 575; D23/211.1, 211.2, 212; 215/381-385; 220/660, 669, 679, 752

See application file for complete search history.

(56) **References Cited**

U.S. PATENT DOCUMENTS

D223,806 S *	6/1972	Beaver	D9/531
D329,816 S *	9/1992	Beaver et al.	D9/528
D371,740 S *	7/1996	Lathrop et al.	D9/528
D462,011 S *	8/2002	Walther et al.	D9/528
D513,702 S *	1/2006	Ferguson et al.	D9/528
D529,808 S *	10/2006	Schmidt et al.	D9/528
D531,908 S *	11/2006	Mayers	D9/531
D539,152 S *	3/2007	Brauner et al.	D9/528
D545,681 S *	7/2007	Cardinal et al.	D9/528
D551,556 S	9/2007	Kaminski		
D557,141 S	12/2007	Pedmo		

D559,692 S *	1/2008	Floyd et al.	D9/531
D578,397 S	10/2008	Caldwell		
D578,897 S	10/2008	Caldwell		
D591,601 S	5/2009	Miller		
D592,959 S	5/2009	Caldwell		
D594,749 S	6/2009	Caldwell		
D595,588 S	7/2009	Caldwell		
D599,210 S	9/2009	Caldwell		
D603,269 S	11/2009	Miller		
D610,909 S	3/2010	Caldwell		
D622,599 S	8/2010	Caldwell		
D644,528 S *	9/2011	Dorn	D9/528

* cited by examiner

Primary Examiner — Stella Reid

Assistant Examiner — Keli L Hill

(74) *Attorney, Agent, or Firm* — Mario A. Tabone

(57) **CLAIM**

The ornamental design for a container body portion, as shown and described.

DESCRIPTION

FIG. 1 is a top, rear, left perspective view of a container body portion showing our new design;

FIG. 2 is a front elevational view thereof;

FIG. 3 is a rear elevational view thereof;

FIG. 4 is a left elevational view thereof;

FIG. 5 is a right elevational view thereof;

FIG. 6 is a top plan view thereof; and,

FIG. 7 is a bottom plan view thereof.

The broken lines shown are included for the purpose of illustrating the unclaimed portions of the article and form no part of the claim.

1 Claim, 7 Drawing Sheets

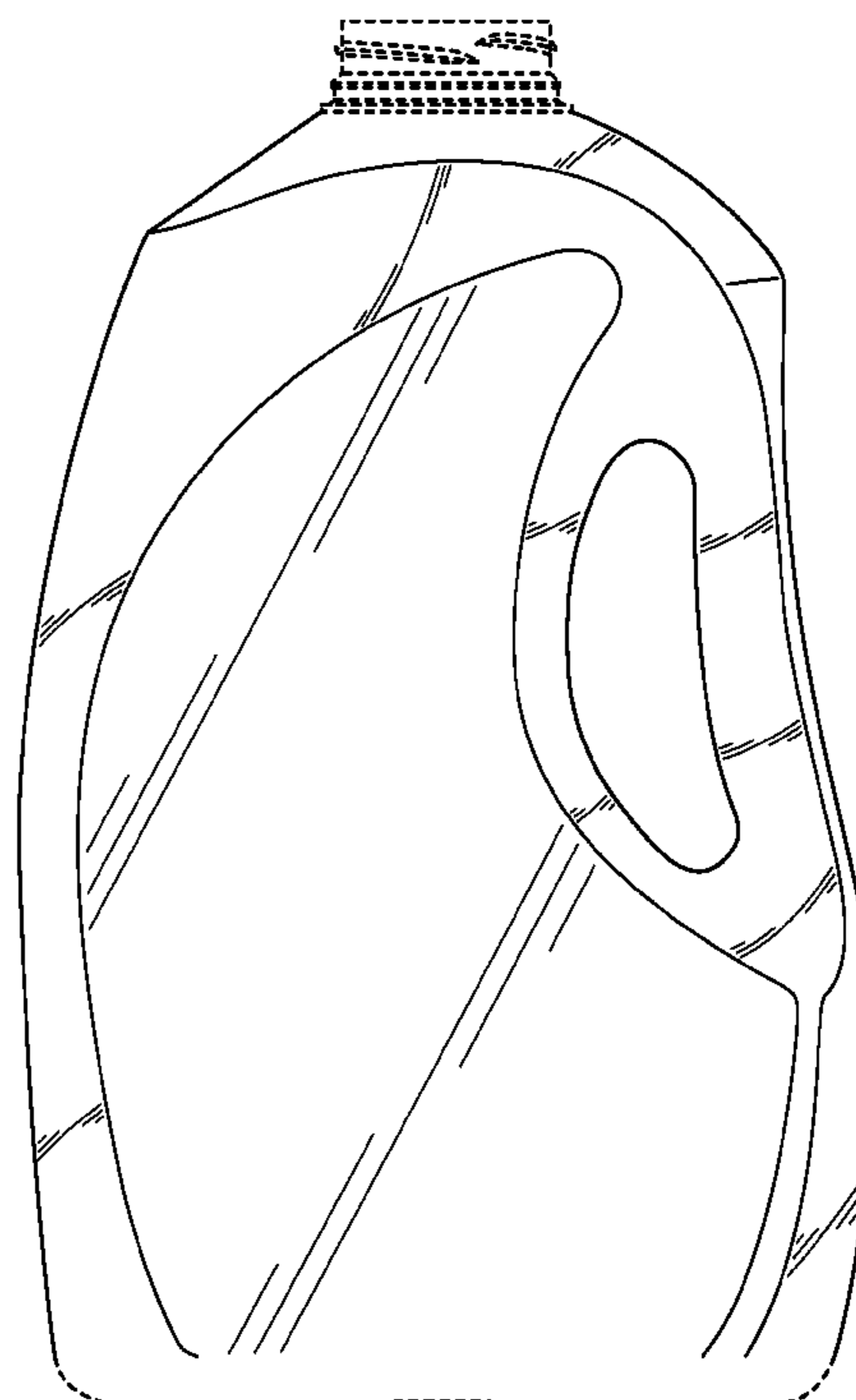
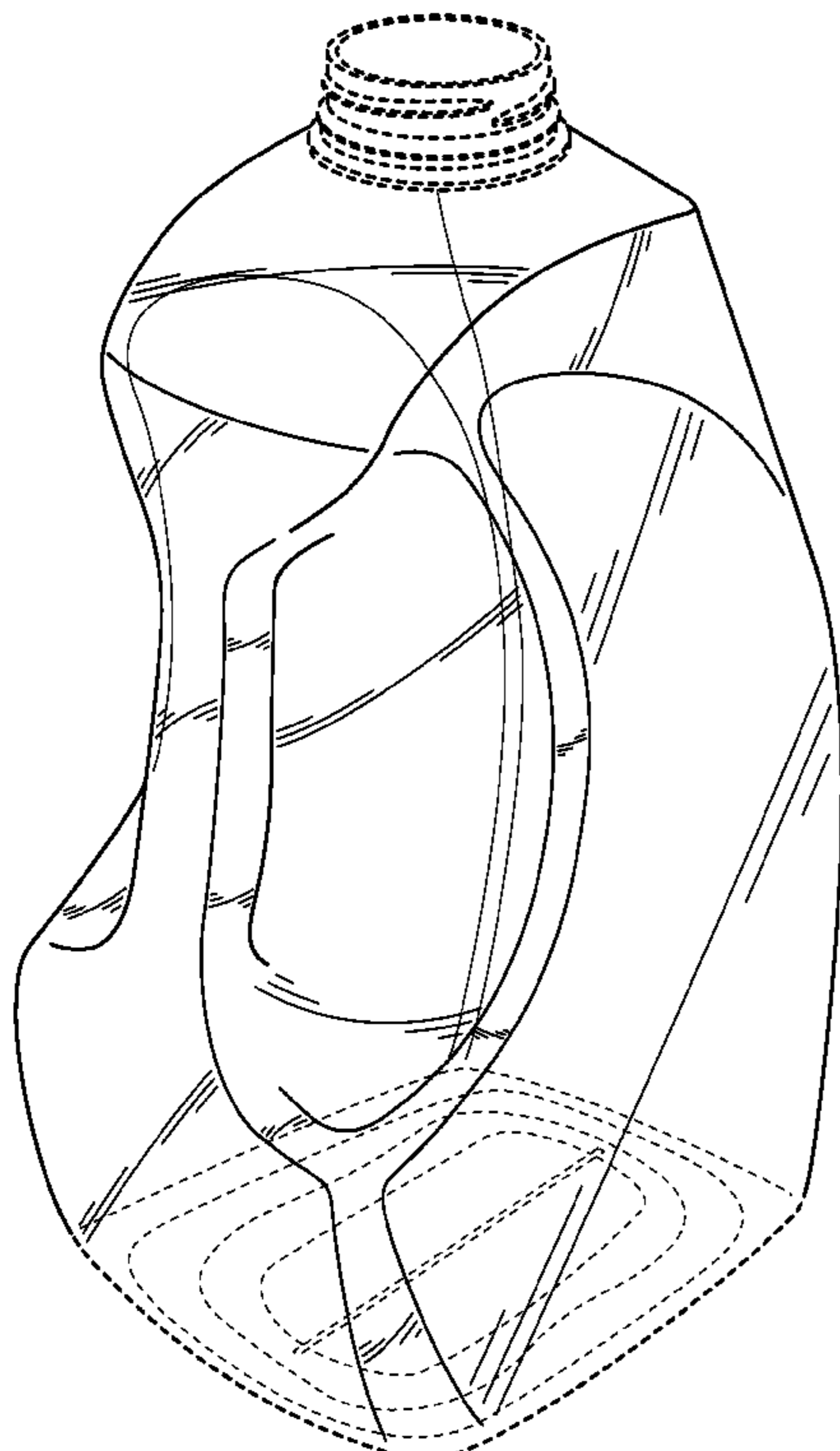

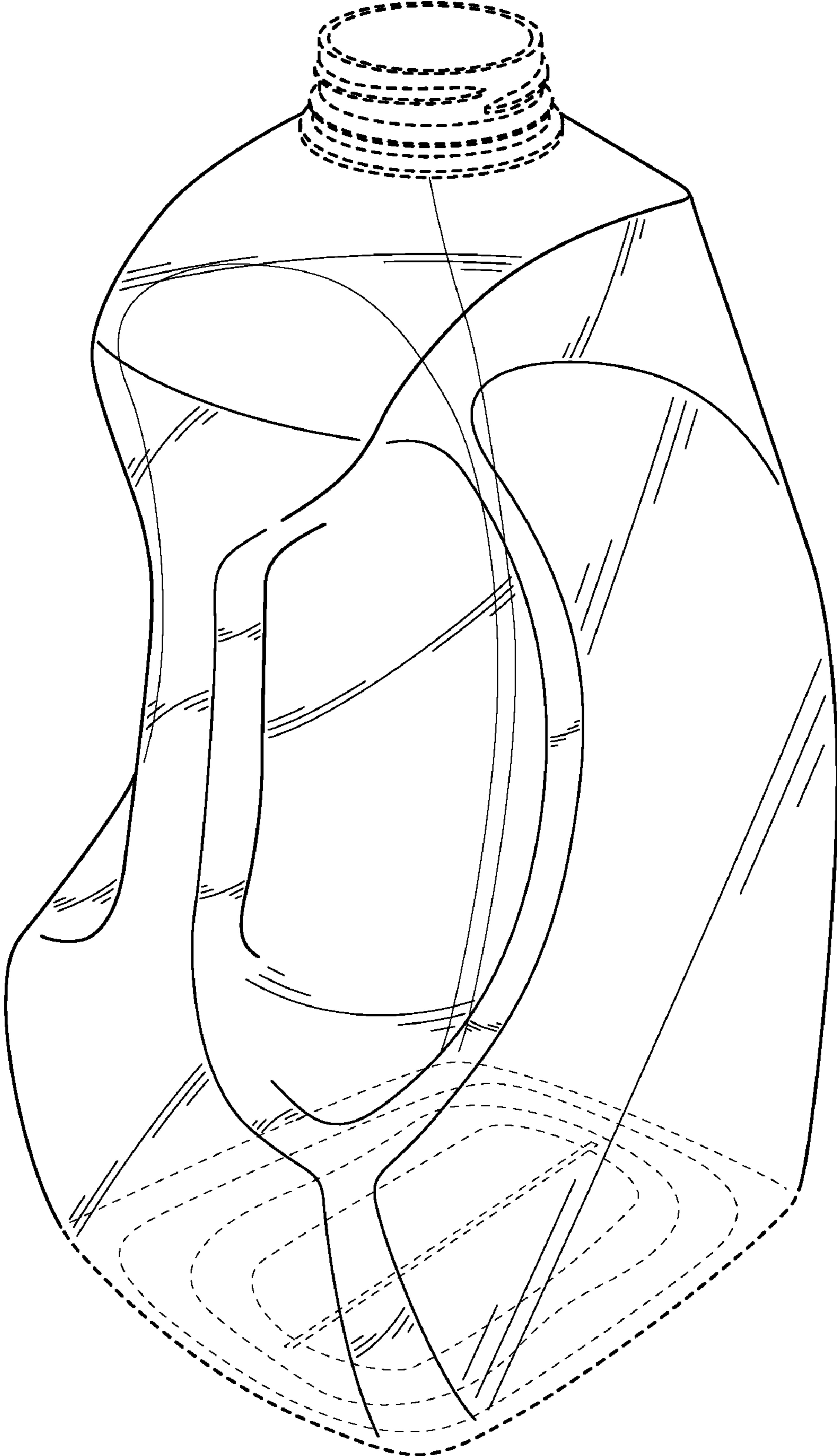

FIG. 1

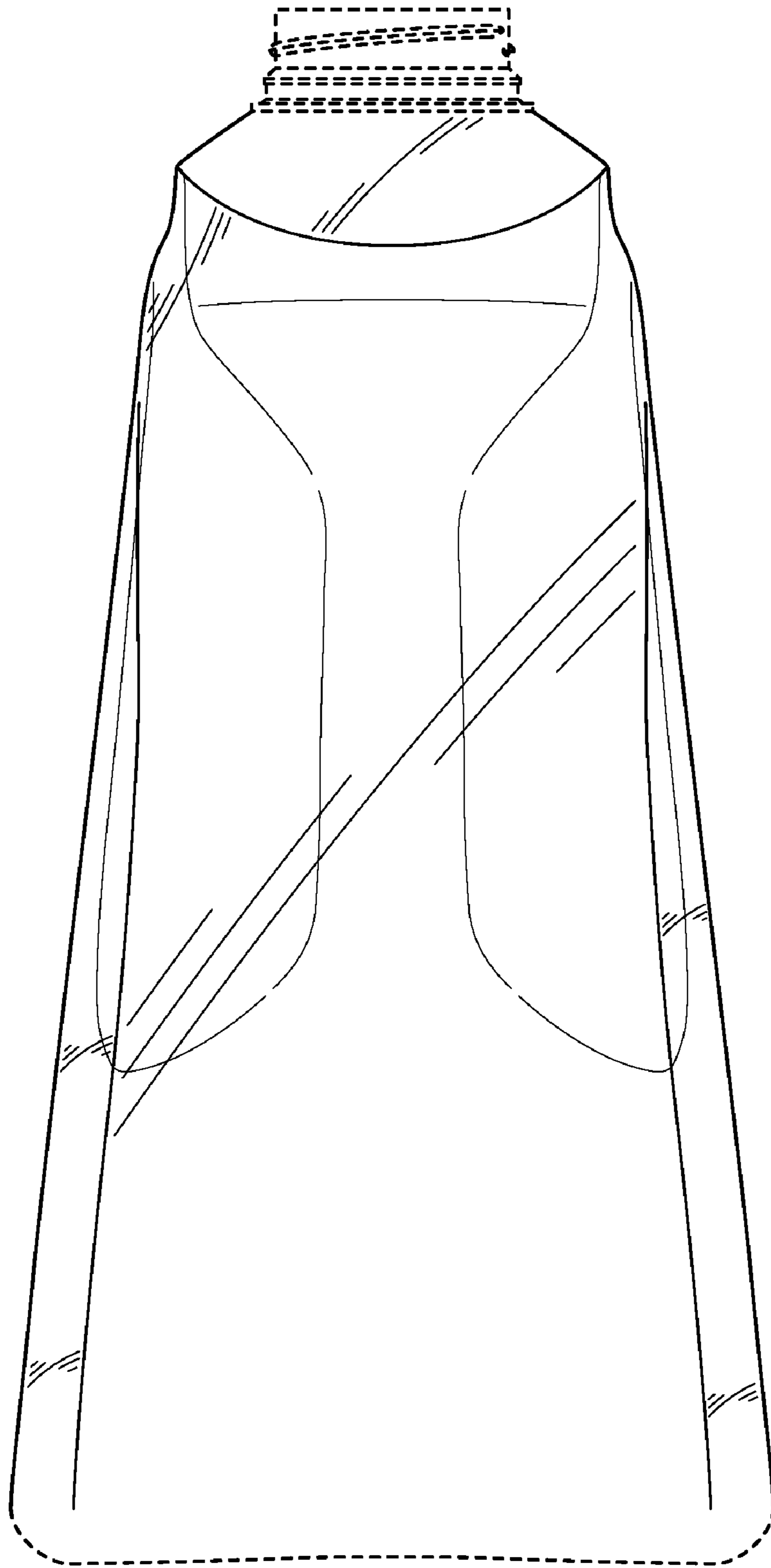

FIG. 2

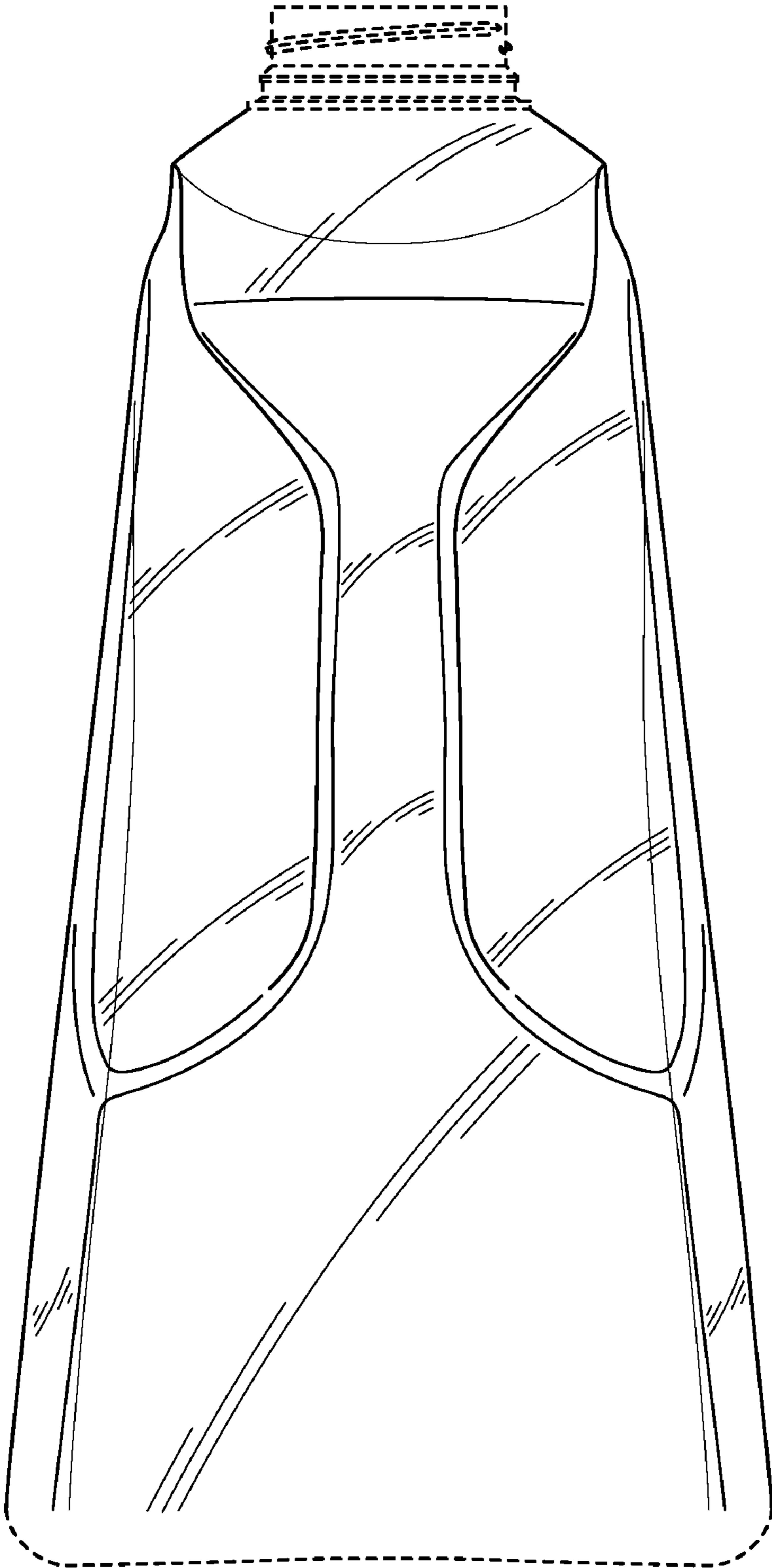

FIG. 3

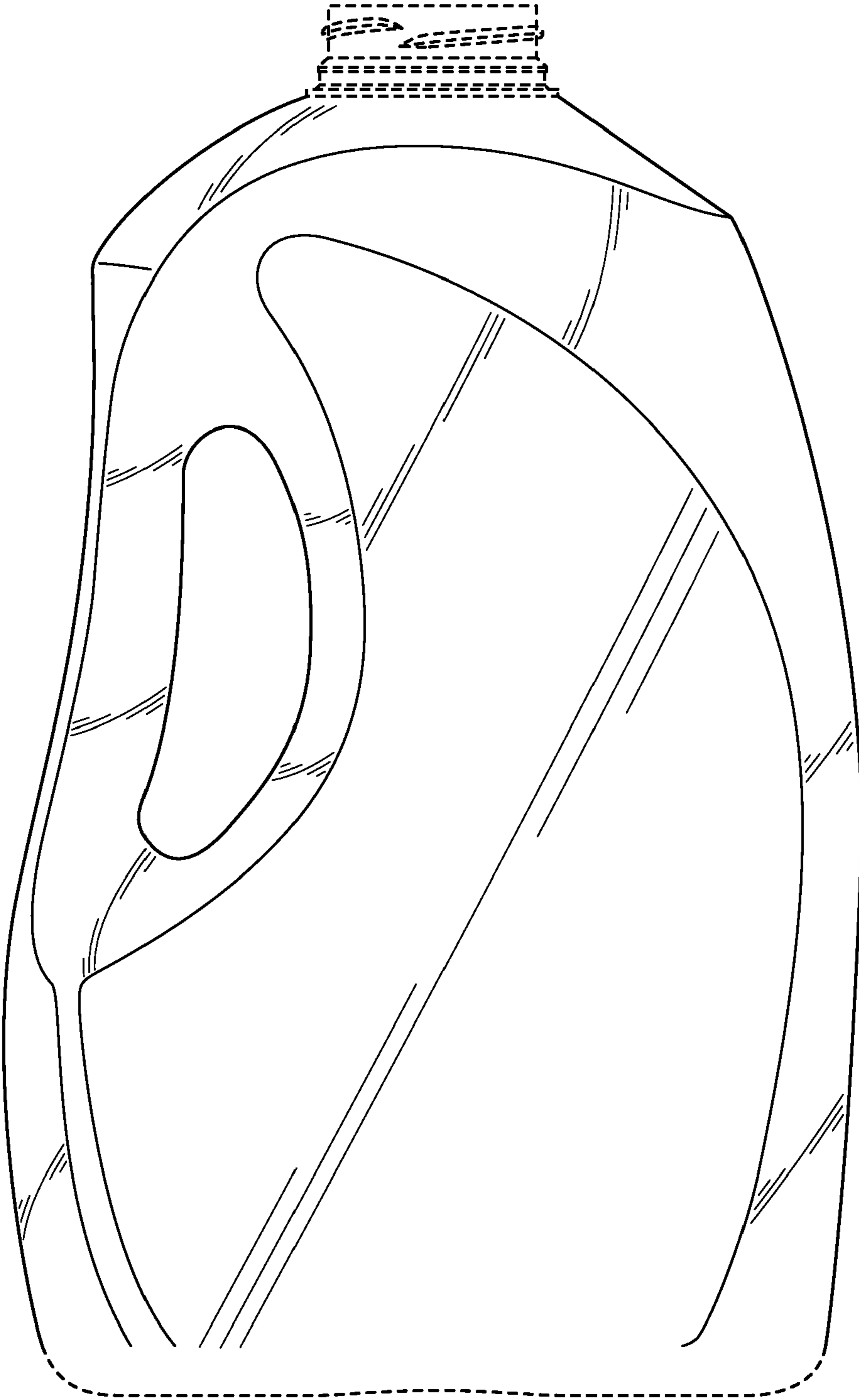

FIG. 4

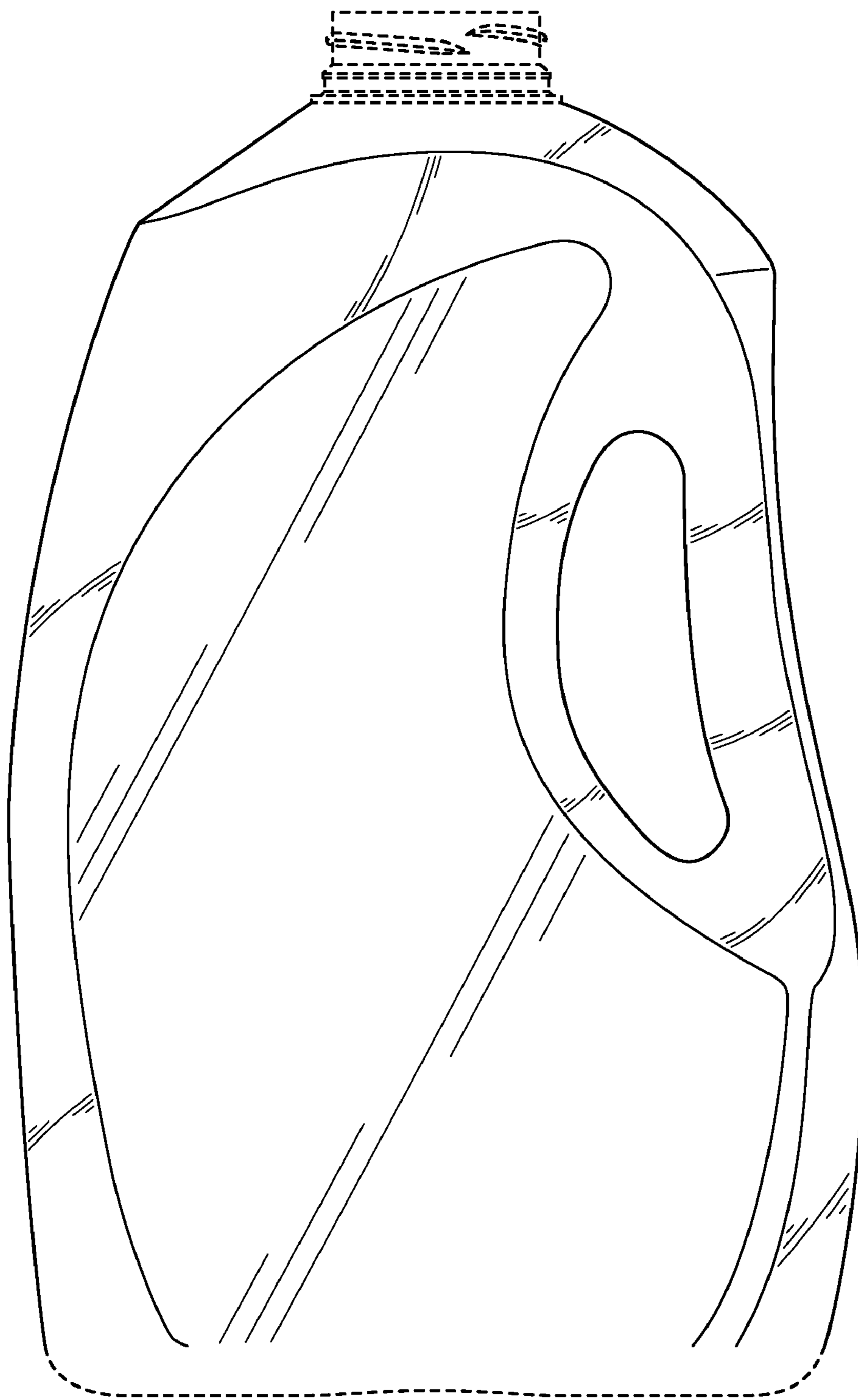

FIG. 5

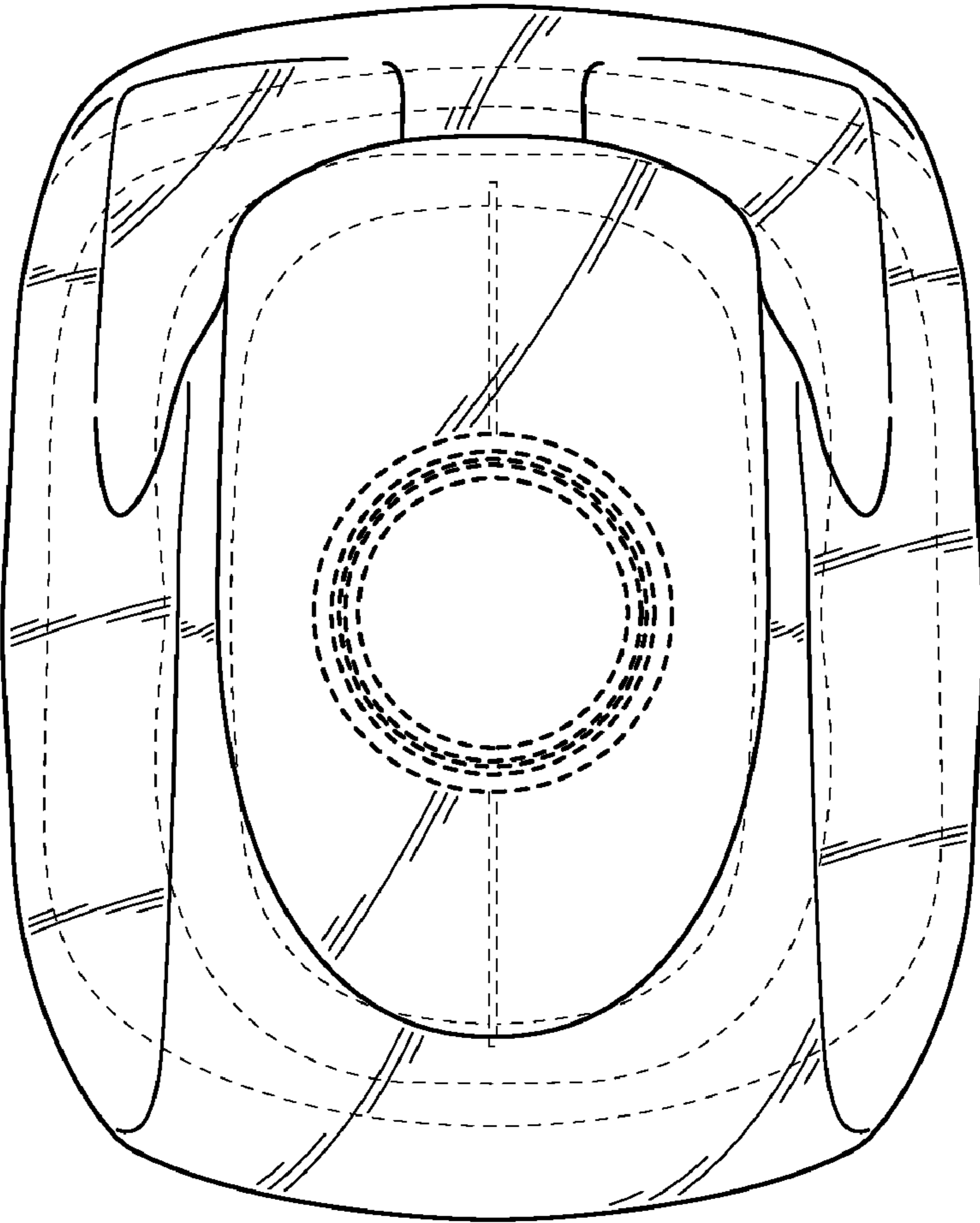

FIG. 6

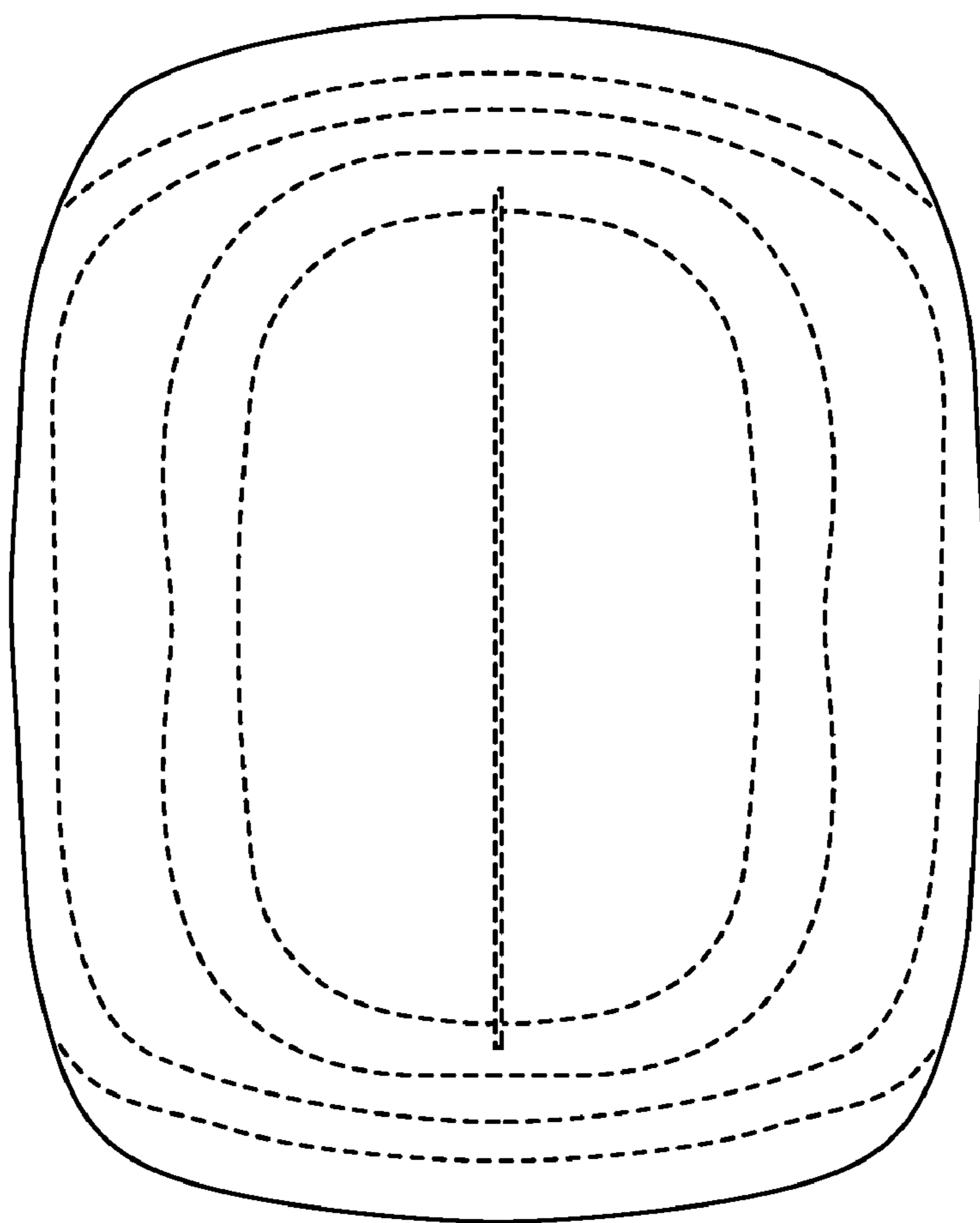

FIG. 7