



US00D649836S

(12) **United States Design Patent**
Dooley et al.

(10) **Patent No.:** **US D649,836 S**
(45) **Date of Patent:** **** Dec. 6, 2011**

(54) **CUP WITH INNER ICE COMPARTMENT WITH LID**

(76) Inventors: **Thomas M. Dooley**, Taunton, MA (US);
Kathleen Dooley, Taunton, MA (US)

(**) Term: **14 Years**

(21) Appl. No.: **29/365,370**

(22) Filed: **Jul. 8, 2010**

(51) **LOC (9) Cl.** **07-01**

(52) **U.S. Cl.** **D7/536; D7/507**

(58) **Field of Classification Search** D7/536,
D7/533, 523, 509, 507; 220/592.17, 662;
215/386, 376

See application file for complete search history.

6,276,163	B1	8/2001	Broadbent	
6,283,606	B1 *	9/2001	Wei et al.	362/119
D454,033	S *	3/2002	Miller et al.	D7/514
D462,577	S *	9/2002	Miller et al.	D7/514
6,443,589	B1 *	9/2002	Lee	362/101
6,467,644	B1 *	10/2002	Yeh	220/592.17
6,502,418	B2 *	1/2003	Holley, Jr.	62/457.3
D475,577	S *	6/2003	Kung	D7/507
6,868,694	B2	3/2005	Nielsen	
7,010,935	B2	3/2006	Citrynell et al.	
D551,904	S *	10/2007	Rouso et al.	D7/510
D635,400	S *	4/2011	Snyder	D7/536

* cited by examiner

Primary Examiner — Marianne Pandozzi

(57) **CLAIM**

The ornamental design for a cup with inner ice compartment with lid, as shown and described.

(56) **References Cited**

U.S. PATENT DOCUMENTS

1,561,730	A *	11/1925	Kodama	40/324
4,040,549	A *	8/1977	Sadler	224/483
4,563,726	A *	1/1986	Newcomb et al.	362/34
D293,642	S	1/1988	Rubbright, III et al.	
4,922,355	A *	5/1990	Dietz et al.	362/101
D308,456	S *	6/1990	Kalamaras et al.	D7/515
5,123,190	A *	6/1992	Erberber	40/324
D376,728	S *	12/1996	Richards et al.	D7/507
5,653,124	A	8/1997	Weber	
D396,384	S *	7/1998	Slaten et al.	D7/622
6,013,901	A *	1/2000	Lavoie	219/435
6,072,161	A *	6/2000	Stein	219/432
6,082,866	A *	7/2000	Amedee	362/34
6,173,581	B1	1/2001	Wyatt	

DESCRIPTION

FIG. 1 is a perspective view of a cup with inner ice compartment with lid showing my new design;
FIG. 2 is a front view thereof;
FIG. 3 is a back view thereof;
FIG. 4 is a side view thereof;
FIG. 5 is an opposite side view thereof;
FIG. 6 is a top view thereof; and,
FIG. 7 is a bottom view thereof.

The broken lines in the drawings are included for the purpose of illustration and form no part of the claimed design.

1 Claim, 7 Drawing Sheets

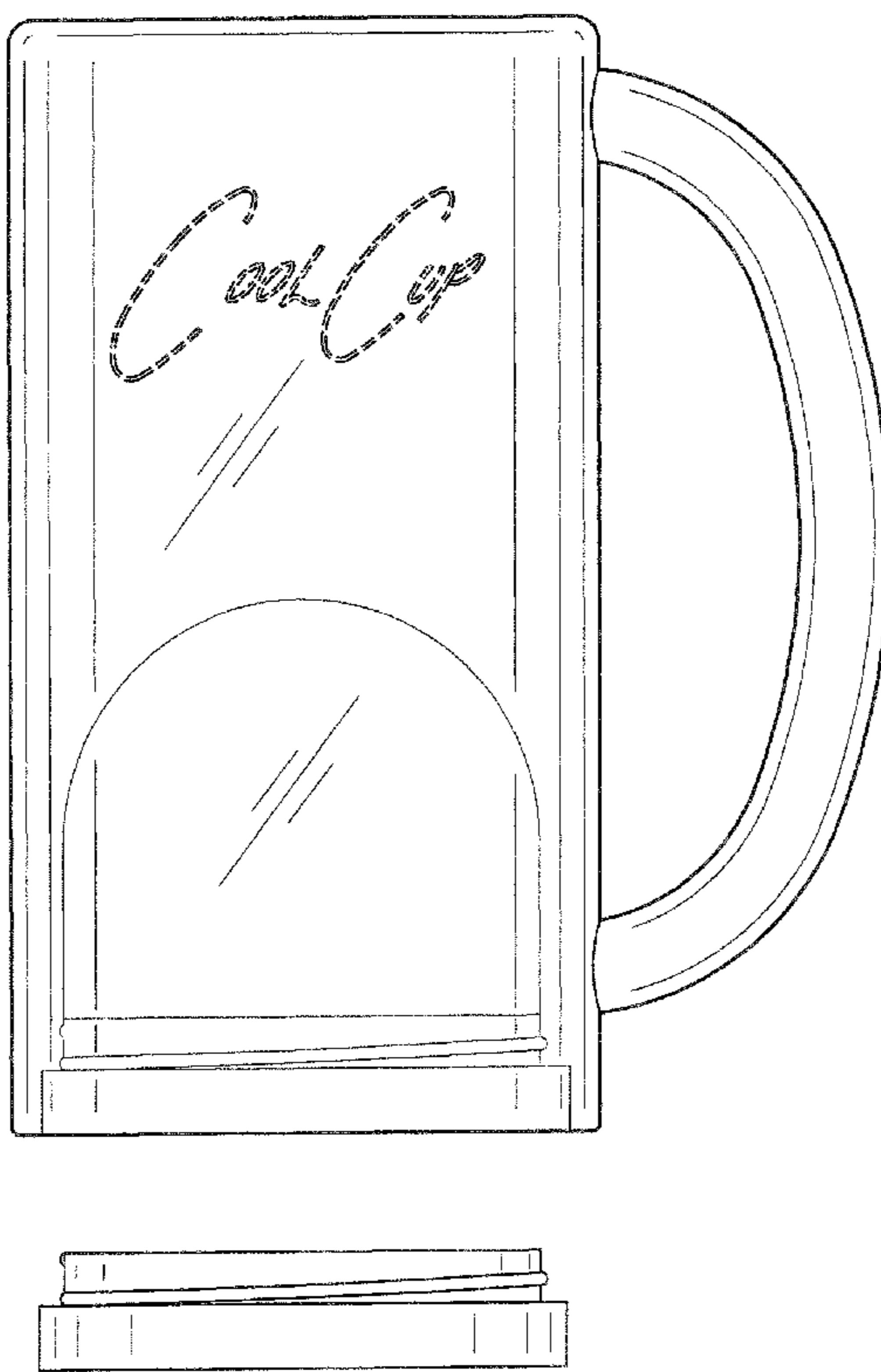

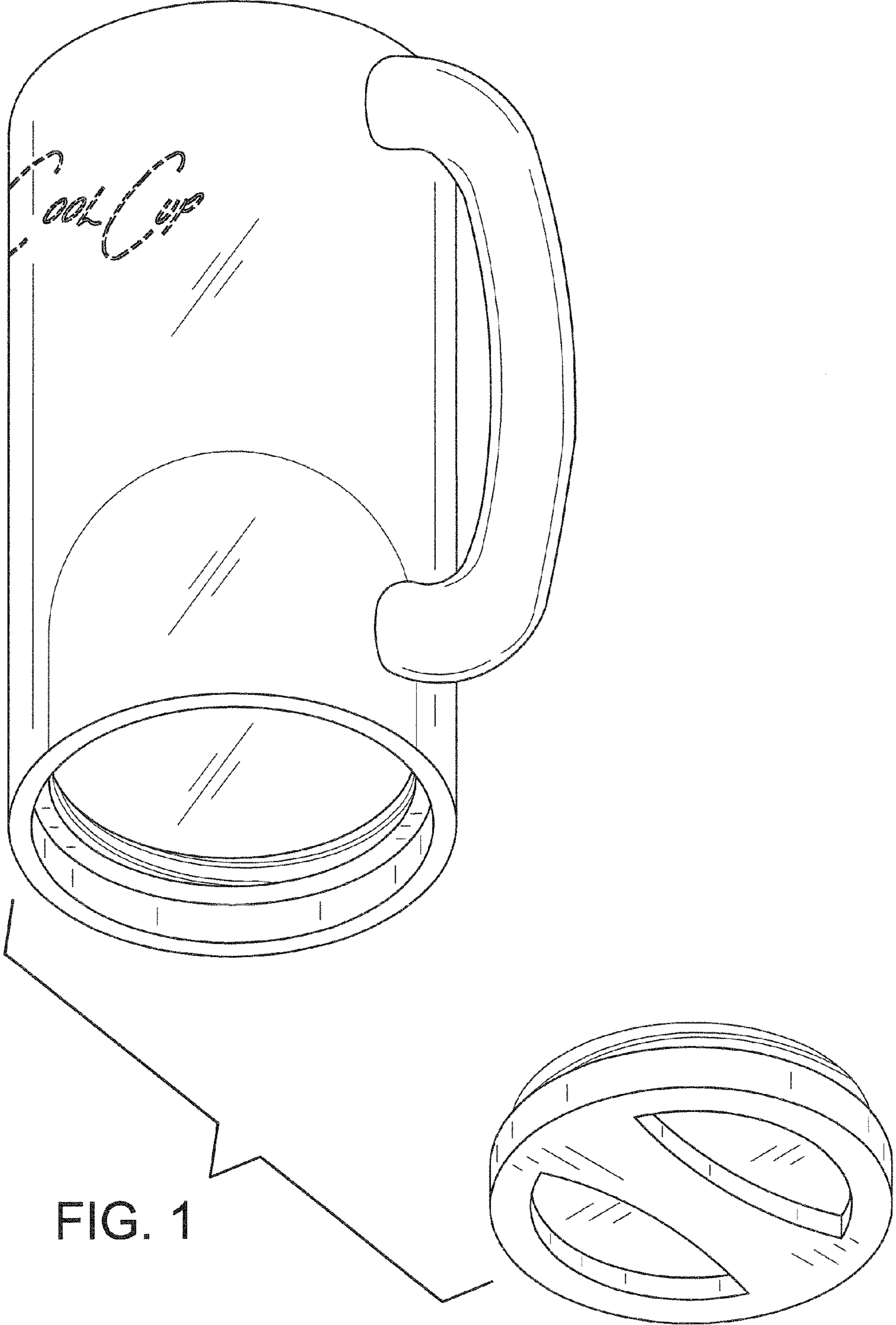
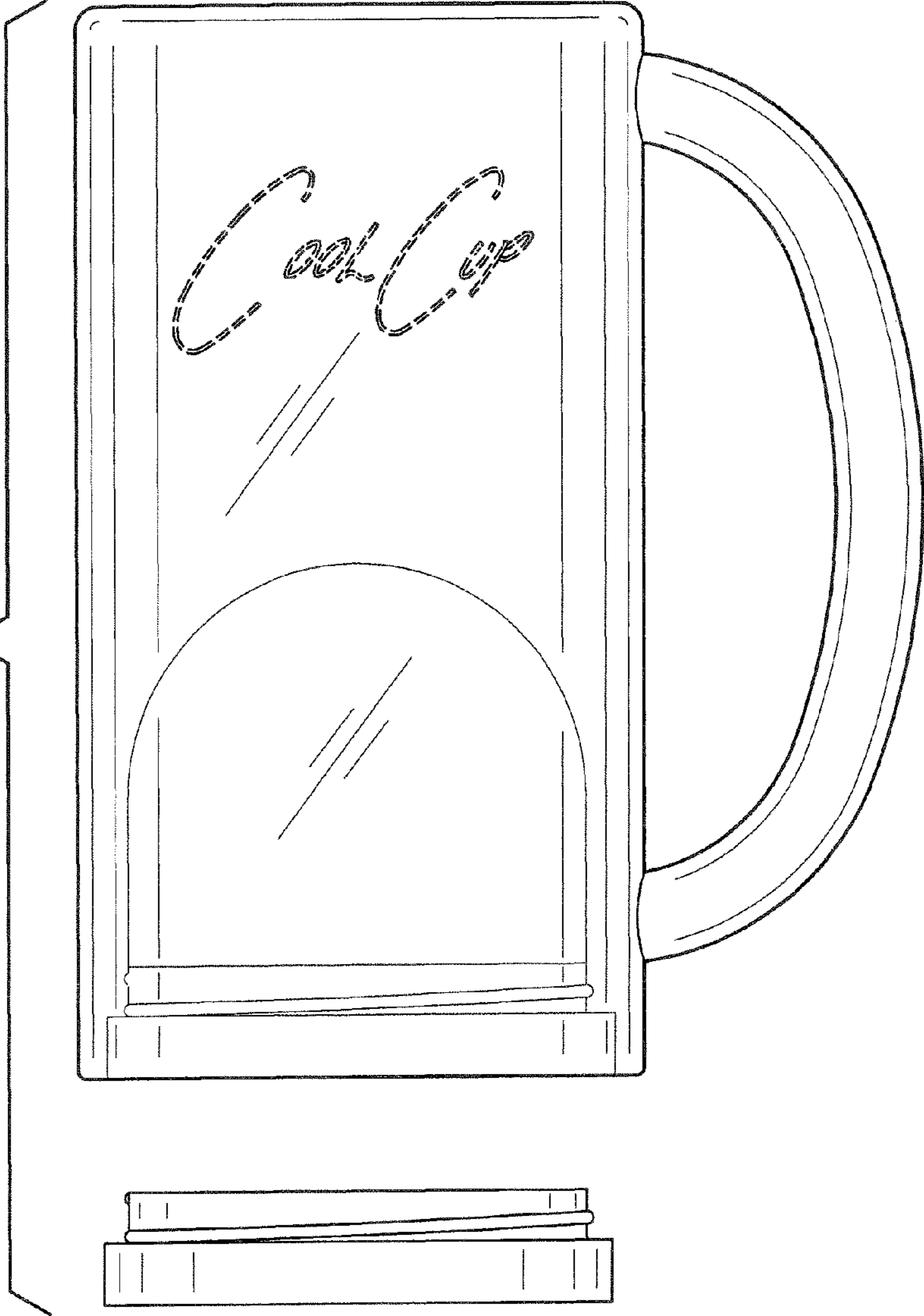

FIG. 1

FIG. 2



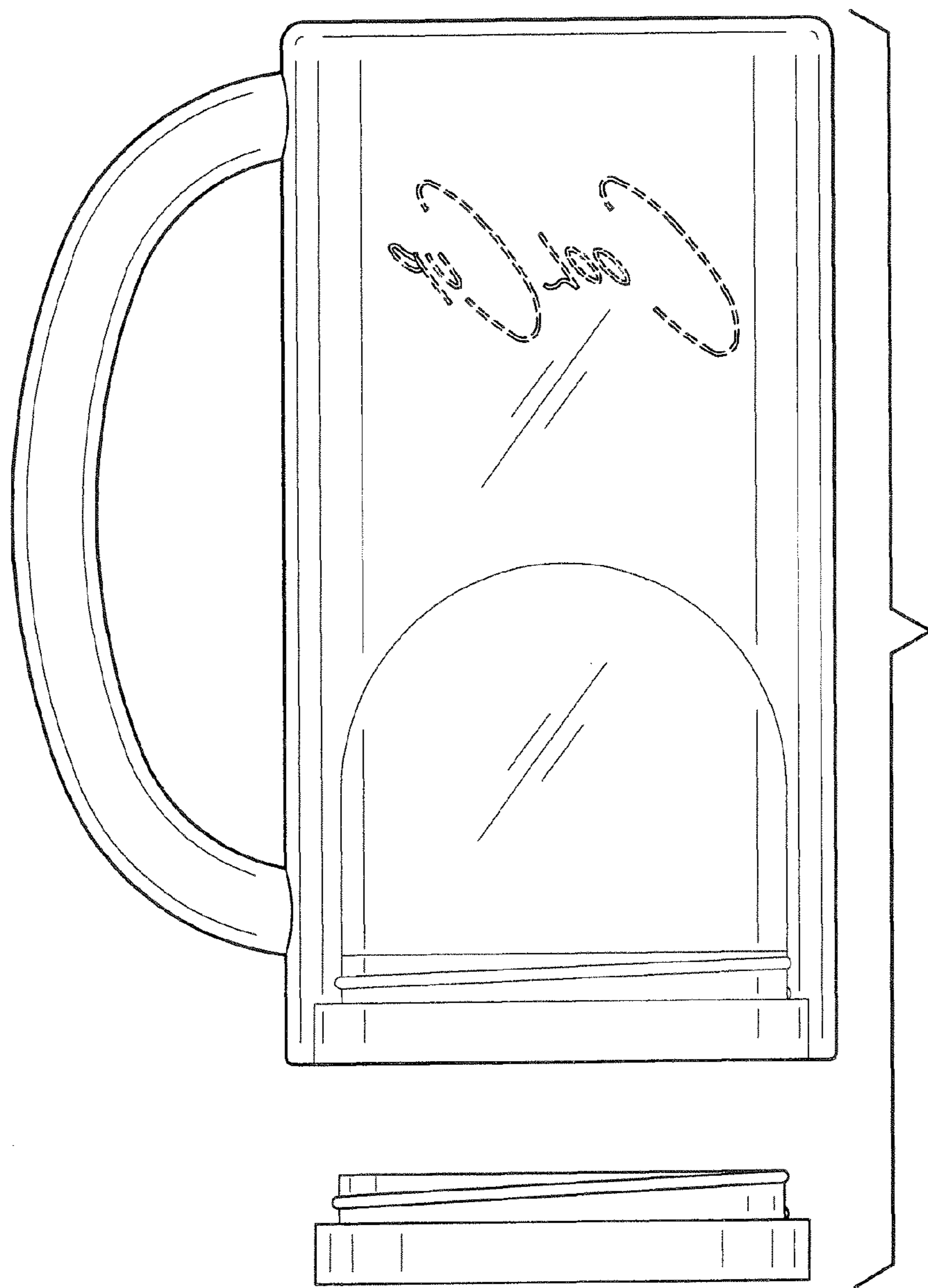

FIG. 3

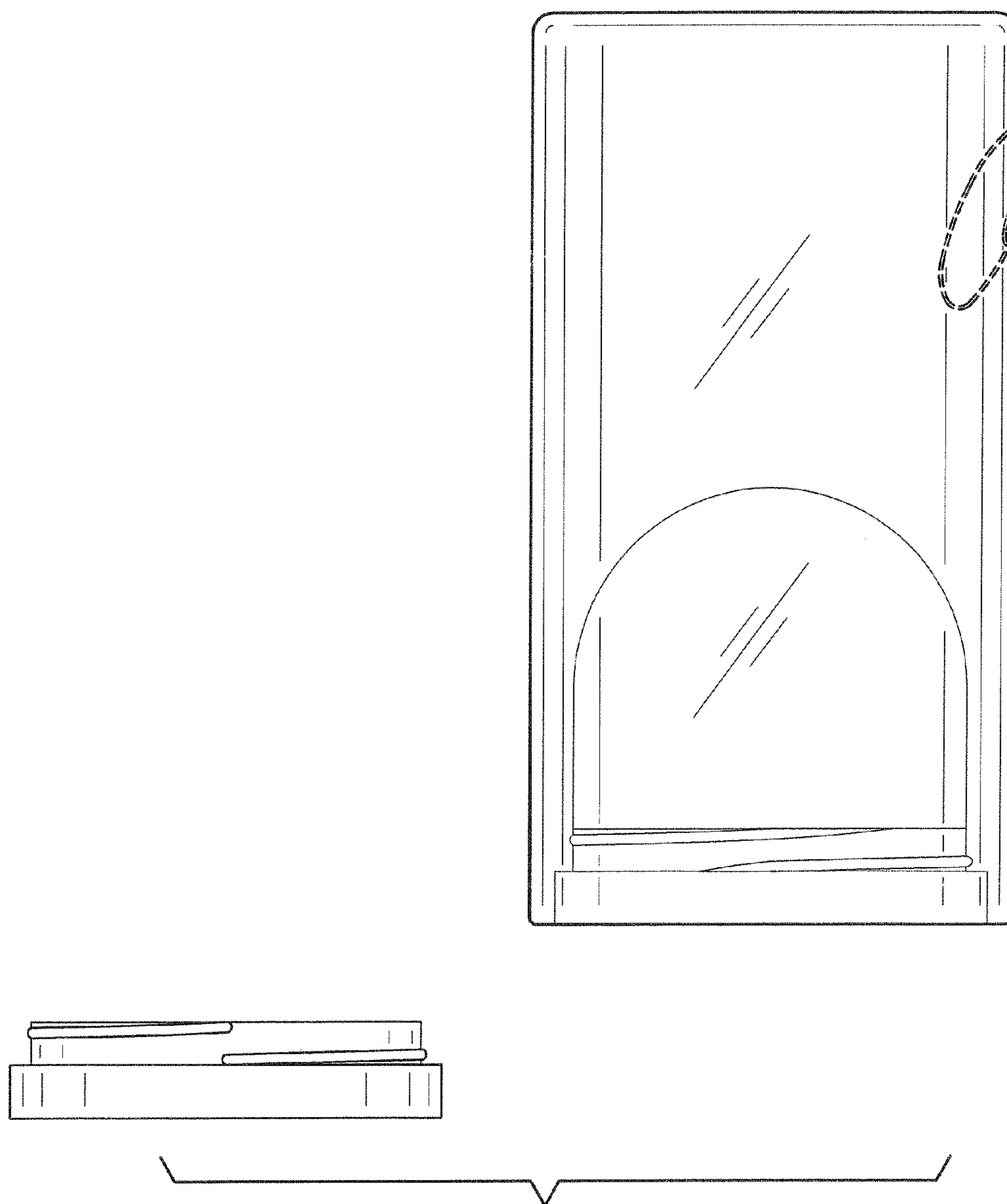

FIG. 4

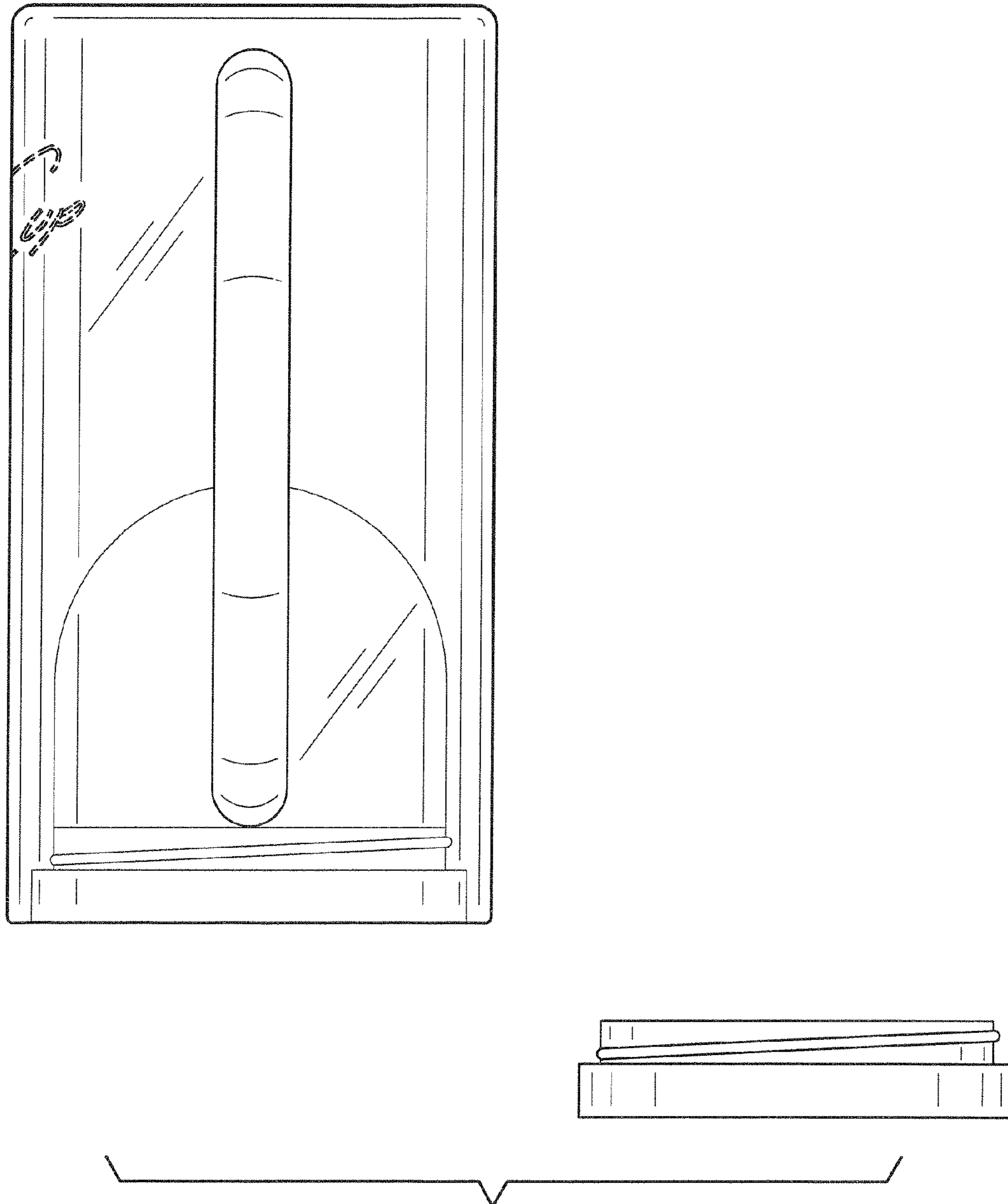

FIG. 5

FIG. 6

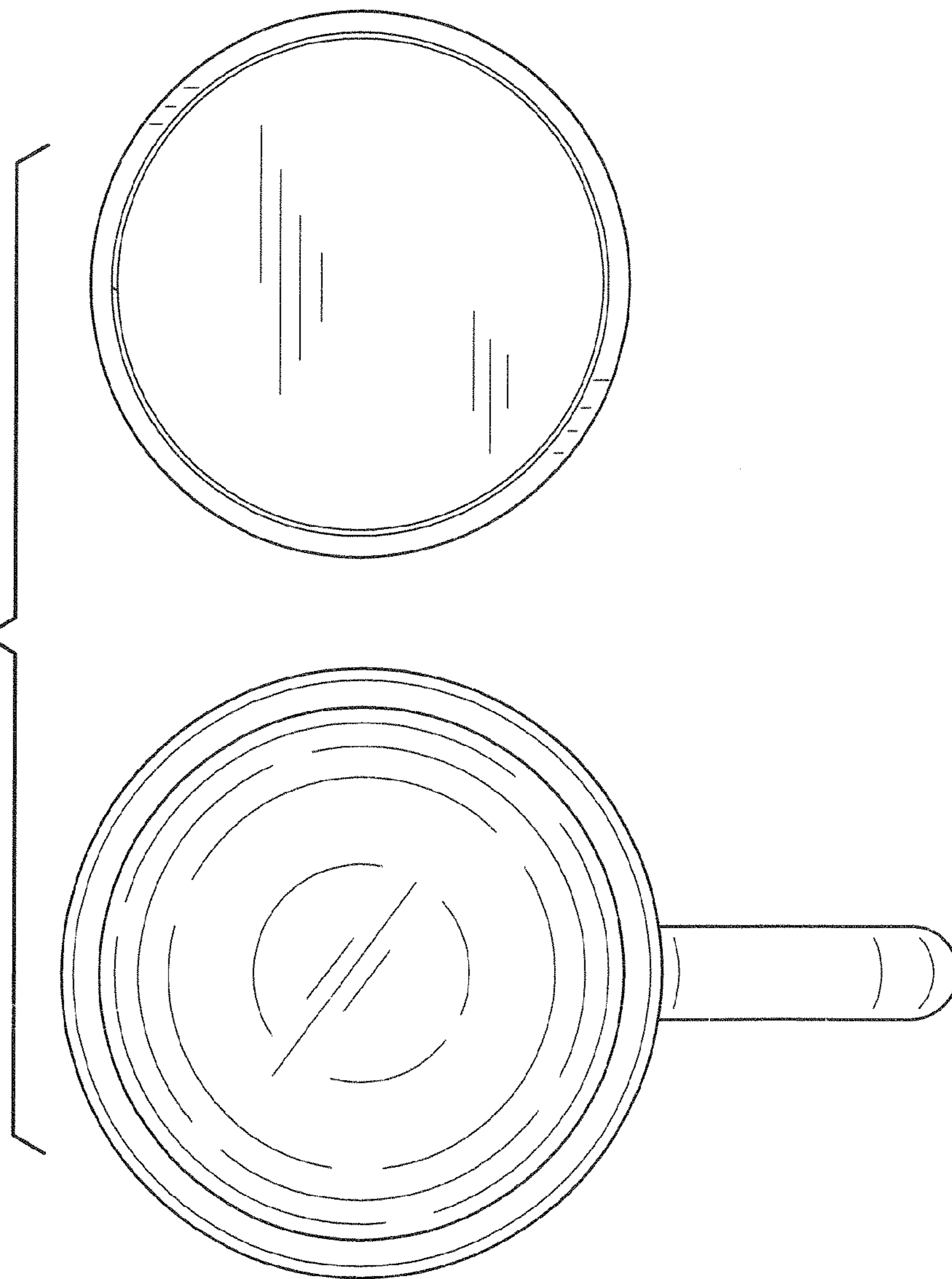

FIG. 7

