

US00D649772S

(12) **United States Design Patent**
Stewart

(10) **Patent No.:** **US D649,772 S**

(45) **Date of Patent:** **** Dec. 6, 2011**

(54) **ASSEMBLY OF SOCK COMPONENTS**

(75) Inventor: **Brandi A. Stewart**, Greensboro, NC
(US)

(73) Assignee: **Goldtoemoretz, L.L.C.**, New York, NY
(US)

(**) Term: **14 Years**

(21) Appl. No.: **29/343,502**

(22) Filed: **Sep. 14, 2009**

Related U.S. Application Data

(62) Division of application No. 29/266,278, filed on Sep. 18, 2006, now Pat. No. Des. 601,336.

(51) **LOC (9) Cl.** **02-04**

(52) **U.S. Cl.** **D2/980**

(58) **Field of Classification Search** D2/901,
D2/980-994, 601-612; 2/239-242, 409,
2/45, 59; 66/185-187, 172 R, 178 R, 201
See application file for complete search history.

(56) **References Cited**

U.S. PATENT DOCUMENTS

410,600	A *	9/1889	Mills	66/172 R
2,125,451	A *	8/1938	Kolliner	36/2 R
2,578,895	A *	12/1951	Meengs et al.	66/178 R
3,678,514	A *	7/1972	Safrit	2/212
D313,674	S *	1/1991	Sharpe	D29/120.1
5,509,282	A *	4/1996	Ferrell, Jr.	66/188
D442,765	S *	5/2001	Newman	D2/610

6,415,448	B1 *	7/2002	Glogover	2/239
6,978,643	B2 *	12/2005	Akers et al.	66/170
D554,849	S *	11/2007	Newson	D2/980
D601,336	S *	10/2009	Stewart	D2/980
D614,393	S *	4/2010	Stewart	D2/980
2008/0092275	A1 *	4/2008	Wei	2/242
2009/0072563	A1 *	3/2009	Phillips	294/149

* cited by examiner

Primary Examiner — Celia A. Murphy

Assistant Examiner — Kathleen M Sims

(74) *Attorney, Agent, or Firm* — Cowan, Liebowitz & Latman, P.C.

(57) **CLAIM**

The ornamental design for the assembly of sock components, as shown and described.

DESCRIPTION

FIG. 1 is a front, top and left side perspective view of a first embodiment of an assembly of sock components showing my new design;

FIG. 2 is a rear, bottom and right side perspective view thereof;

FIG. 3 is a left side view thereof;

FIG. 4 is a front, top and left side perspective view of a second embodiment of the assembly of sock components;

FIG. 5 is a rear, bottom and right side perspective view thereof; and,

FIG. 6 is a left side view thereof.

The broken lines in the Figures are for illustrative purposes only and form no part of the claimed design.

1 Claim, 2 Drawing Sheets

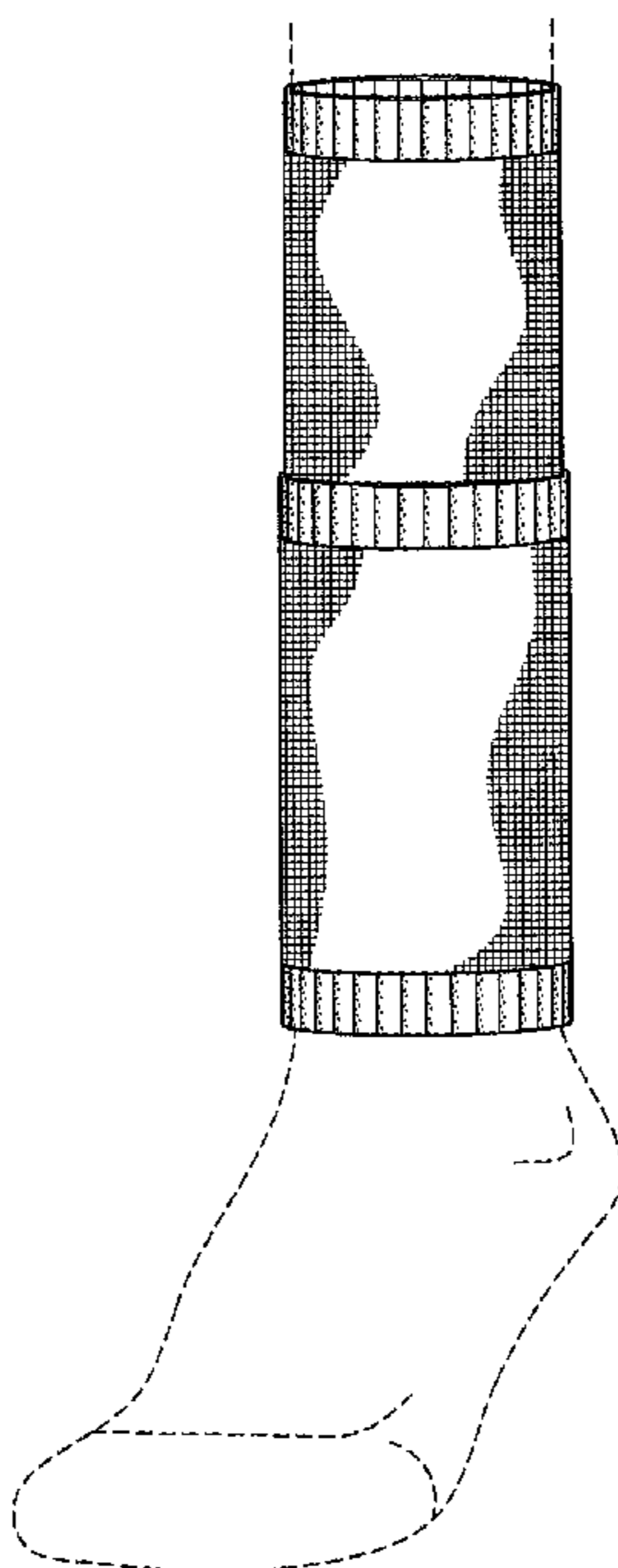

FIG. 1

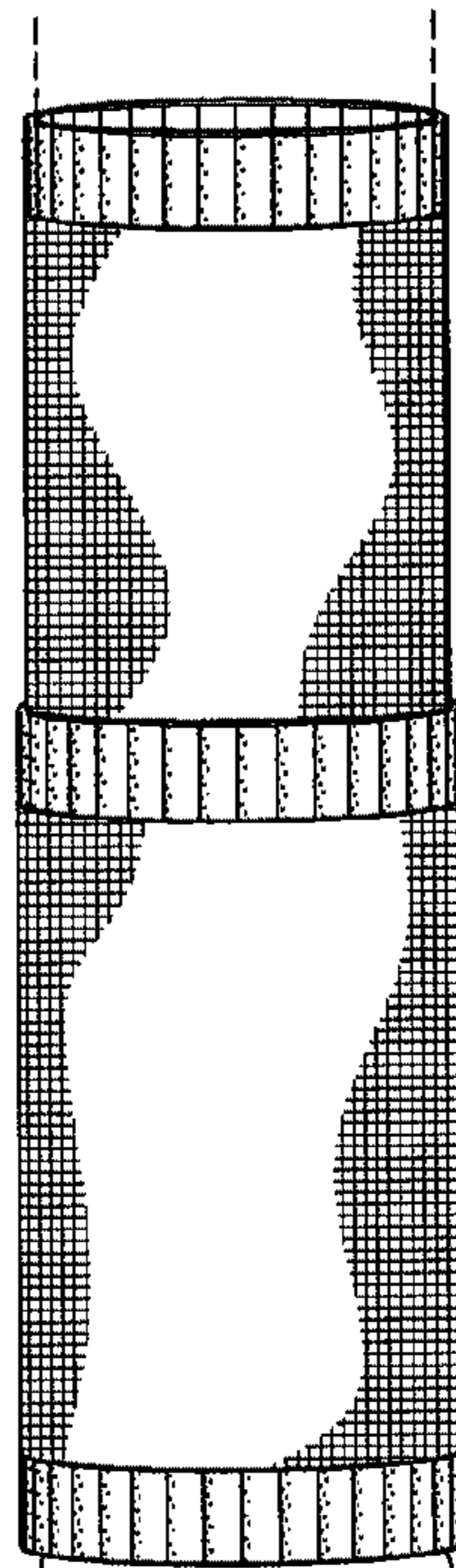

FIG. 2

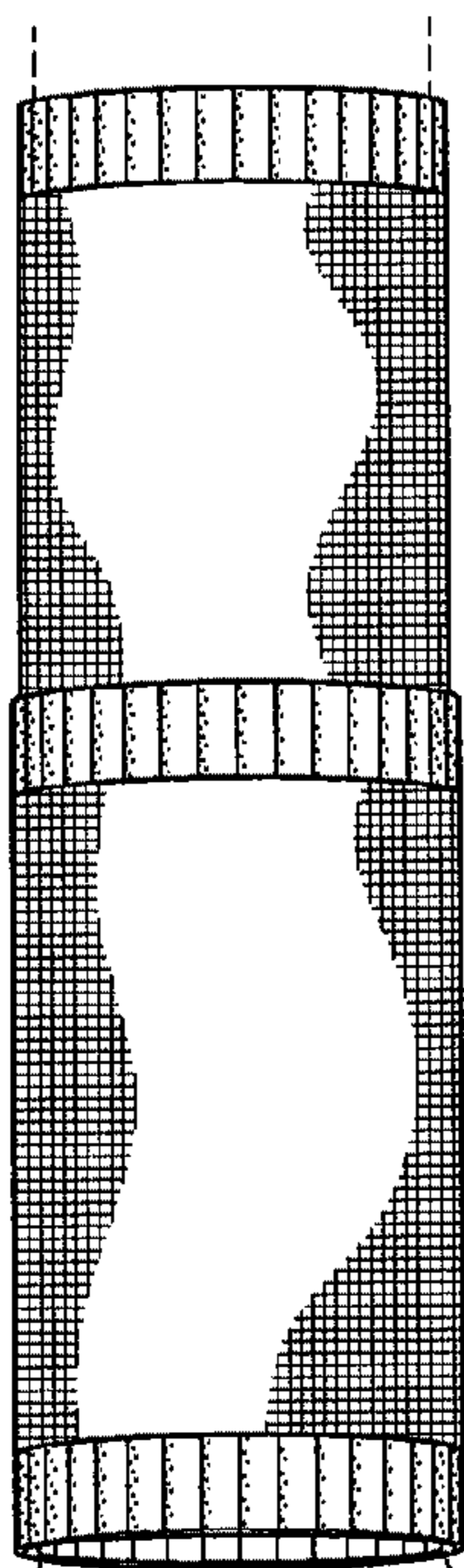

FIG. 3

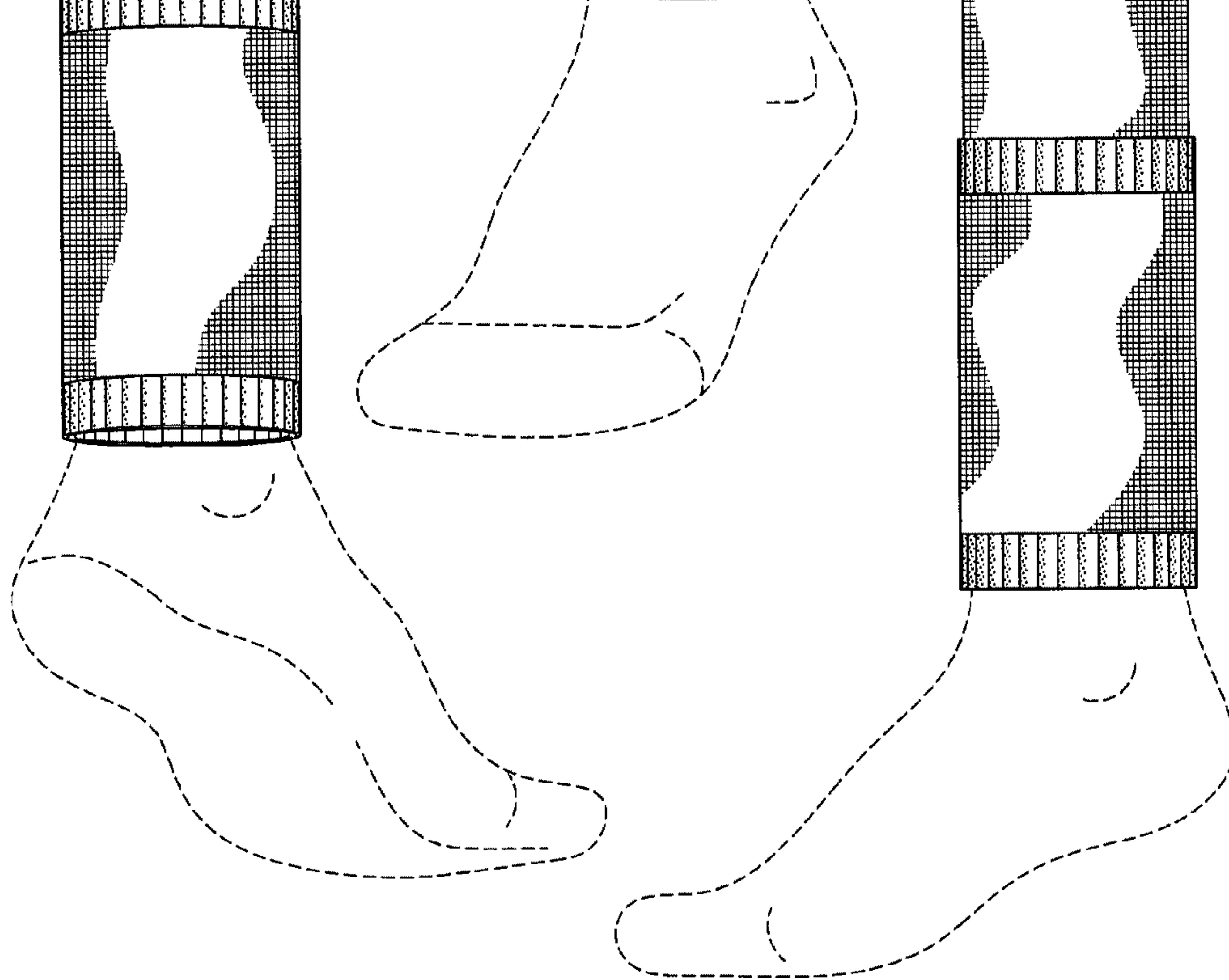
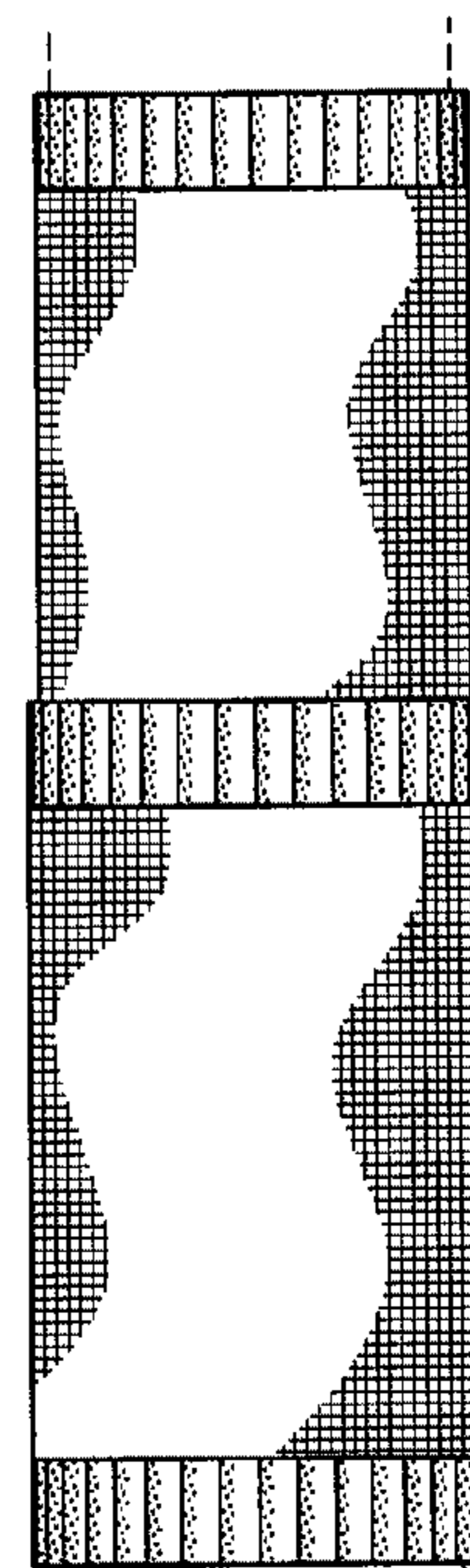

FIG. 4

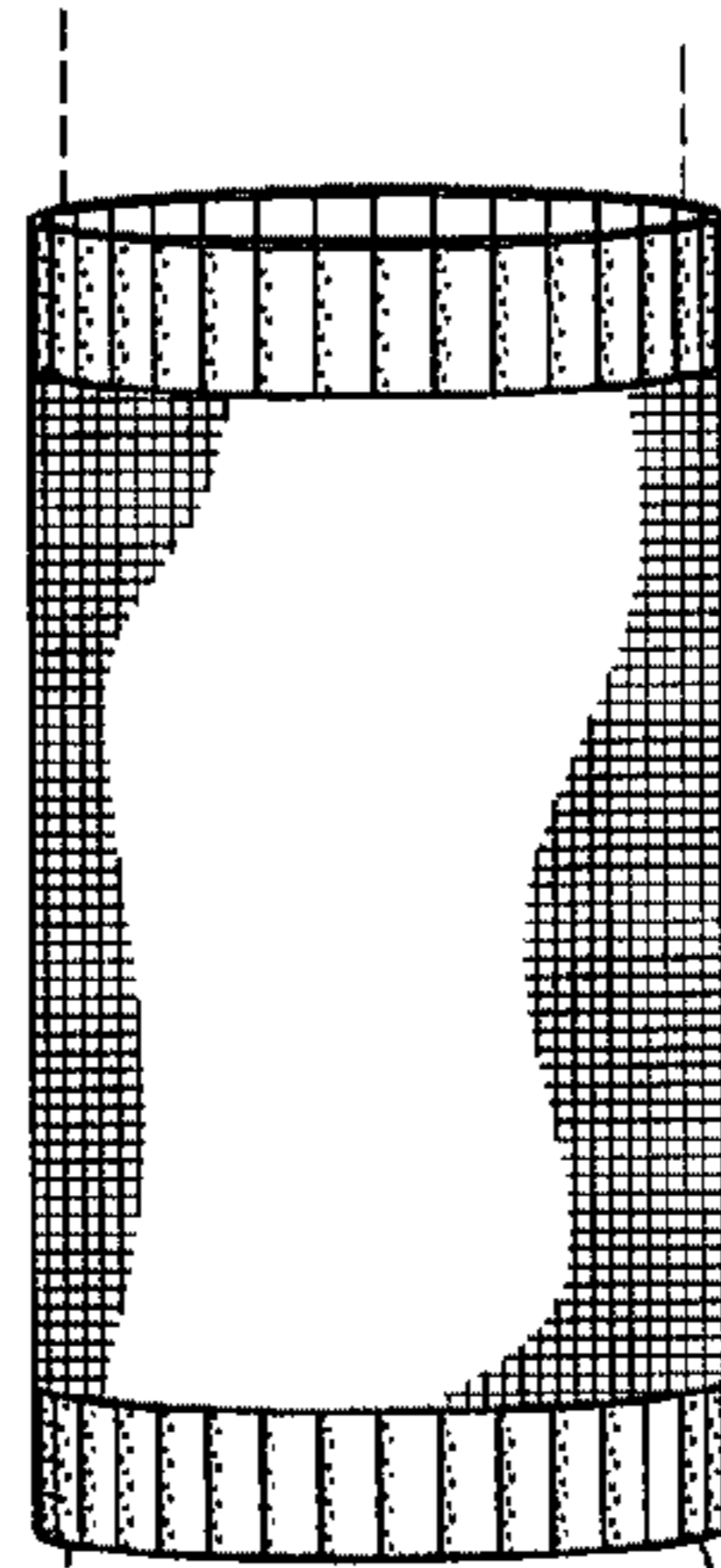

FIG. 5

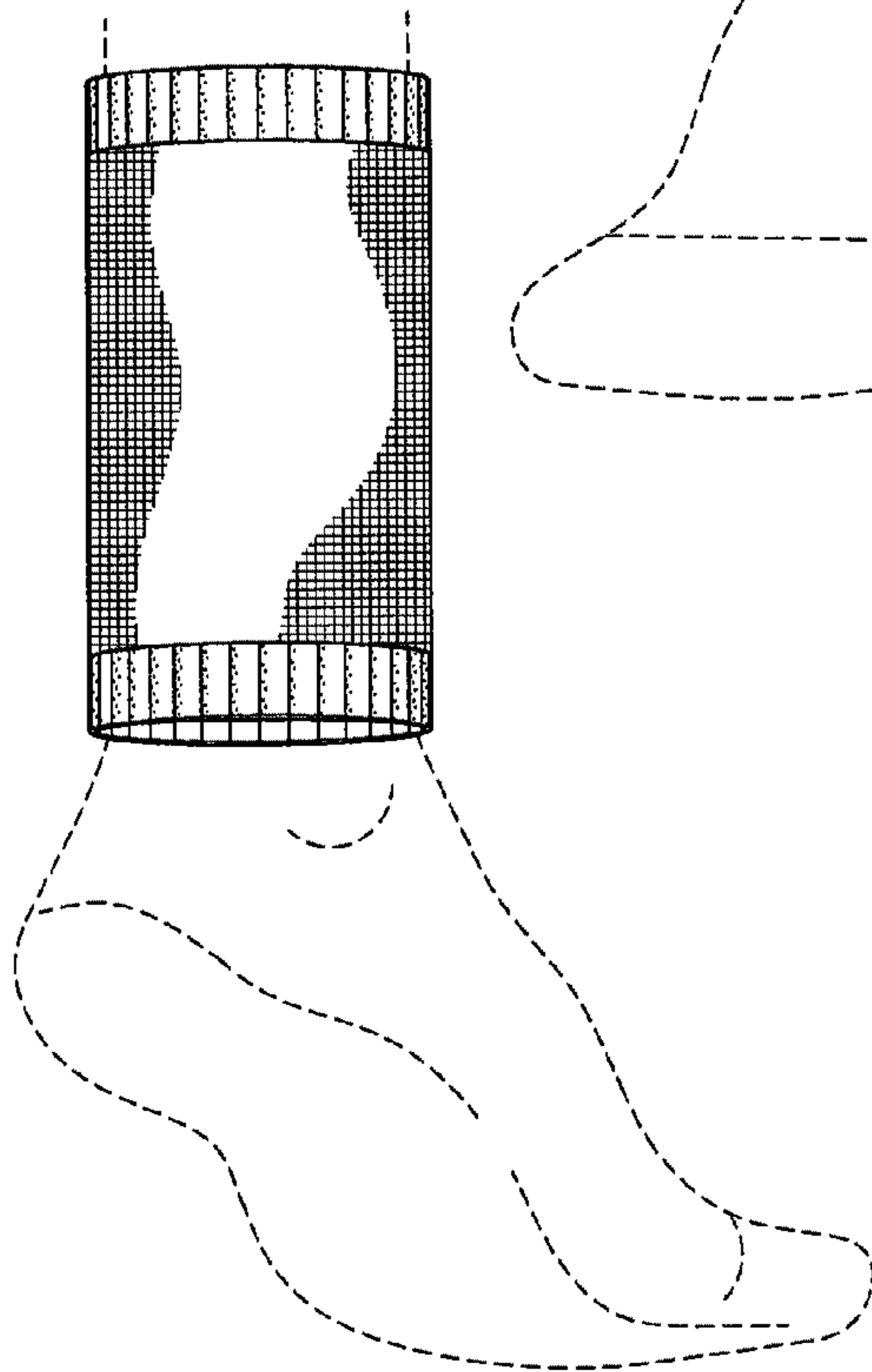

FIG. 6

