



US00D649730S

(12) **United States Design Patent**
Walter

(10) **Patent No.:** **US D649,730 S**
(45) **Date of Patent:** **** Nov. 29, 2011**

(54) **ROLLING BASKET**

(75) Inventor: **Ivor Michel Walter**, Boulder, CO (US)

(73) Assignee: **ASMA, Inc.**, Boulder, CO (US)

(**) Term: **14 Years**

(21) Appl. No.: **29/389,656**

(22) Filed: **Apr. 14, 2011**

(51) **LOC (9) Cl.** **12-02**

(52) **U.S. Cl.** **D34/14; D34/24; D34/19**

(58) **Field of Classification Search** D34/1-27;
280/47.26, 638, 641, 33.992, 651, 47.34,
280/79.2, 33.991, 33.995, 33.998

See application file for complete search history.

(56) **References Cited**

U.S. PATENT DOCUMENTS

D546,511	S *	7/2007	Luster	D32/37
D563,620	S	3/2008	Dong		
7,431,312	B2 *	10/2008	Sebastian et al.	280/33.998
7,494,163	B2 *	2/2009	Monts de Oca	292/143
7,594,667	B2	9/2009	Overland		
D608,073	S *	1/2010	Alves et al.	D34/24
D631,222	S	1/2011	Gimeno et al.		
D633,270	S	2/2011	Gimeno et al.		
D633,680	S	3/2011	Gimeno et al.		

D633,681	S	3/2011	Gimeno et al.		
D634,501	S *	3/2011	Overland	D34/19
2006/0103087	A1 *	5/2006	Alcala Sebastian	280/47.26

* cited by examiner

Primary Examiner — Cynthia Ramirez

(74) *Attorney, Agent, or Firm* — Margaret Polson; Oppedahl Patent Law Firm LLC

(57) **CLAIM**

The ornamental design for a rolling basket, as shown and described.

DESCRIPTION

FIG. 1 is a front perspective view of m new design for a rolling basket showing my new design;

FIG. 2 is a side elevation view of the right and left sides, which are minor images, of FIG. 1.

FIG. 3 is a front side elevation view of FIG. 1.

FIG. 4 is back side elevation view of FIG. 1.

FIG. 5 is a top plan view of FIG. 1; and,

FIG. 6 is a bottom plan view of FIG. 1.

The broken line showing of the wheels and handle is included for the purpose of illustrating environment and forms no part of the claimed design.

1 Claim, 5 Drawing Sheets

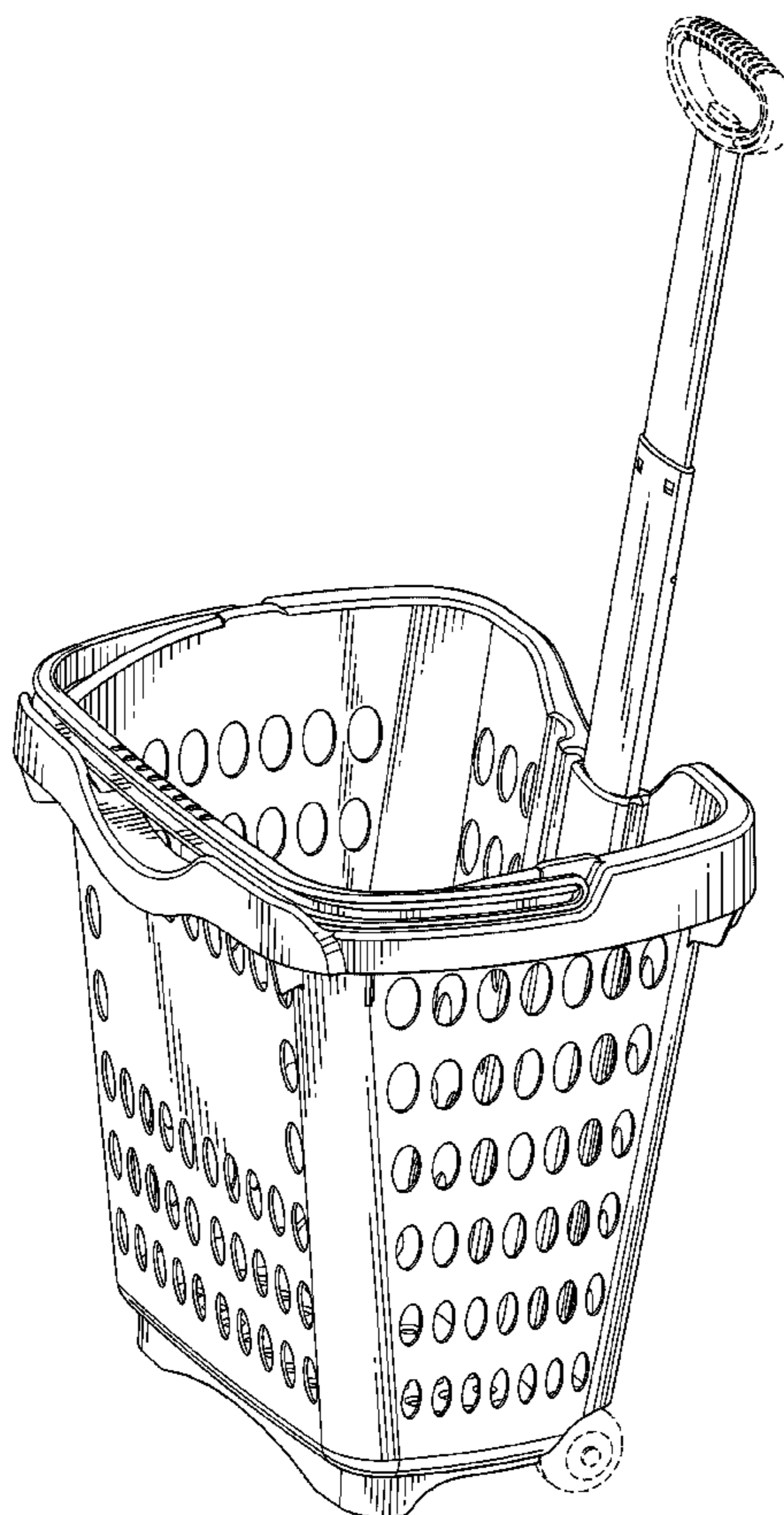

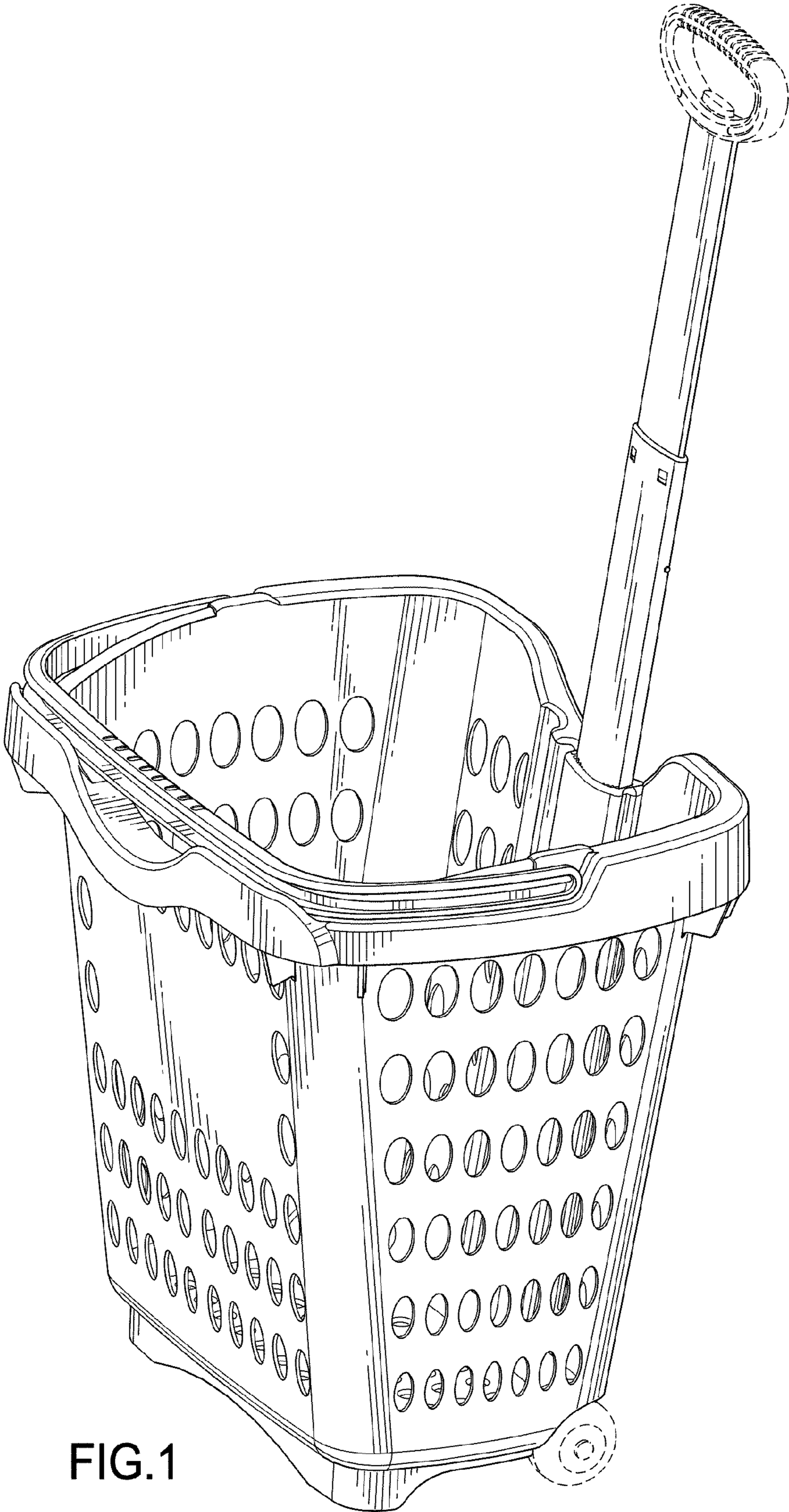

FIG.1

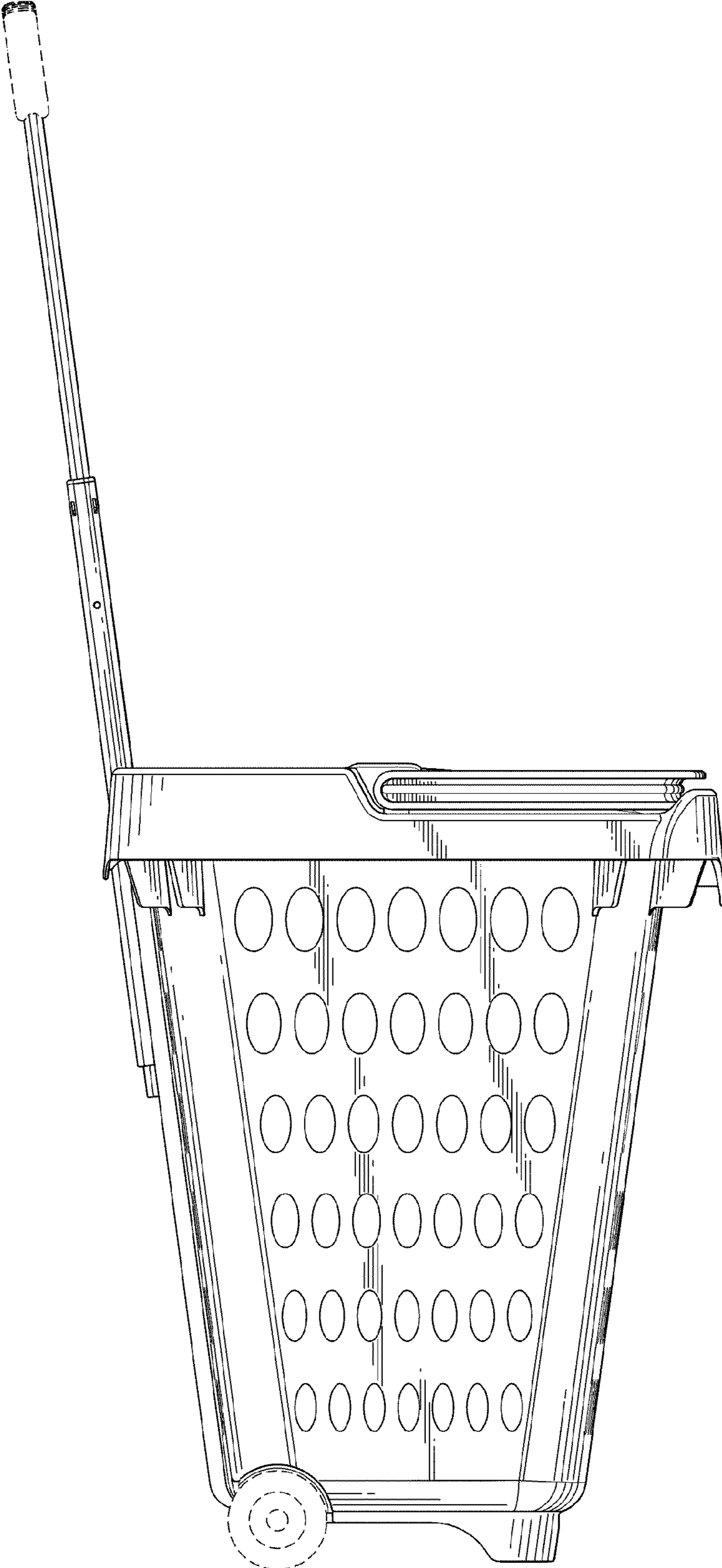

FIG. 2

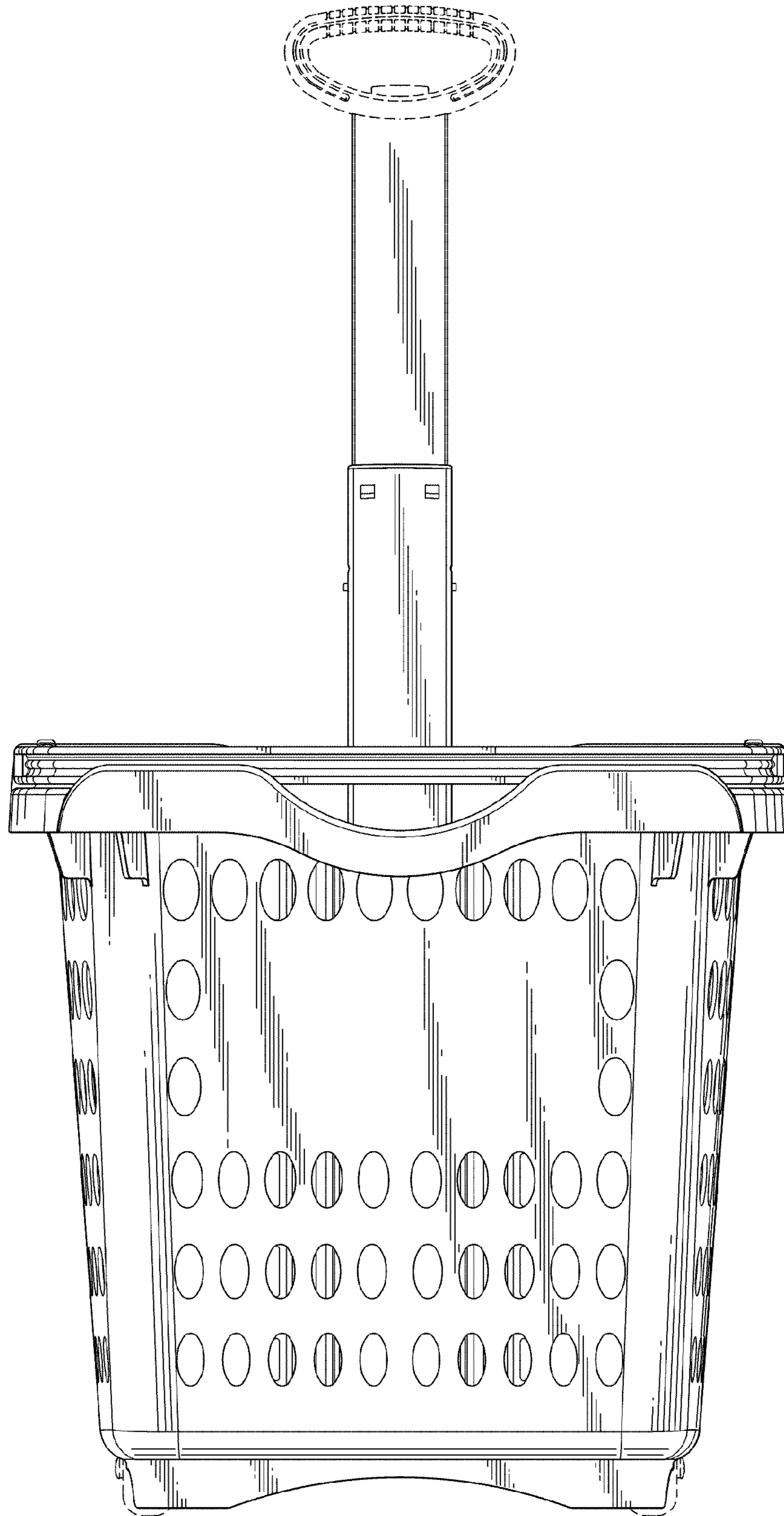

FIG.3

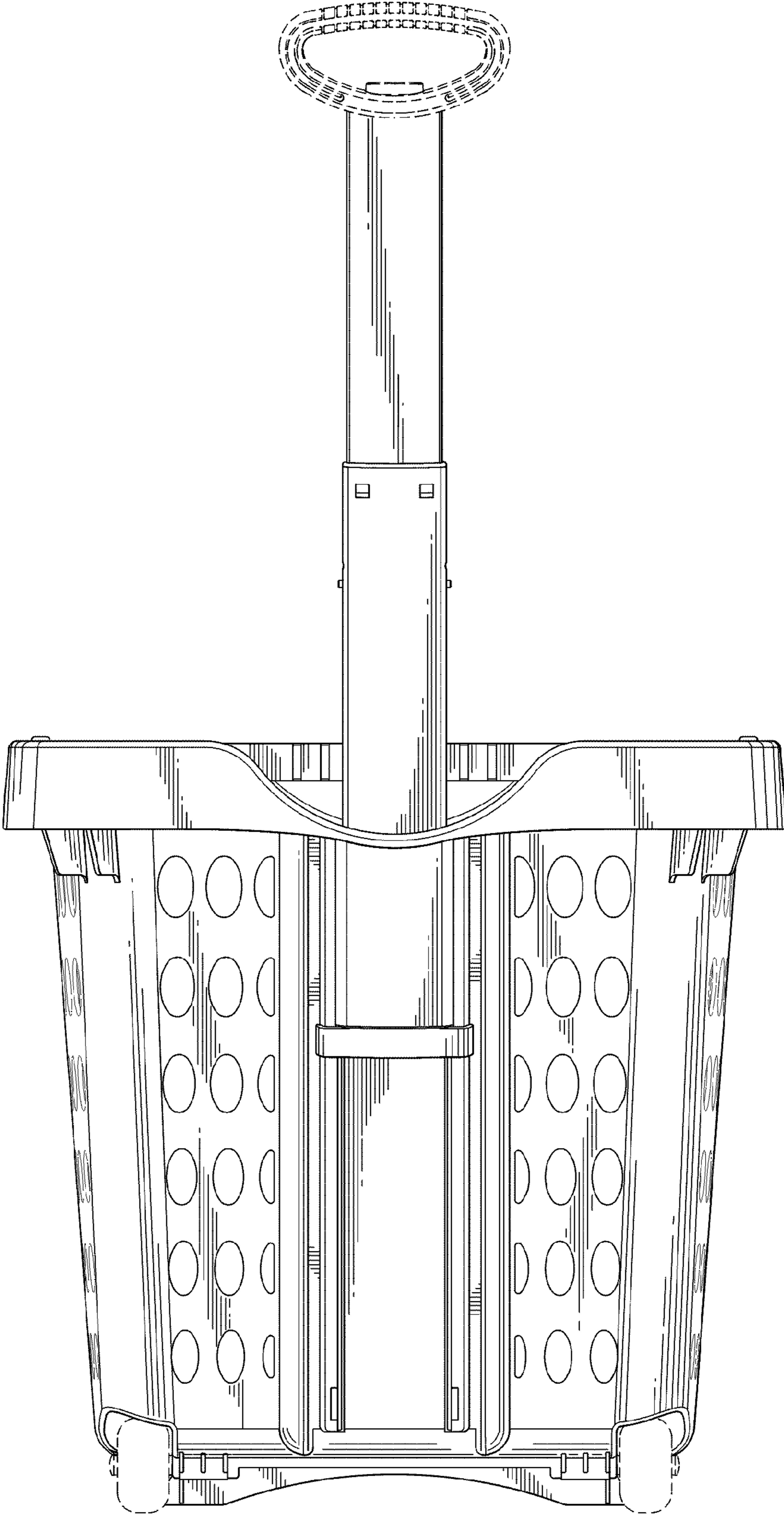

FIG.4

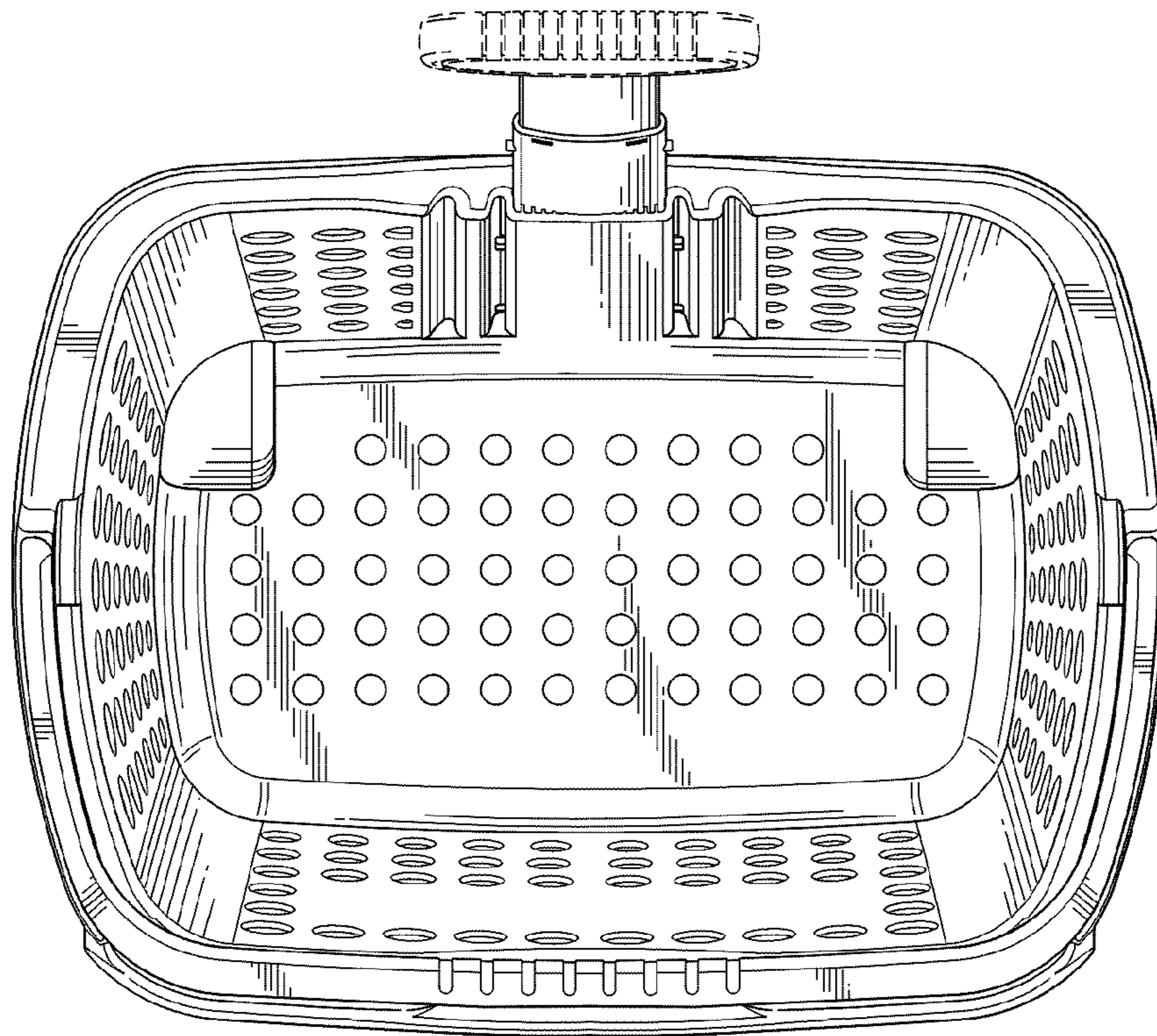

FIG. 5

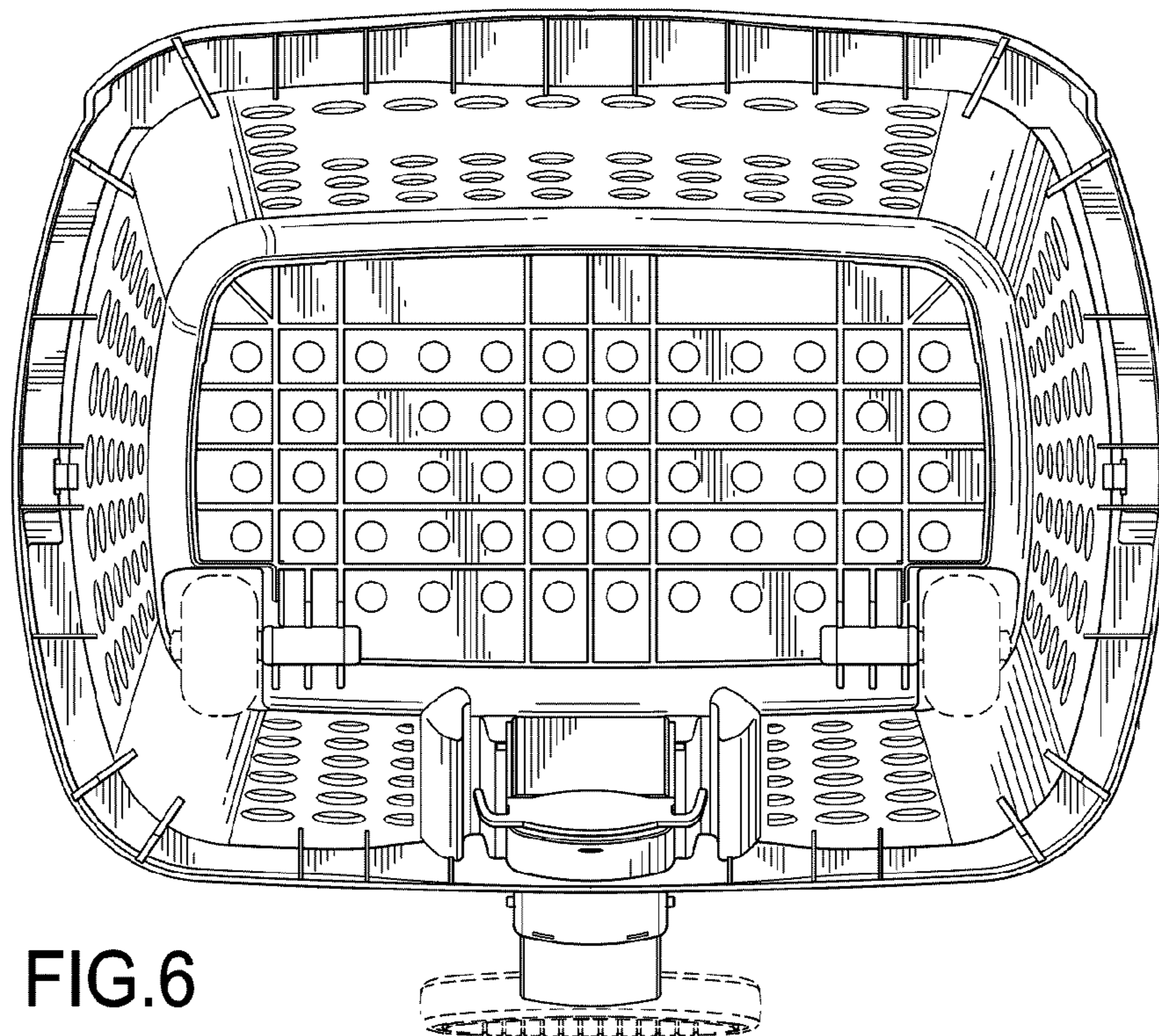

FIG. 6