



US00D649629S

(12) **United States Design Patent**
Ritzenhoff

(10) **Patent No.:** **US D649,629 S**

(45) **Date of Patent:** **** Nov. 29, 2011**

(54) **CONTAINER FOR STICK FRAGRANCE
DIFFUSERS**

(75) Inventor: **Andreas Ritzenhoff**, Marburg (DE)

(73) Assignee: **Seidel GmbH & Co. KG**, Marburg (DE)

(**) Term: **14 Years**

(21) Appl. No.: **29/365,696**

(22) Filed: **Jul. 13, 2010**

(30) **Foreign Application Priority Data**

Jan. 13, 2010 (DE) 00165617-4-0002

(51) **LOC (9) Cl.** **28-99**

(52) **U.S. Cl.** **D23/366**

(58) **Field of Classification Search** D23/355-369;
D28/5, 6; 261/DIG. 17, DIG. 42, DIG. 65,
261/DIG. 88, DIG. 89; 392/386, 390, 391,
392/392, 393, 394, 395; 239/34, 35, 44-47,
239/50, 53, 56, 60, 145, 326

See application file for complete search history.

(56) **References Cited**

U.S. PATENT DOCUMENTS

D434,481	S	11/2000	Bornstein et al.	
7,055,764	B1	6/2006	Martinez et al.	
D596,732	S *	7/2009	Butler et al.	D23/366
D605,746	S *	12/2009	Butler et al.	D23/366
D620,574	S *	7/2010	Jorgensen	D23/366
7,819,336	B2	10/2010	Newman	
2008/0217425	A1 *	9/2008	Butler et al.	239/45
2008/0308648	A1 *	12/2008	Pesu	239/44
2009/0039174	A1 *	2/2009	Gaines et al.	239/44
2009/0101729	A1 *	4/2009	Newman	239/44

OTHER PUBLICATIONS

Notice of Allowance issued in co-pending related U.S. Appl. No. 29/365,697 on Aug. 23, 2011.

* cited by examiner

Primary Examiner — Sandra Snapp

(74) *Attorney, Agent, or Firm* — Griffin & Spzipl, P.C.

(57) **CLAIM**

The ornamental design for a container for stick fragrance diffusers, as shown and described.

DESCRIPTION

The patent application filed contains at least one drawing. Any indicia shown in broken lines in the drawings form no part of the design to be patented. The container, which is shown to include two segments (i.e., an upper segment and a lower segment), is designed so that the upper segment is opaque and the lower segment is transparent so that, as part of the design, the stick fragrance diffusers are visible through the transparent lower segment.

FIG. 1 is a front view of the container for stick fragrance diffusers of the present invention.

FIG. 2 is a plan view of the container of the present invention.

FIG. 3 is a rear view of the container of the present invention.

FIG. 4 is a front perspective view of the container of the present invention.

FIG. 5 is a rear perspective view of the container of the present invention.

FIG. 6 is another front perspective view of the container of the present invention taken at a slightly different angle than in FIG. 4; and,

FIG. 7 is a bottom view of the container of the present invention.

The broken lines shown in the drawings are for illustrative purposes only and form no part of the claimed design.

1 Claim, 7 Drawing Sheets

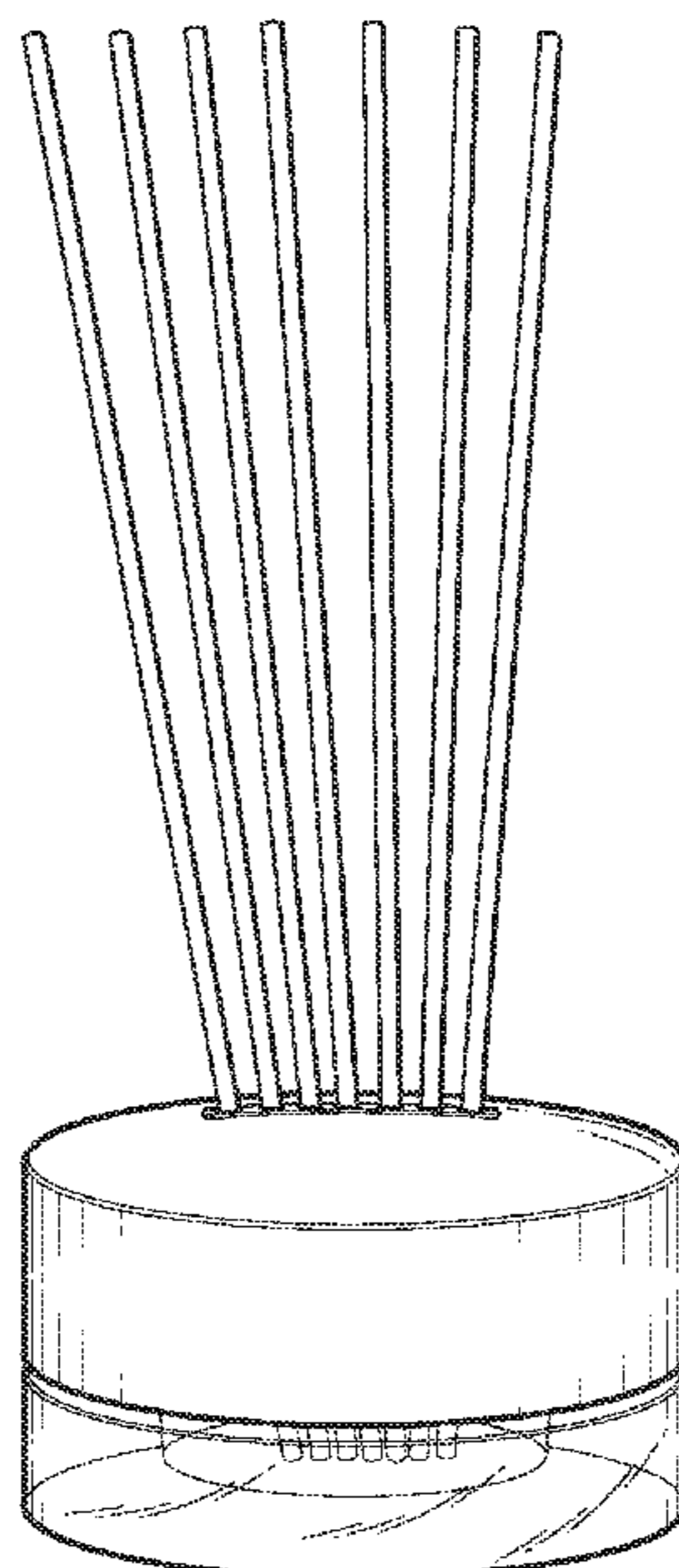

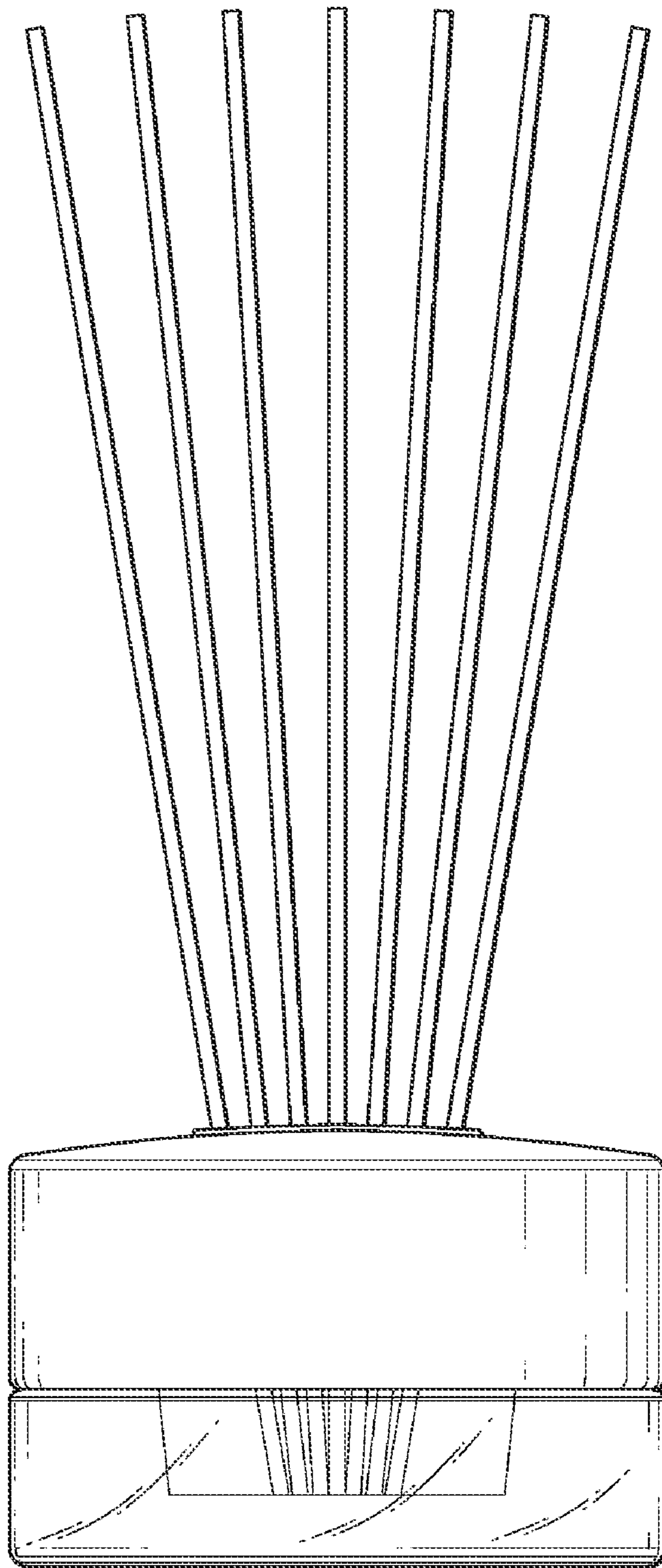

FIG. 1

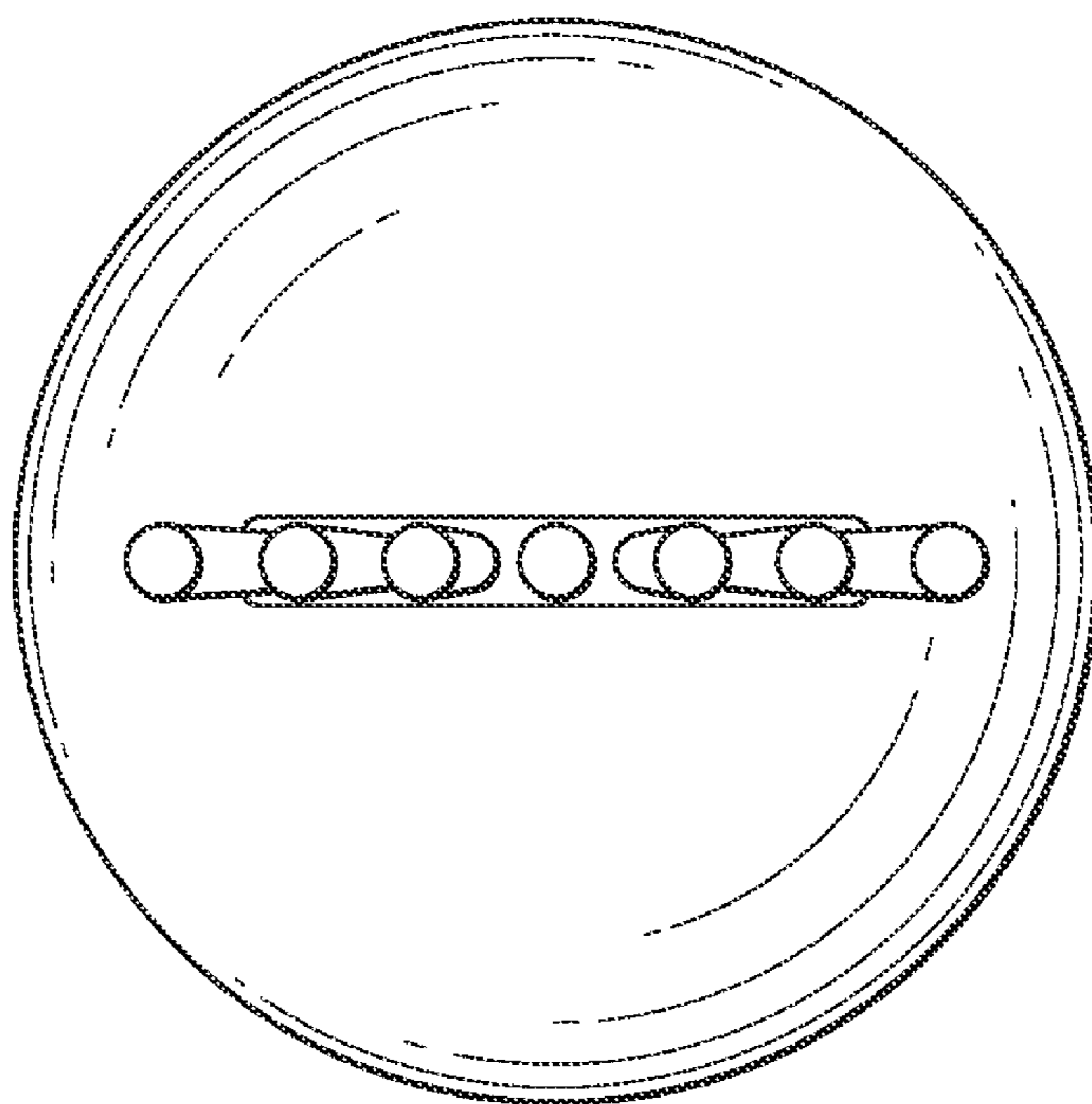

FIG. 2

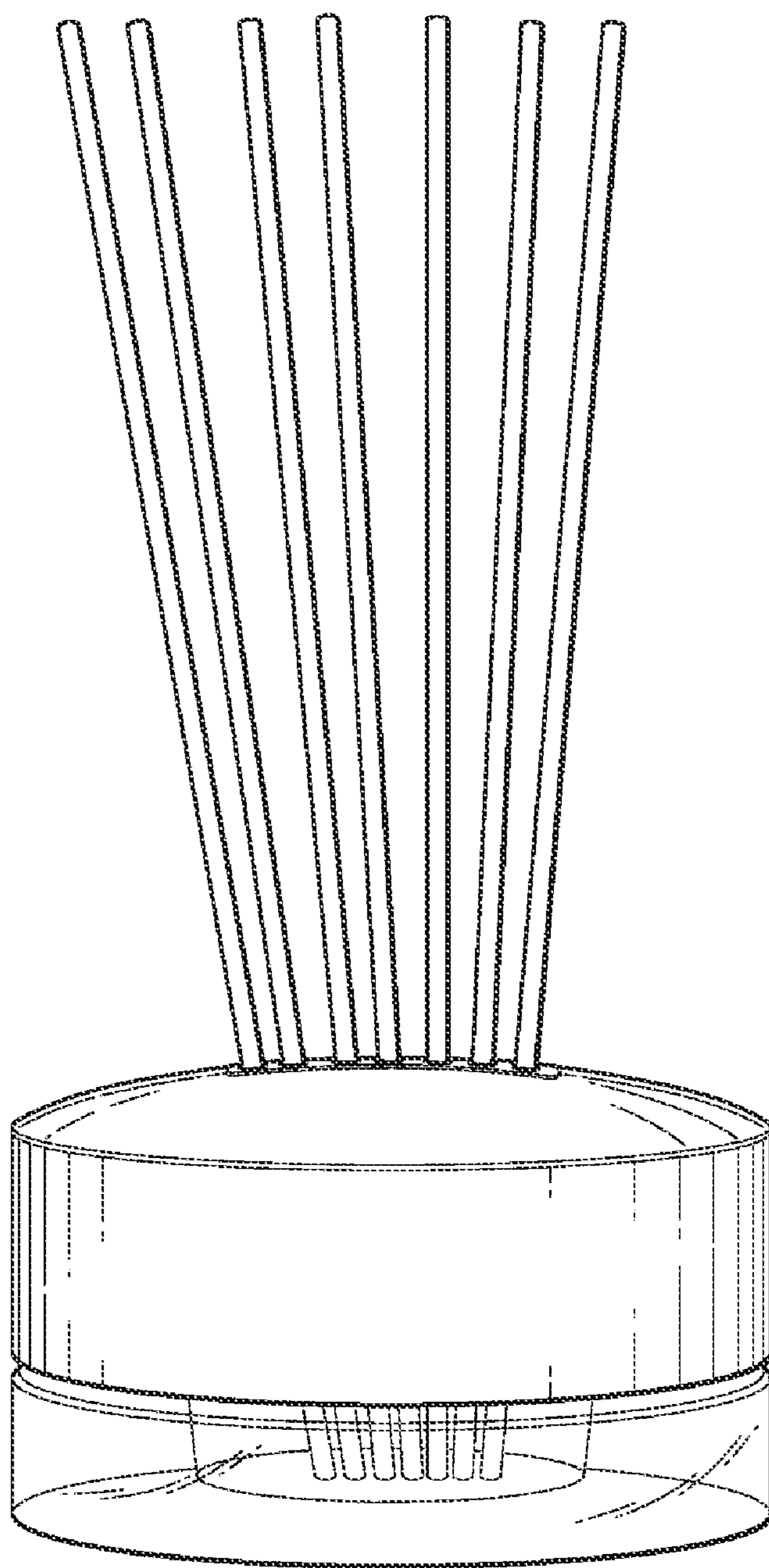

FIG. 3

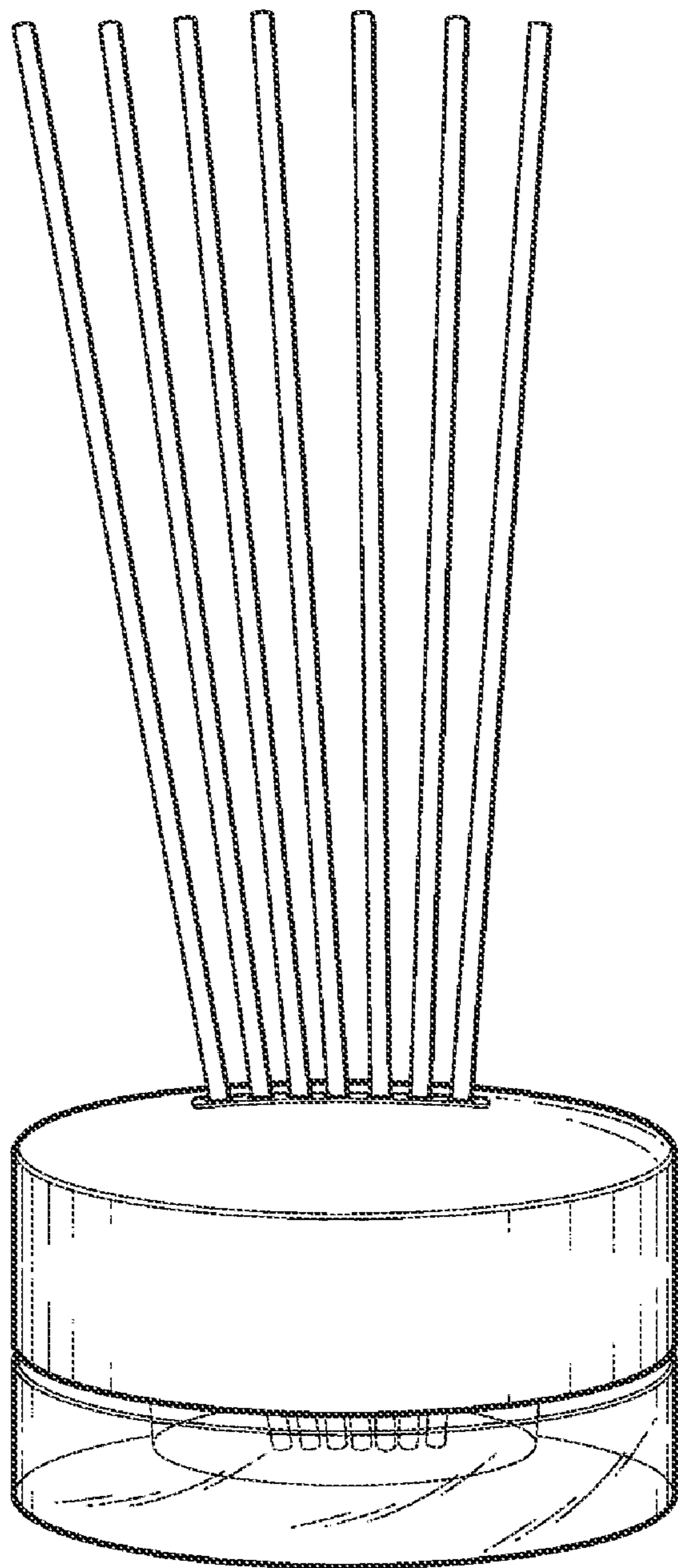

FIG. 4

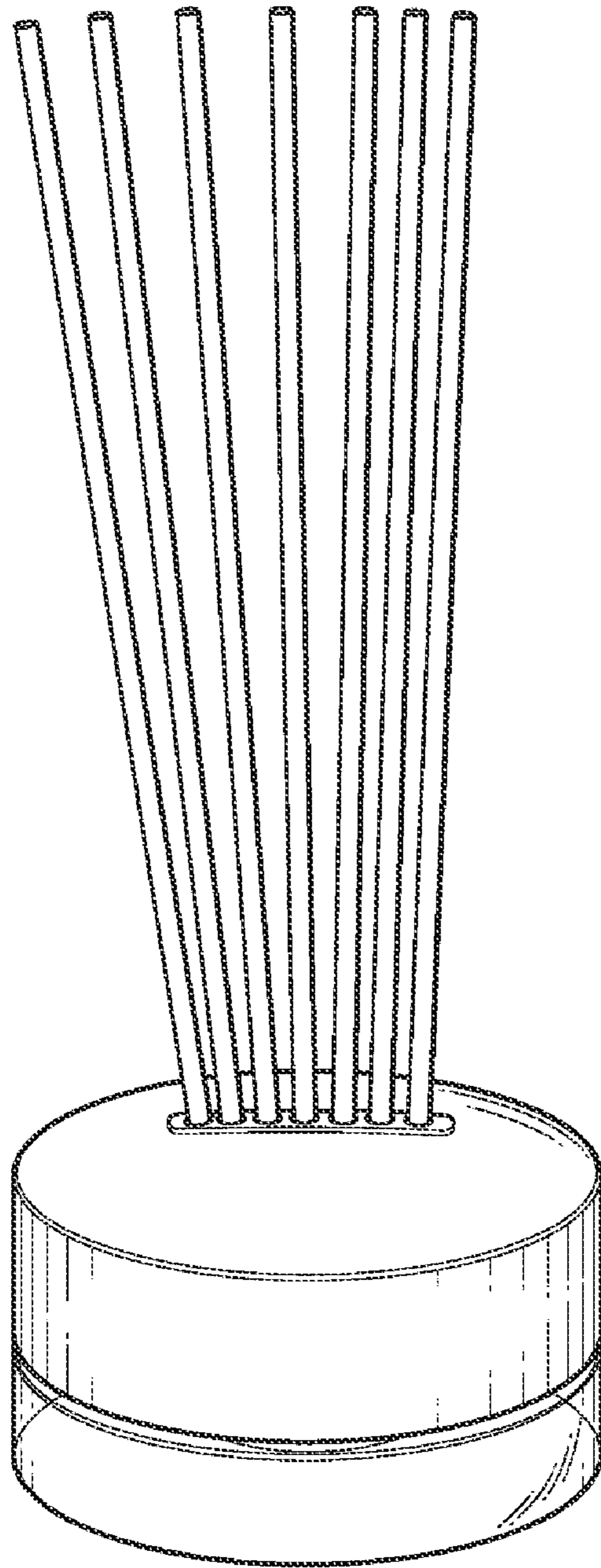

FIG. 5

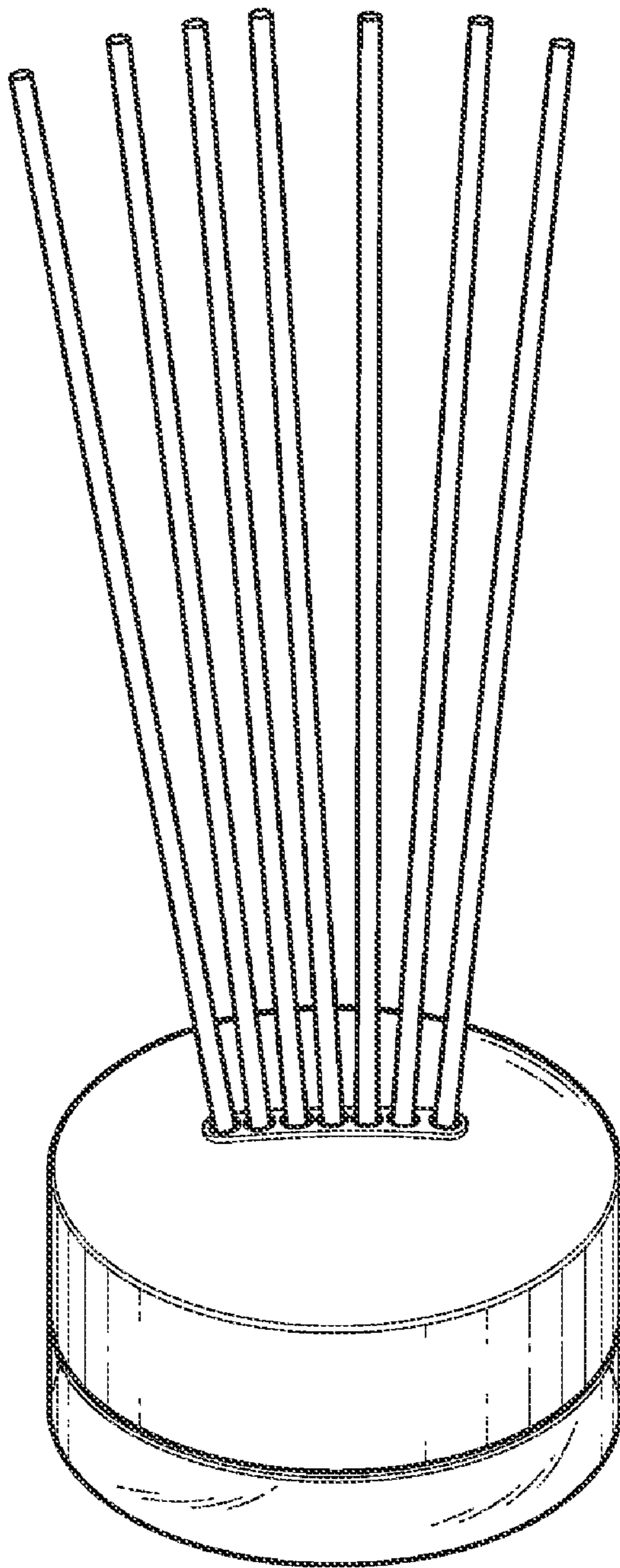

FIG. 6

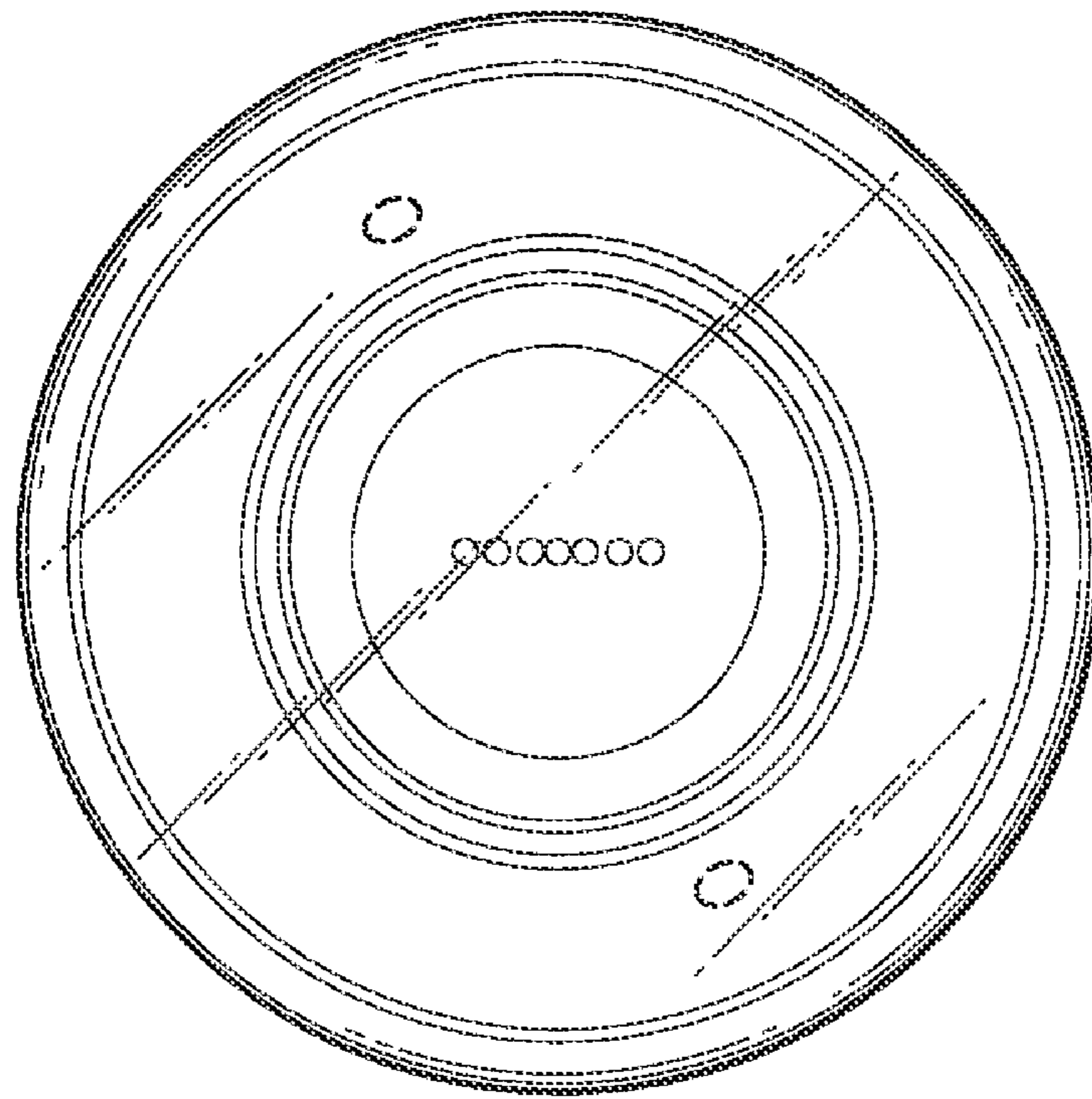

FIG. 7