



US00D649601S

(12) **United States Design Patent**
Buchanan

(10) **Patent No.:** **US D649,601 S**

(45) **Date of Patent:** **** Nov. 29, 2011**

(54) **TOSS GAME**

(75) Inventor: **Robert Buchanan**, Hamilton, OH (US)

(73) Assignee: **Robert Buchanan**, Hamilton, OH (US)

(**) Term: **14 Years**

(21) Appl. No.: **29/316,958**

(22) Filed: **Nov. 12, 2009**

(51) **LOC (9) Cl.** **21-01**

(52) **U.S. Cl.** **D21/303**

(58) **Field of Classification Search** D21/300-303,
D21/385, 386, 390; 273/348, 398-402, 407,
273/127 R; 473/569, 587, 588, 593, 594

See application file for complete search history.

(56) **References Cited**

U.S. PATENT DOCUMENTS

3,003,767	A *	10/1961	Keuls	273/138.1
3,400,932	A *	9/1968	Conrad	273/146
4,726,591	A *	2/1988	Johnson	273/339
4,927,160	A *	5/1990	Nichol et al.	273/371
D334,777	S *	4/1993	Caravella	D21/303
D359,991	S *	7/1995	Dean	D21/303
5,536,007	A *	7/1996	Snyder	273/118 R
6,244,598	B1 *	6/2001	Conville	273/402

D533,599	S *	12/2006	Bolter	D21/303
7,314,420	B2 *	1/2008	Konstant	473/594
D600,286	S *	9/2009	Pruitt	D21/303

* cited by examiner

Primary Examiner — Prabhakar Deshmukh

(57) **CLAIM**

The ornamental design for a toss game, as shown and described.

DESCRIPTION

FIG. 1 is an exploded bottom perspective view of a toss game showing my design;

FIG. 2 is a top perspective view thereof;

FIG. 3 is a front elevational view thereof;

FIG. 4 is an enlarged front elevational of a red bean bag, also shown in FIG. 1.

FIG. 5 is a side elevational view of FIG. 4;

FIG. 6 is an enlarged front elevational view of a green bean bag, also shown in FIG. 1; and,

FIG. 7 is a side elevational view of FIG. 6.

The surfaces in the drawing are lined for specific colors.

The broken lines showing of electrical connector and cable are for illustrative purpose only and form no part of the claimed design.

1 Claim, 4 Drawing Sheets

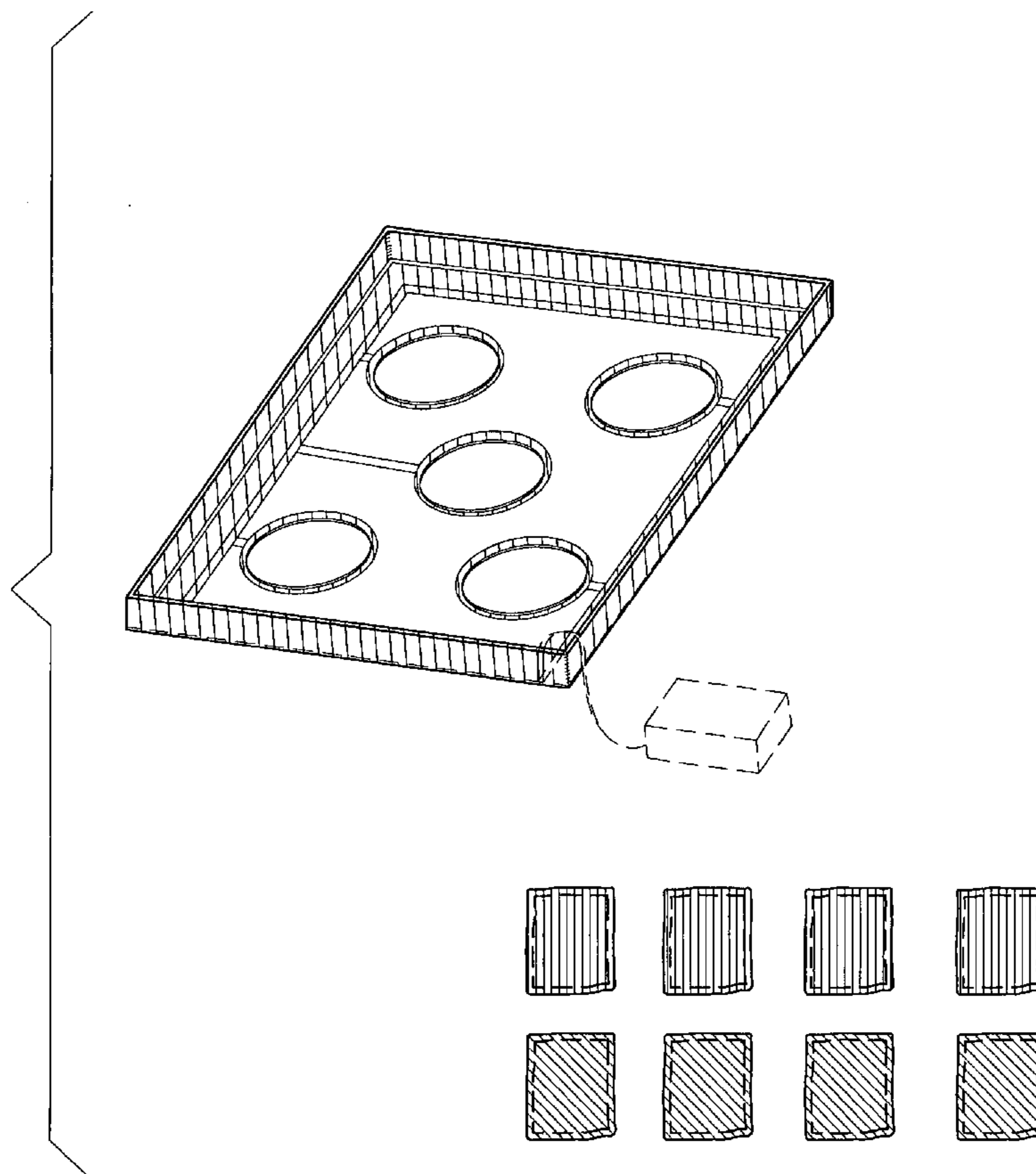

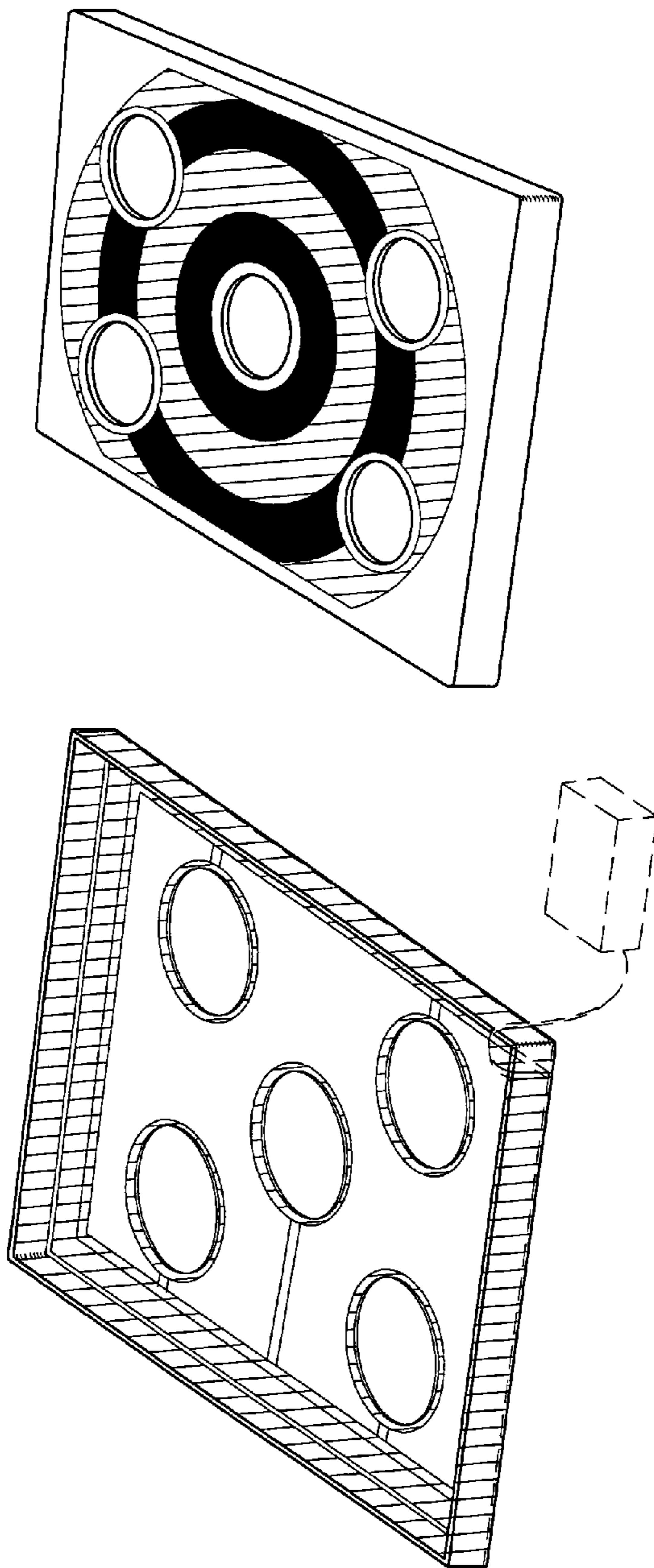
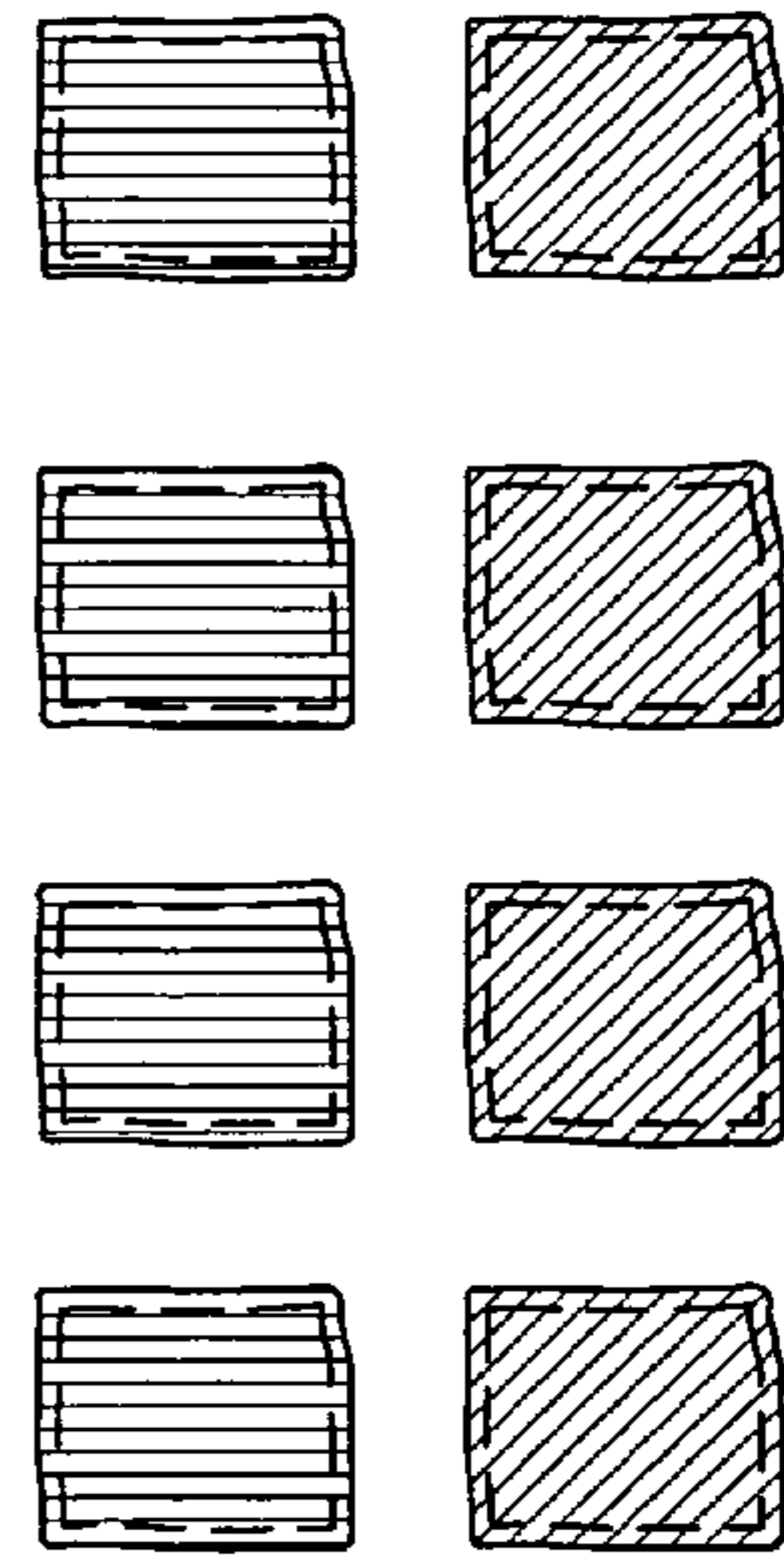

FIG. 2

FIG. 1



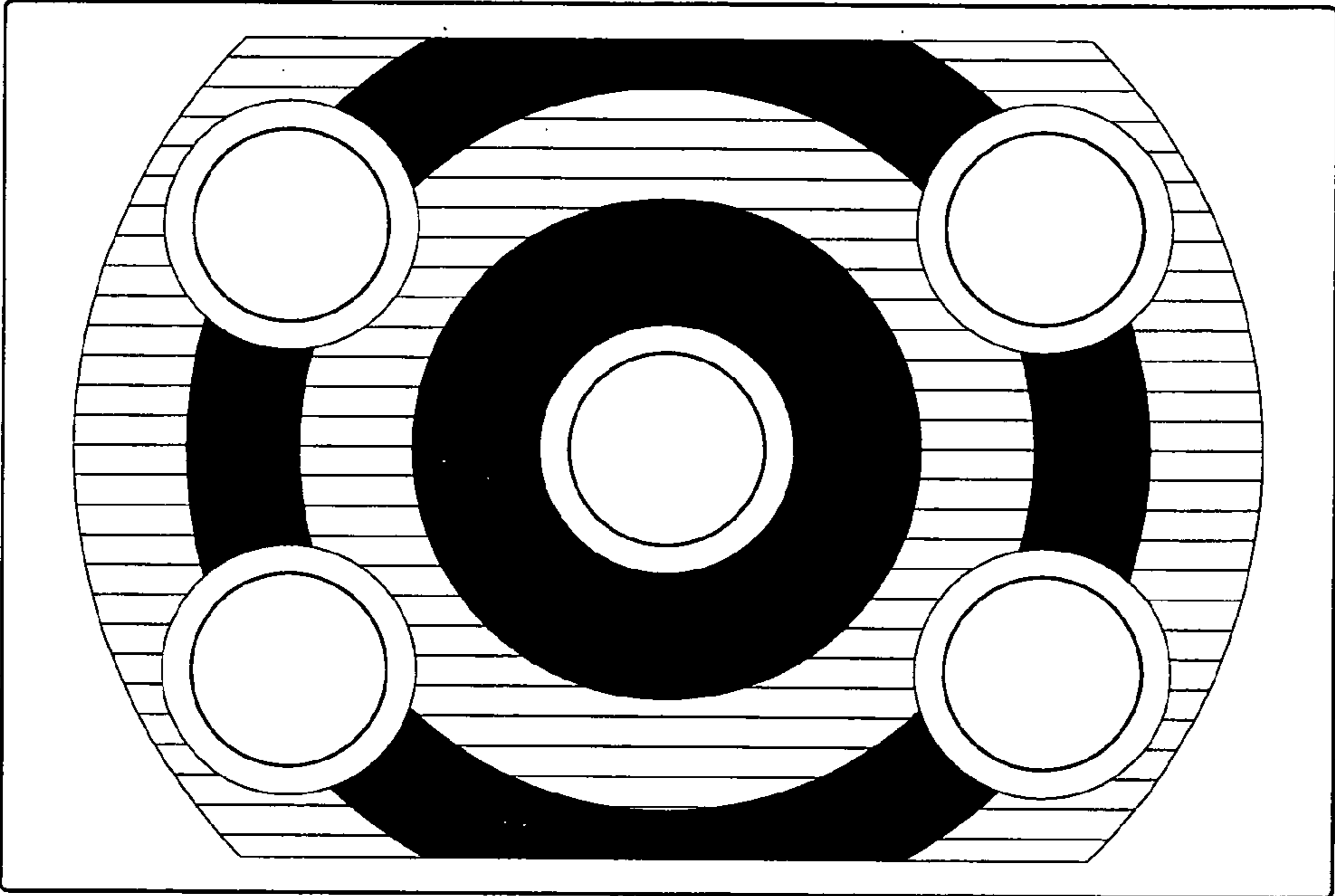

FIG. 3



FIG. 5

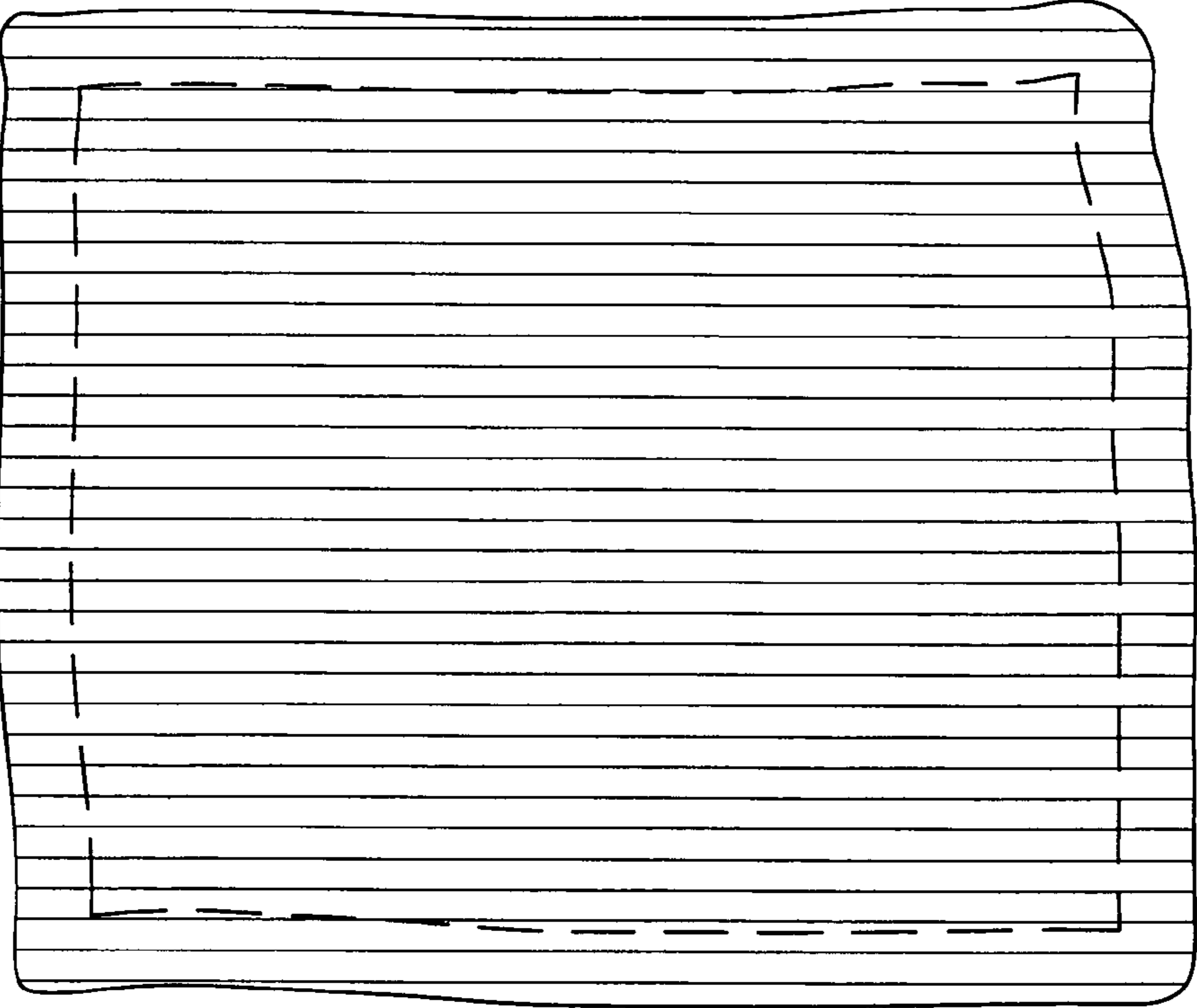

FIG. 4

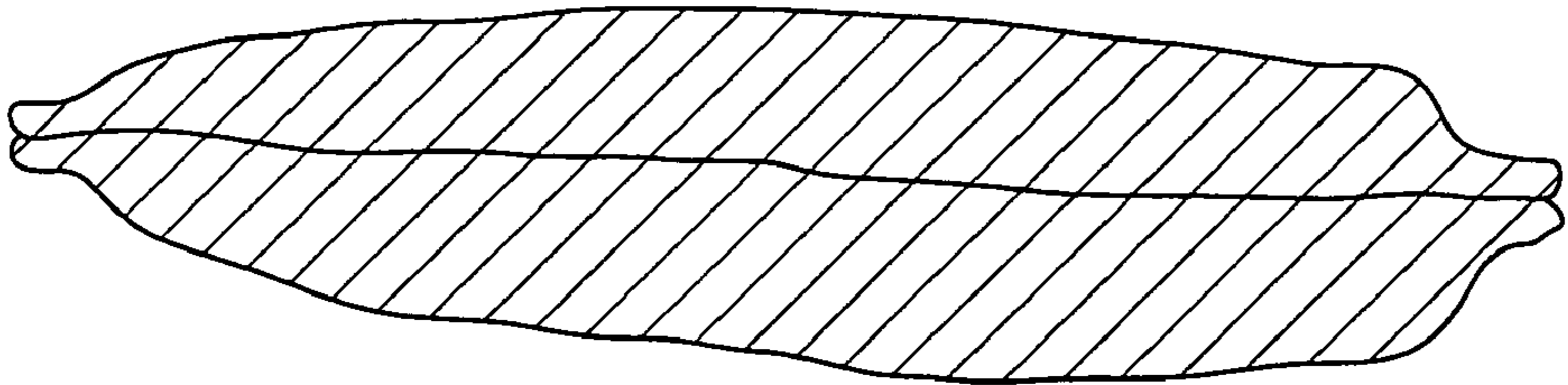

FIG. 7

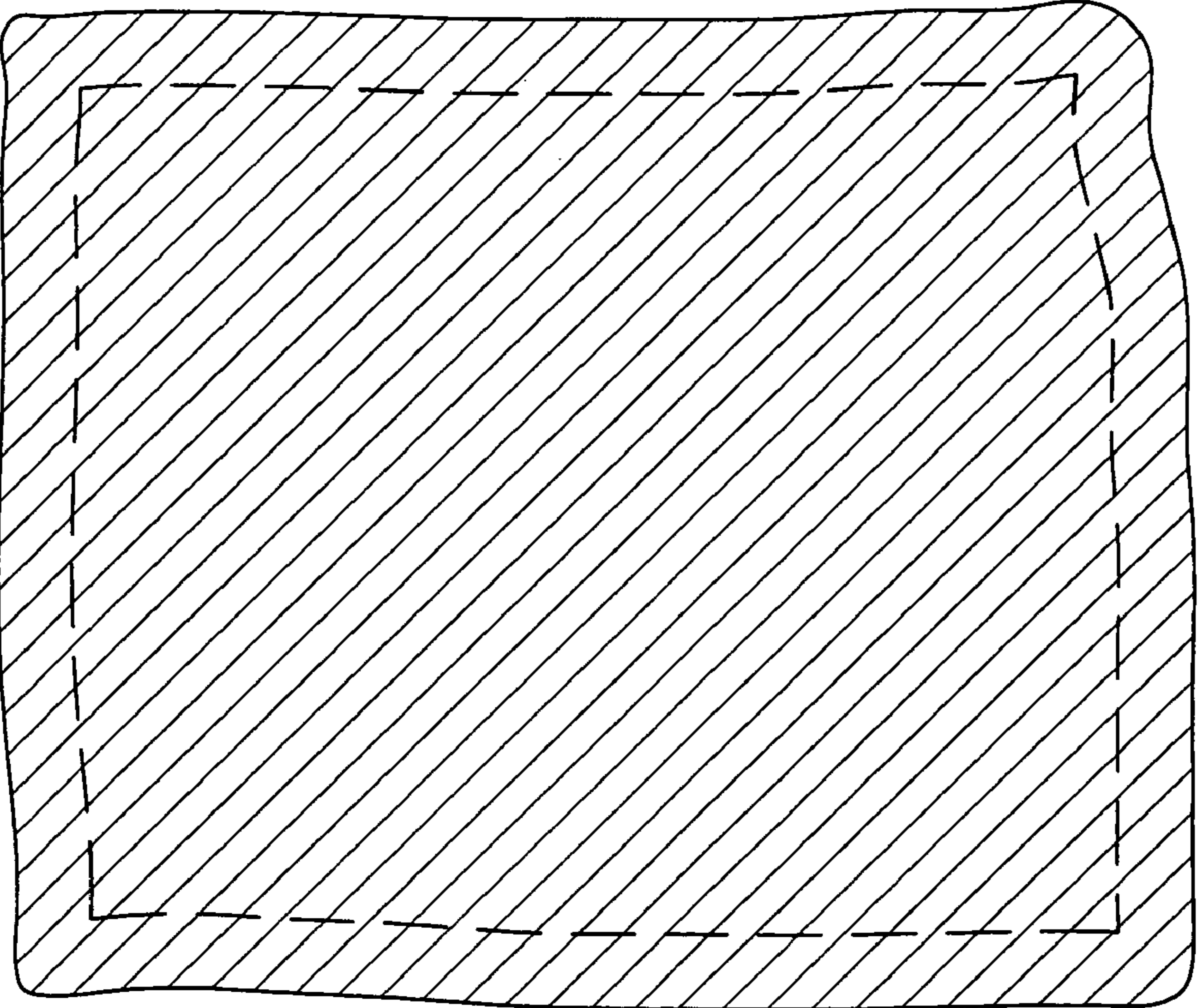

FIG. 6