



US00D649524S

(12) **United States Design Patent**
Miyazaki

(10) **Patent No.:** **US D649,524 S**

(45) **Date of Patent:** **** Nov. 29, 2011**

(54) **PORTABLE RECORDER**

(75) Inventor: **Tetsuro Miyazaki**, Tokyo (JP)

(73) Assignee: **Sony Corporation**, Tokyo (JP)

(**) Term: **14 Years**

(21) Appl. No.: **29/371,439**

(22) Filed: **Feb. 28, 2011**

(30) **Foreign Application Priority Data**

Aug. 27, 2010 (CN) 2010 3 0508563
Sep. 2, 2010 (JP) D2010-021282
Dec. 24, 2010 (CN) 2010 3 0703517
Dec. 24, 2010 (CN) 2010 3 0703518
Dec. 24, 2010 (JP) D2010-030759

(51) **LOC (9) Cl.** **14-01**

(52) **U.S. Cl.** **D14/167**

(58) **Field of Classification Search** D14/167,
D14/154, 168, 188, 496, 156, 160, 161, 162,
D14/163, 164, 165, 158, 203.1, 341, 346,
D14/342, 345, 225, 226, 228, 227, 214, 247,
D14/203.7; 455/351, 350; D19/60, 62; D21/330;
369/44.14, 44.32; 700/94

See application file for complete search history.

(56) **References Cited**

U.S. PATENT DOCUMENTS

D418,513 S * 1/2000 Suzuki et al. D14/228
D474,490 S * 5/2003 Ogasawara D16/208
D486,466 S * 2/2004 Tanaka D14/167
D489,057 S * 4/2004 Obata et al. D14/225
D542,262 S 5/2007 Oka
D554,628 S * 11/2007 Aoki D14/226
D567,798 S 4/2008 Oka

D571,778 S * 6/2008 Aoki D14/167
D578,994 S * 10/2008 Oka D14/167
D581,898 S * 12/2008 Oka D14/167
D601,120 S * 9/2009 Aoki D14/167
D604,720 S * 11/2009 Liu D14/216
D611,925 S * 3/2010 Miyazaki D14/167
D623,166 S * 9/2010 Oka D14/167
D623,172 S * 9/2010 Kondo et al. D14/227

FOREIGN PATENT DOCUMENTS

JP D1307512 S 8/2007
JP D1318721 S 1/2008
JP D1328924 S 5/2008
JP D1340062 S 9/2008
JP D1375553 S 12/2009
JP D1375599 S 12/2009
JP D1390071 S 6/2010

* cited by examiner

Primary Examiner — Austin Murphy

(74) *Attorney, Agent, or Firm* — Rader, Fishman & Grauer PLLC

(57) **CLAIM**

The ornamental design for a portable recorder, as shown and described.

DESCRIPTION

FIG. 1 is a perspective view of a portable recorder showing our new design;

FIG. 2 is a front elevational view thereof;

FIG. 3 is a rear elevational view thereof;

FIG. 4 is a left side elevational view thereof;

FIG. 5 is a right side elevational view thereof;

FIG. 6 is a top plan view thereof; and,

FIG. 7 is a bottom plan view thereof.

Portions in broken lines are for illustrative purposes only and form no part of claimed design. Dot-dash broken lines define the boundaries of, but not included in, the claimed design.

1 Claim, 5 Drawing Sheets

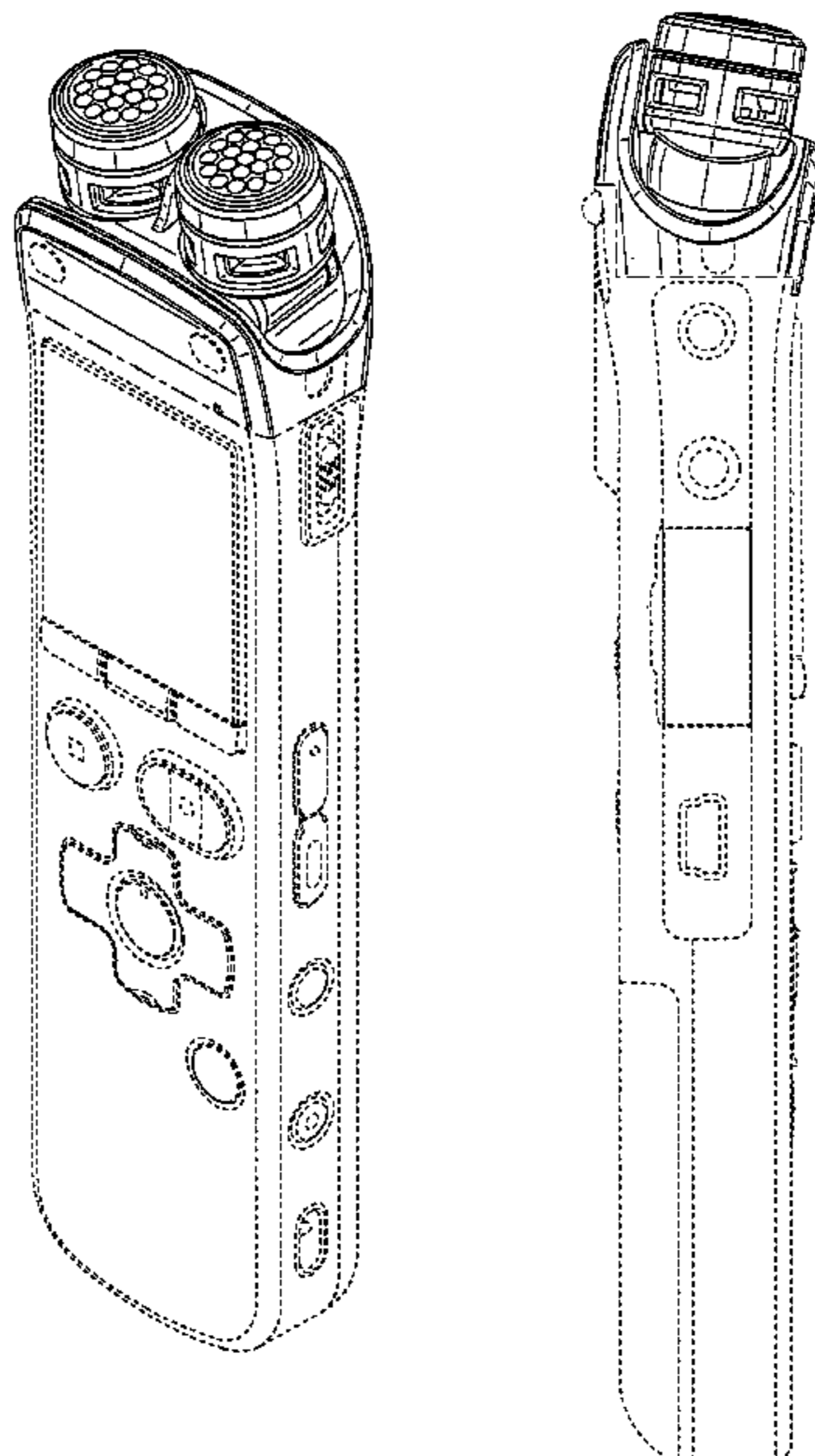

FIG. 1

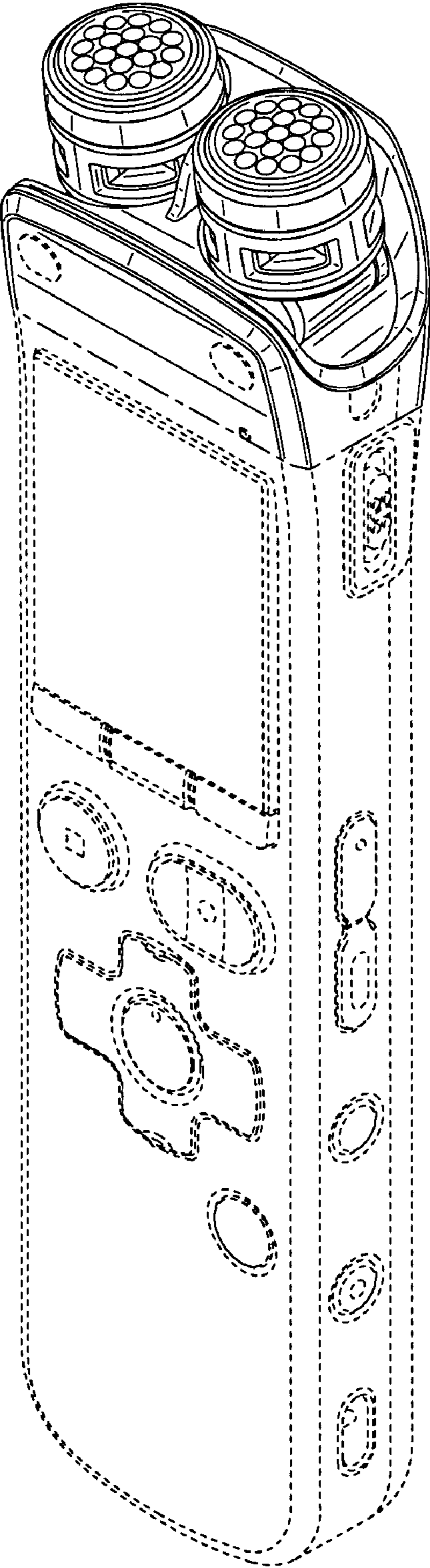

FIG.2

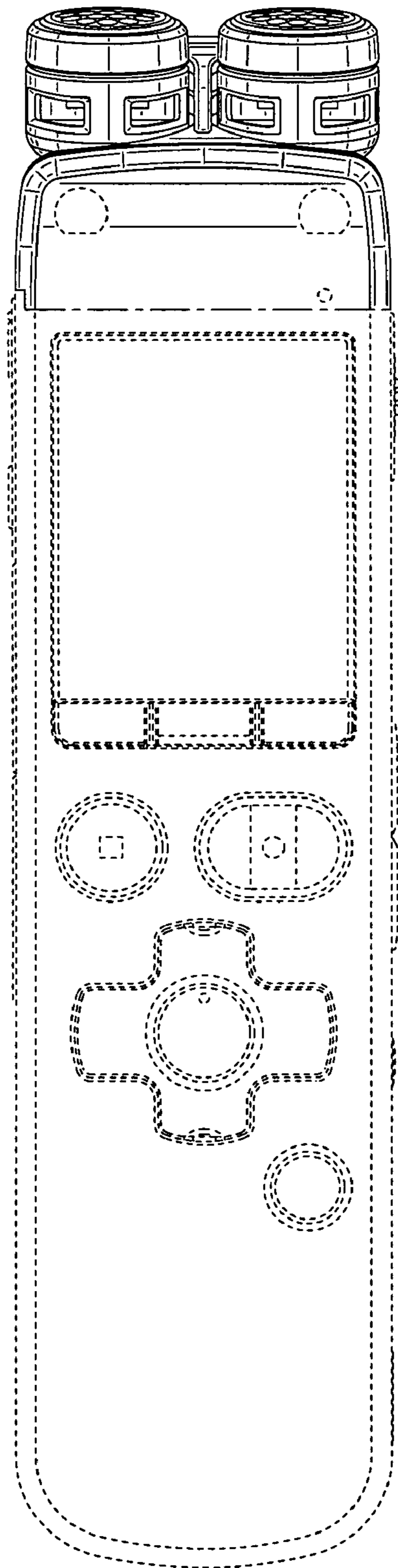

FIG. 3

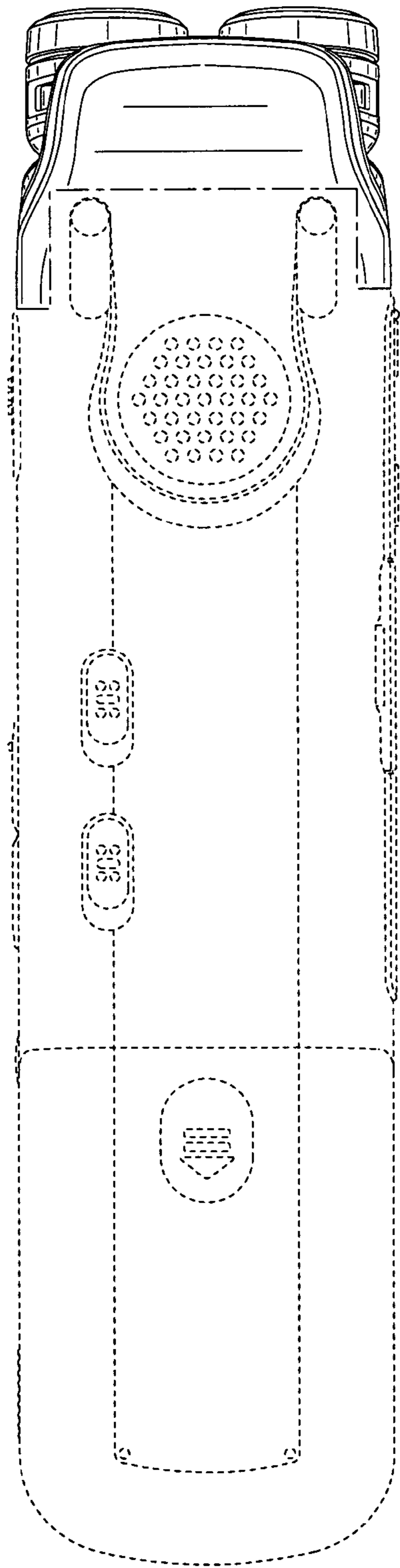

FIG.4

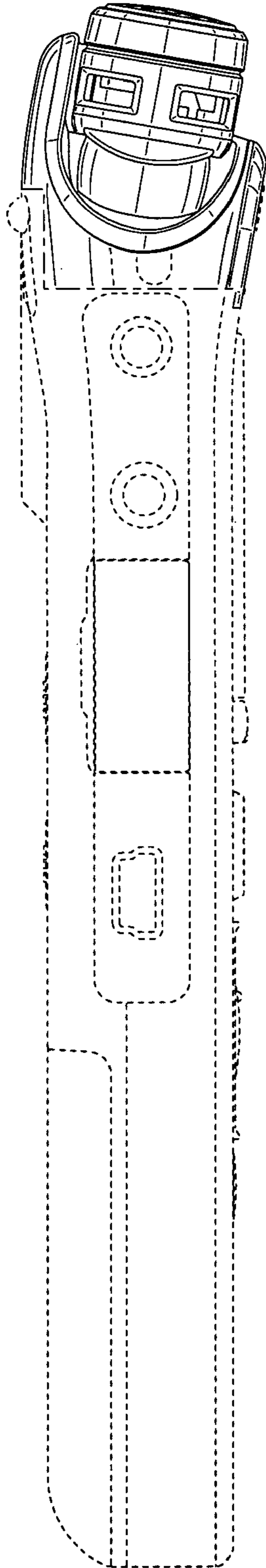

FIG.5

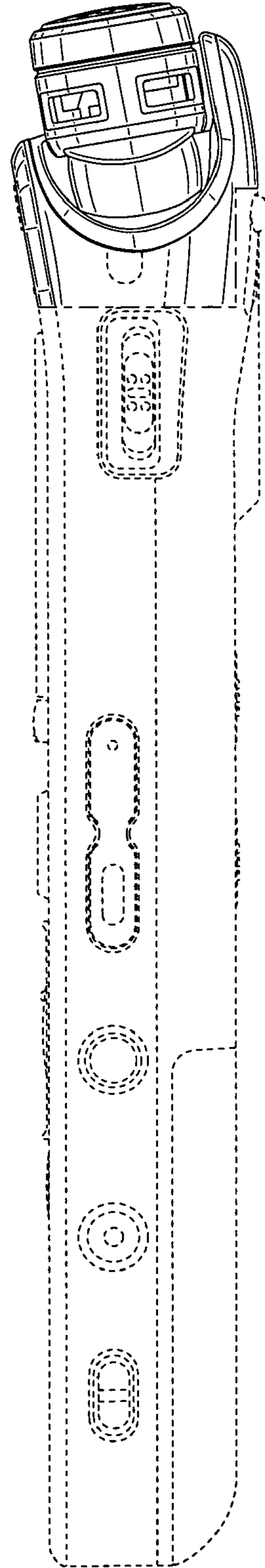

FIG.6

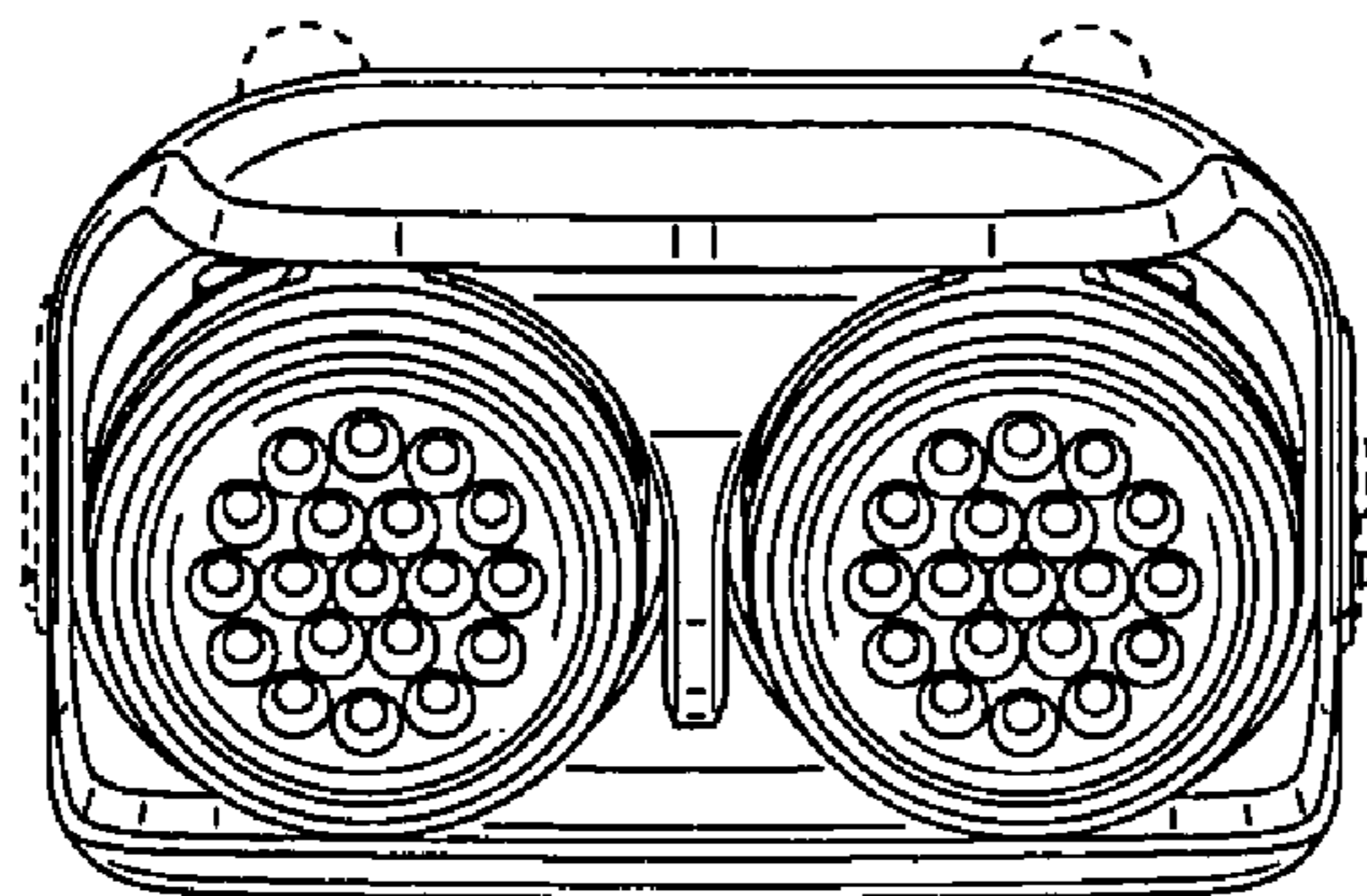

FIG.7

