



US00D649514S

(12) **United States Design Patent**
Byrne

(10) **Patent No.:** **US D649,514 S**

(45) **Date of Patent:** **** Nov. 29, 2011**

(54) **POWER AND DATA CENTER**

(76) Inventor: **Norman R. Byrne**, Ada, MI (US)

(**) Term: **14 Years**

(21) Appl. No.: **29/343,190**

(22) Filed: **Sep. 9, 2009**

Related U.S. Application Data

(63) Continuation of application No. 29/280,798, filed on Jun. 7, 2007, now abandoned.

(51) **LOC (9) Cl.** **13-03**

(52) **U.S. Cl.** **D13/139.4**

(58) **Field of Classification Search** D13/139.1, D13/139.2, 139.3, 139.4, 139.5, 139.6, 139.7, D13/139.8, 138.1, 138.2, 123, 133, 137.1, D13/137.2, 184, 137.3, 137.4, 124, 160, 162, D13/164, 178, 154, 156, 107, 110, 145, 177; D14/433, 256; D8/350, 353; 174/53, 55, 174/56, 59, 66, 494, 153 G, 152 G, 154, 167, 174/168, 650, 656; 439/105, 43, 53, 374, 439/894, 46, 55, 63, 92, 93, 95, 101, 102, 439/106, 107, 108, 135, 149, 222, 266, 285, 439/291, 300, 344, 373, 535, 620.21, 638, 439/660, 907, 650, 651, 652, 653, 654; 361/42
See application file for complete search history.

(56) **References Cited**

U.S. PATENT DOCUMENTS

D353,363 S 12/1994 Toby
D392,254 S 3/1998 Gevaert
6,028,267 A 2/2000 Byrne
6,290,518 B1 9/2001 Byrne

D455,123 S 4/2002 Gershfeld
D455,716 S 4/2002 Gershfeld
D457,137 S 5/2002 Gershfeld
D472,213 S 3/2003 Byrne
6,923,663 B2 8/2005 Oddsen
7,045,706 B1 5/2006 Lincoln
D535,257 S 1/2007 Byrne
D556,139 S 11/2007 Gershfeld
7,407,392 B2 * 8/2008 Cooke et al. 439/131
D597,960 S * 8/2009 Dinh et al. D13/152
7,614,889 B1 * 11/2009 Black et al. 439/142
2004/0147147 A1 7/2004 Griepentrog
2004/0238197 A1 12/2004 Gates, II

* cited by examiner

Primary Examiner — Angela J Lee

(74) *Attorney, Agent, or Firm* — Varnum, Riddering, Schmidt & Howlett LLP

(57) **CLAIM**

The ornamental design for a power and data center, as shown and described.

DESCRIPTION

FIG. 1 is a rear view of my power and data center in accordance with the invention;
FIG. 2 is a top plan view thereof;
FIG. 3 is a left side elevation view thereof;
FIG. 4 is a front elevation view thereof;
FIG. 5 is a right side elevation view thereof;
FIG. 6 is a bottom view thereof;
FIG. 7 is a perspective view thereof; and,
FIG. 8 is another perspective view thereof, but shown in a closed position.
The portions of the power and data center shown in broken lines form no part of the claimed design.

1 Claim, 2 Drawing Sheets

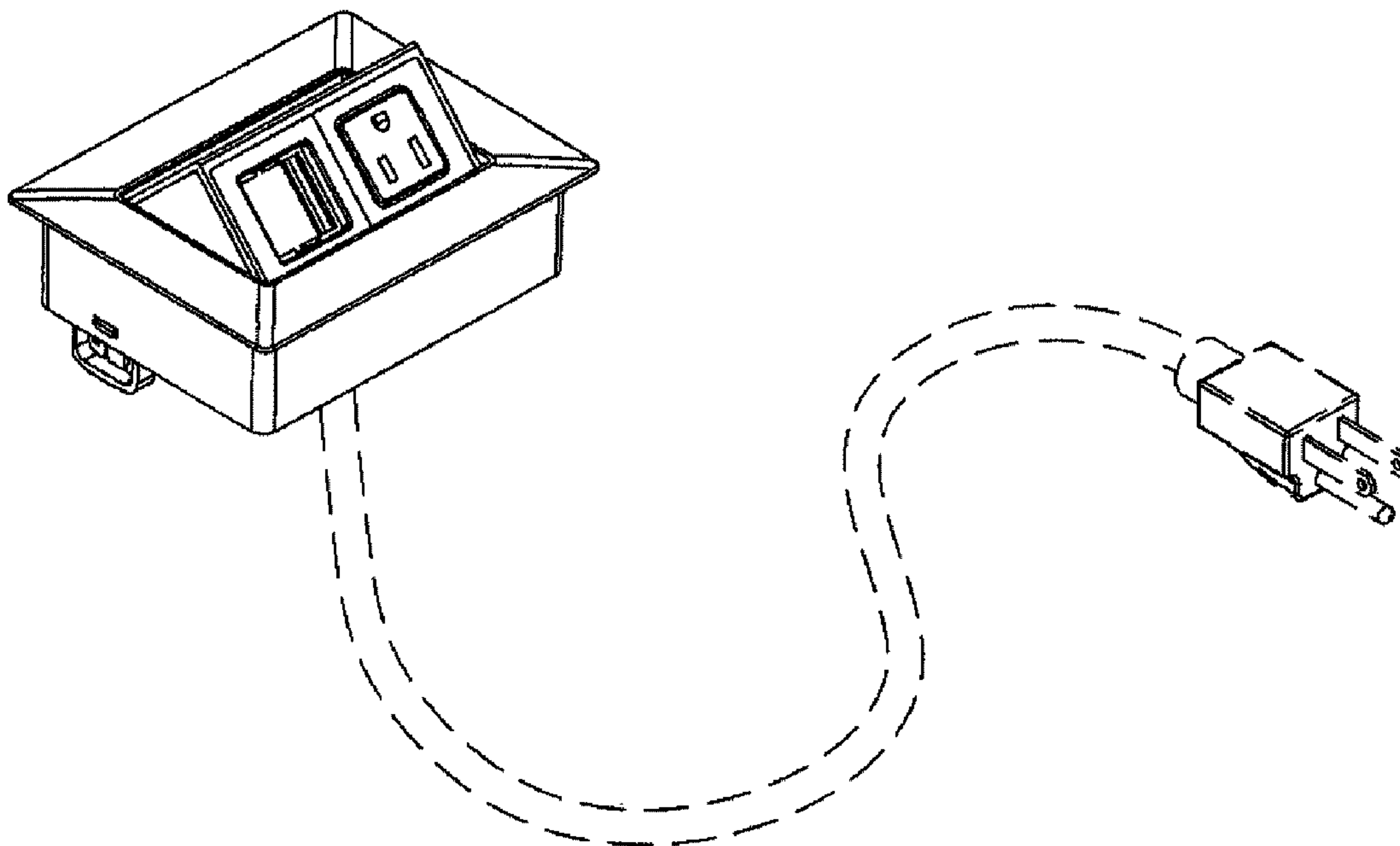

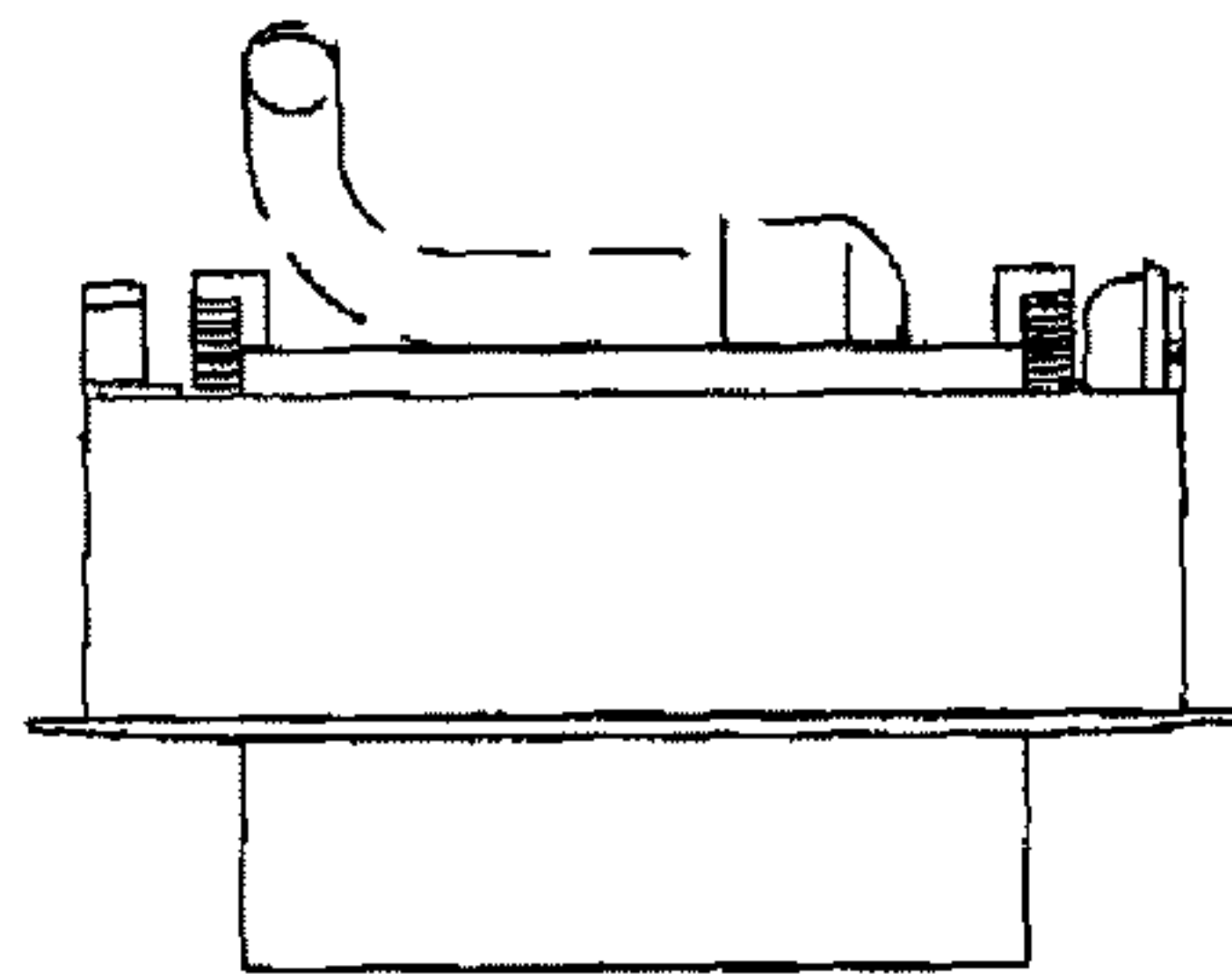

Fig. 1

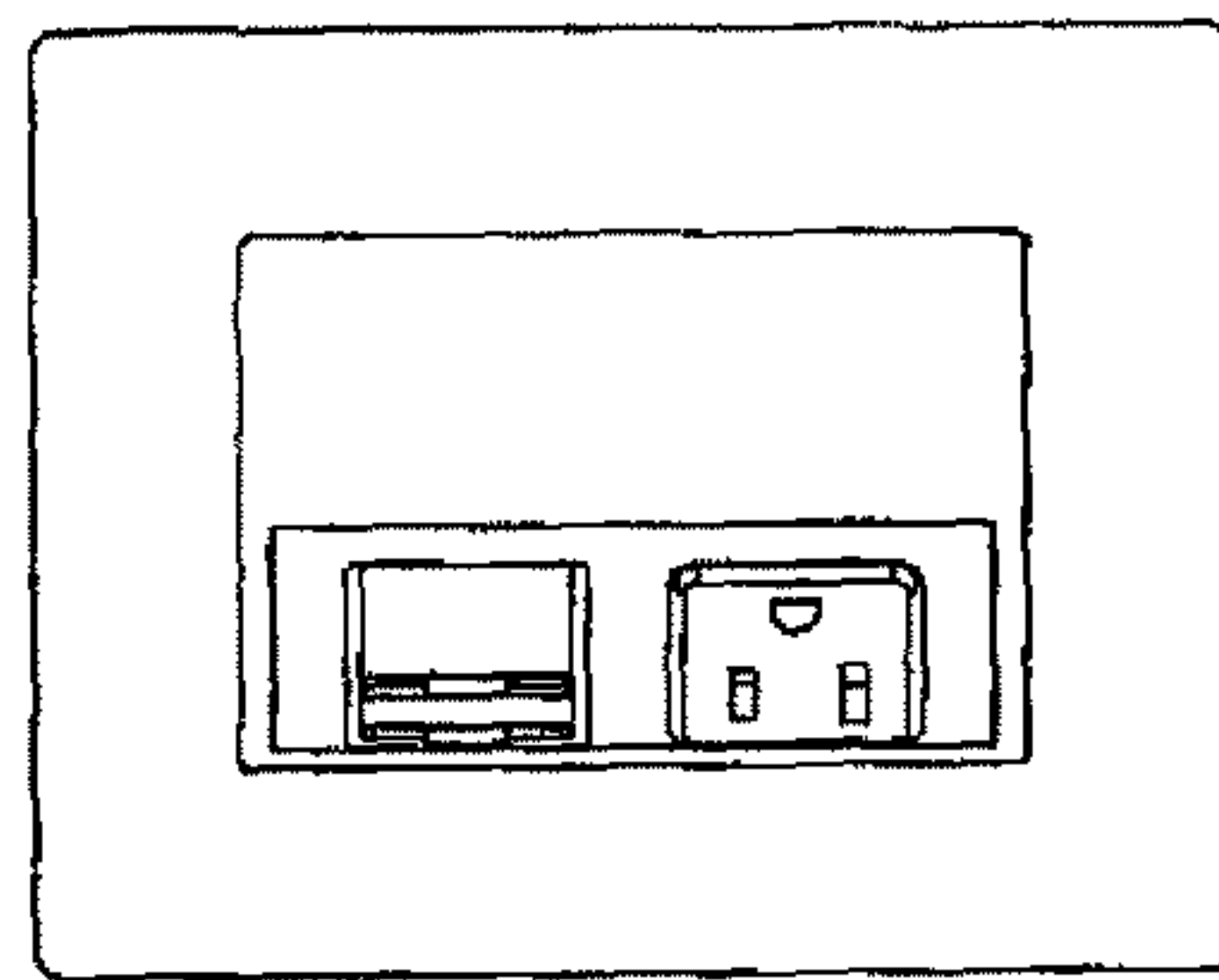

Fig. 2

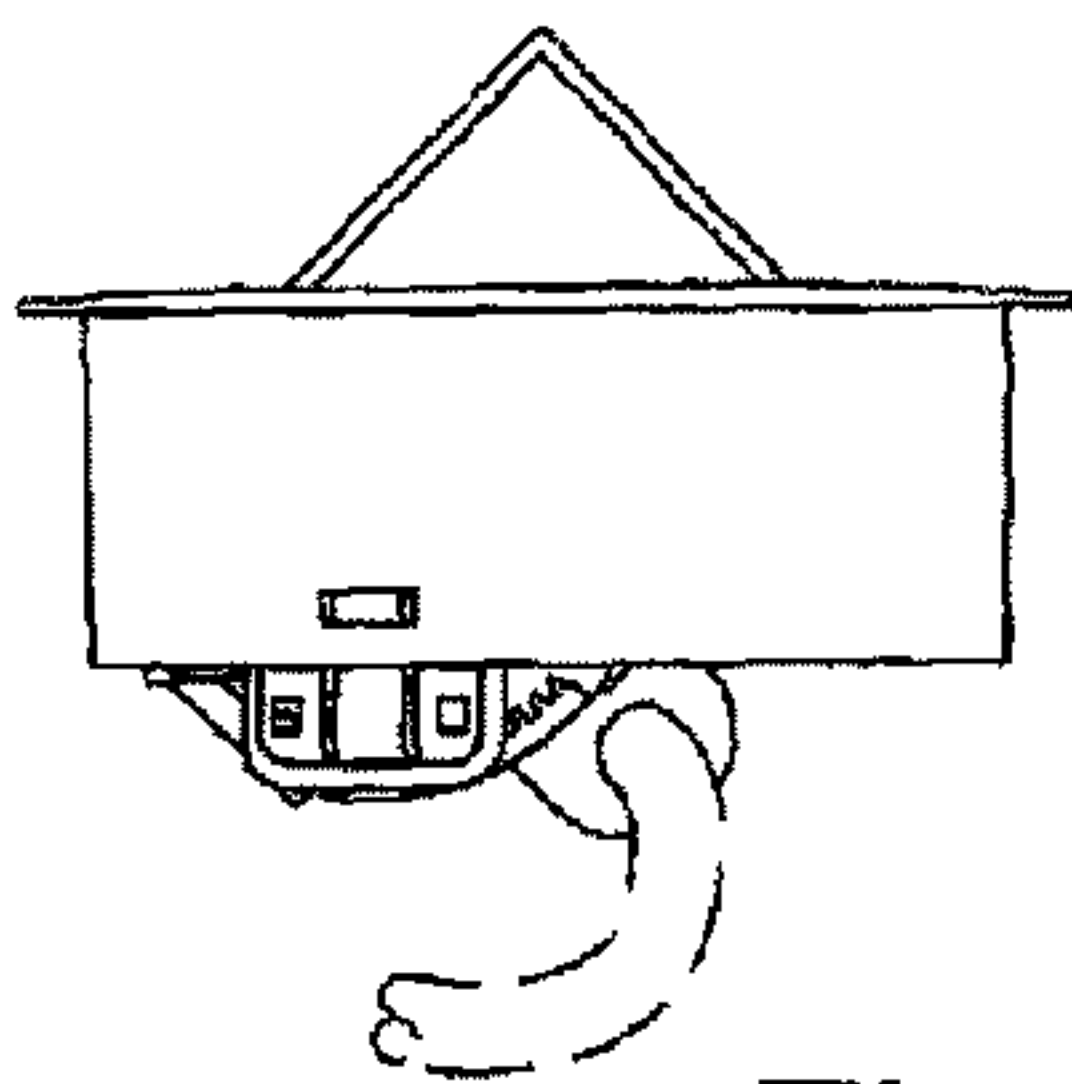

Fig. 3

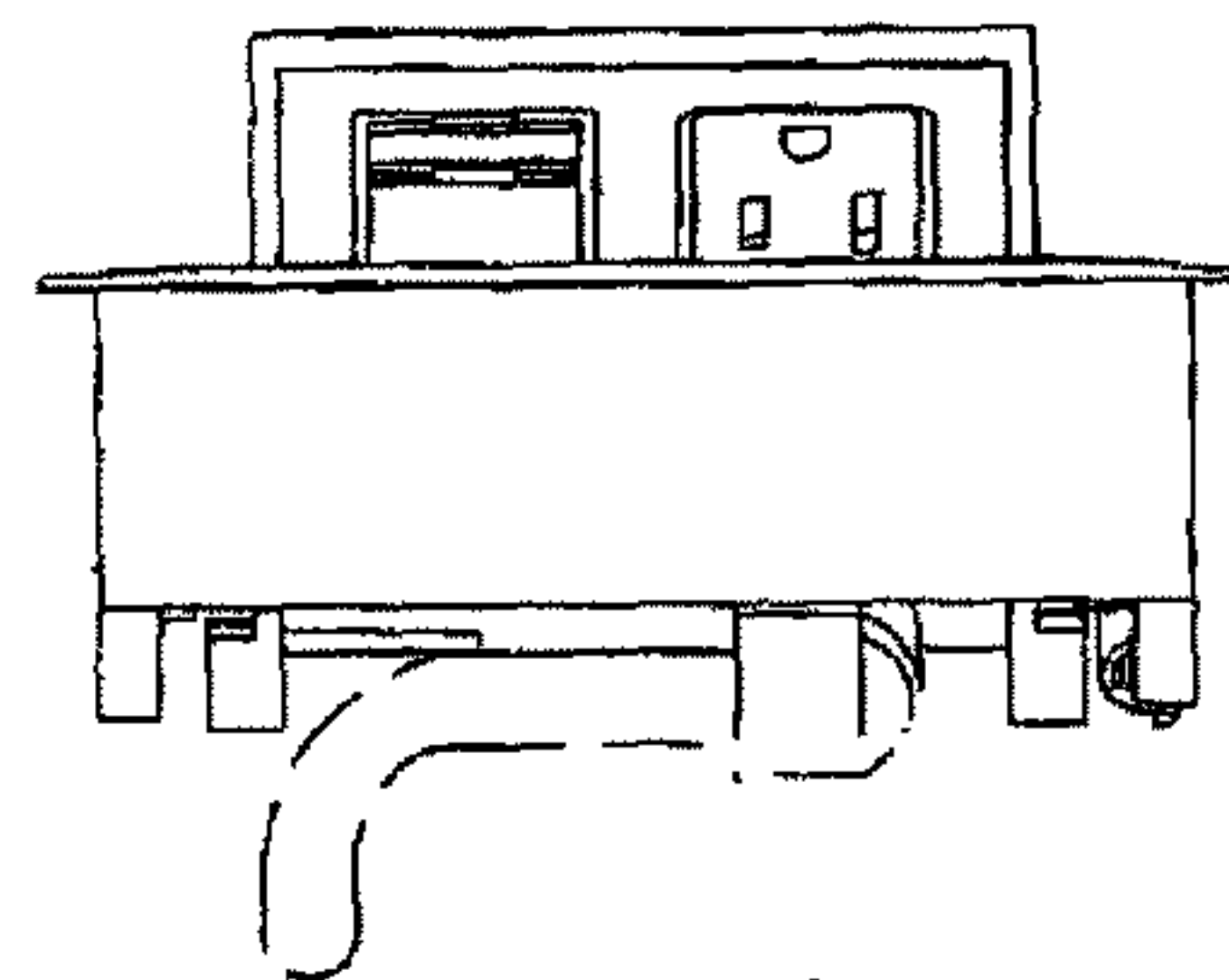

Fig. 4

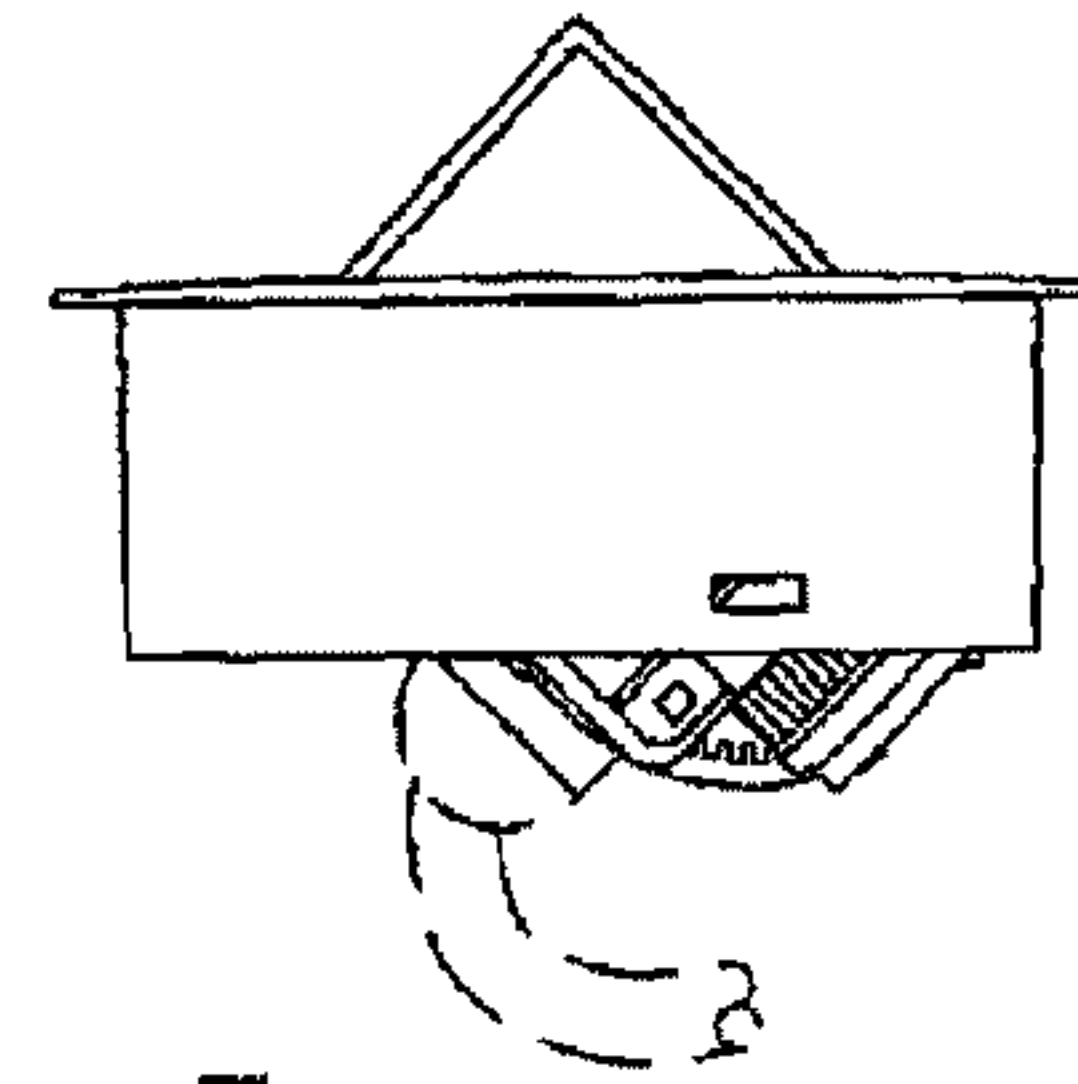

Fig. 5

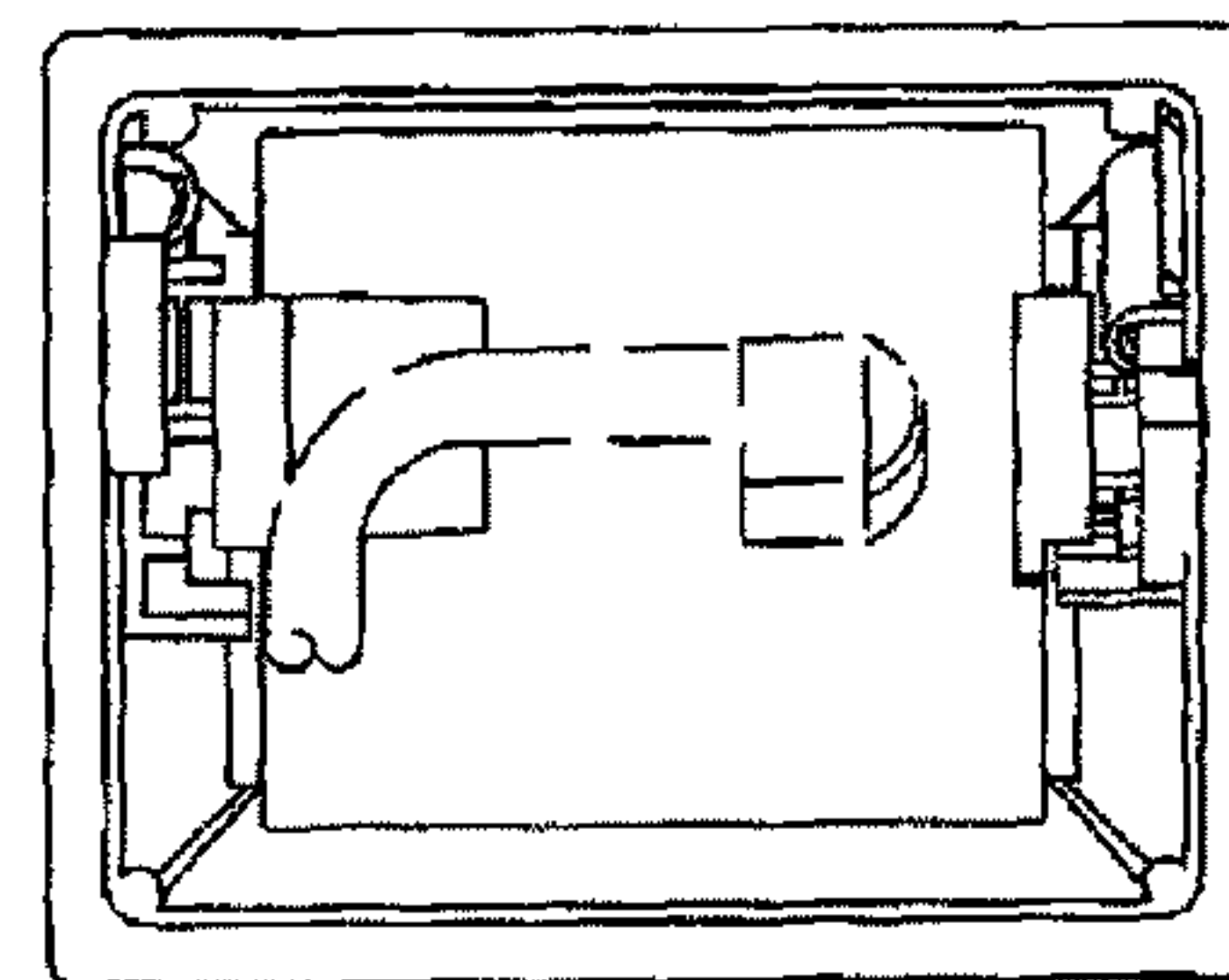

Fig. 6

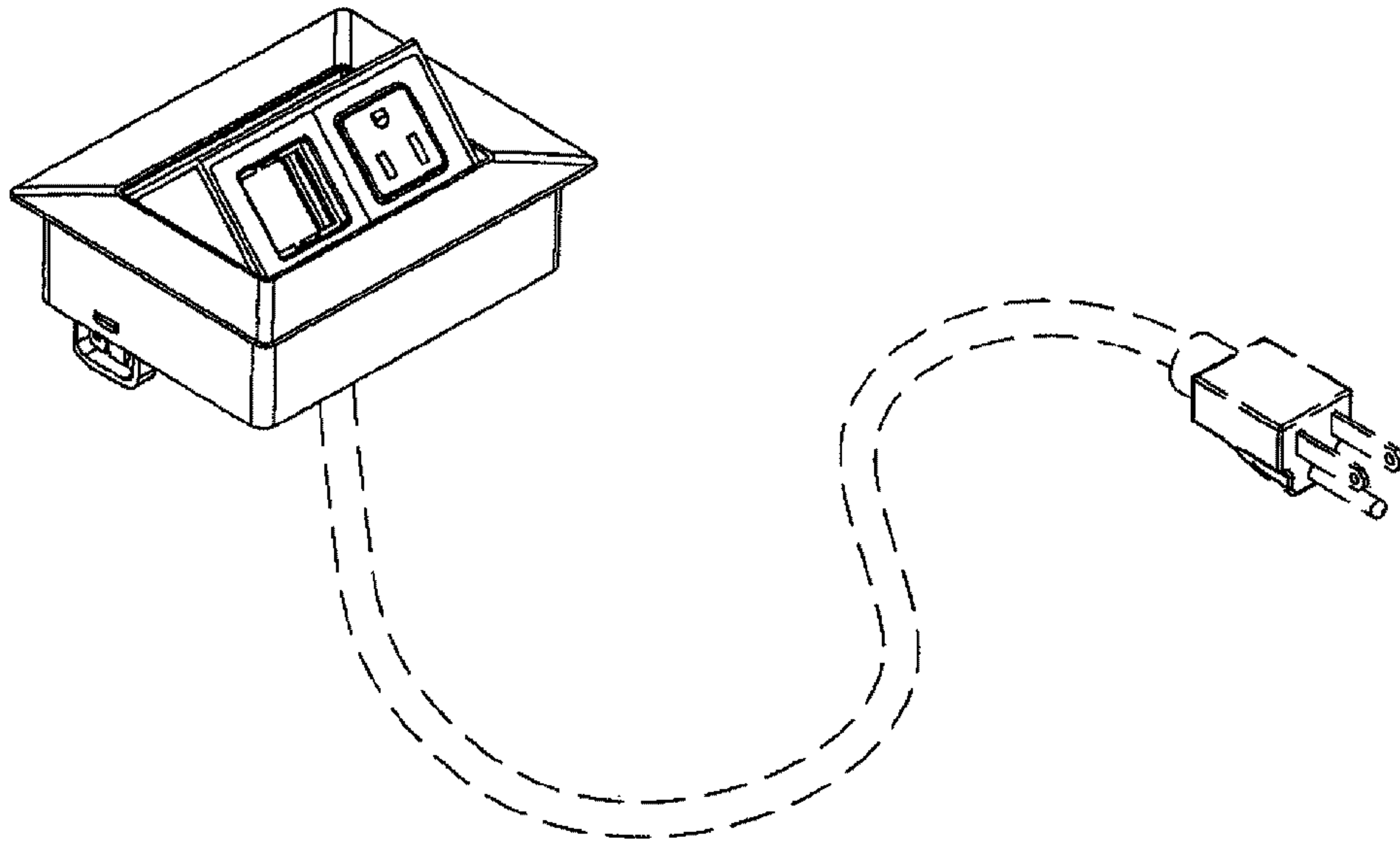

Fig. 7

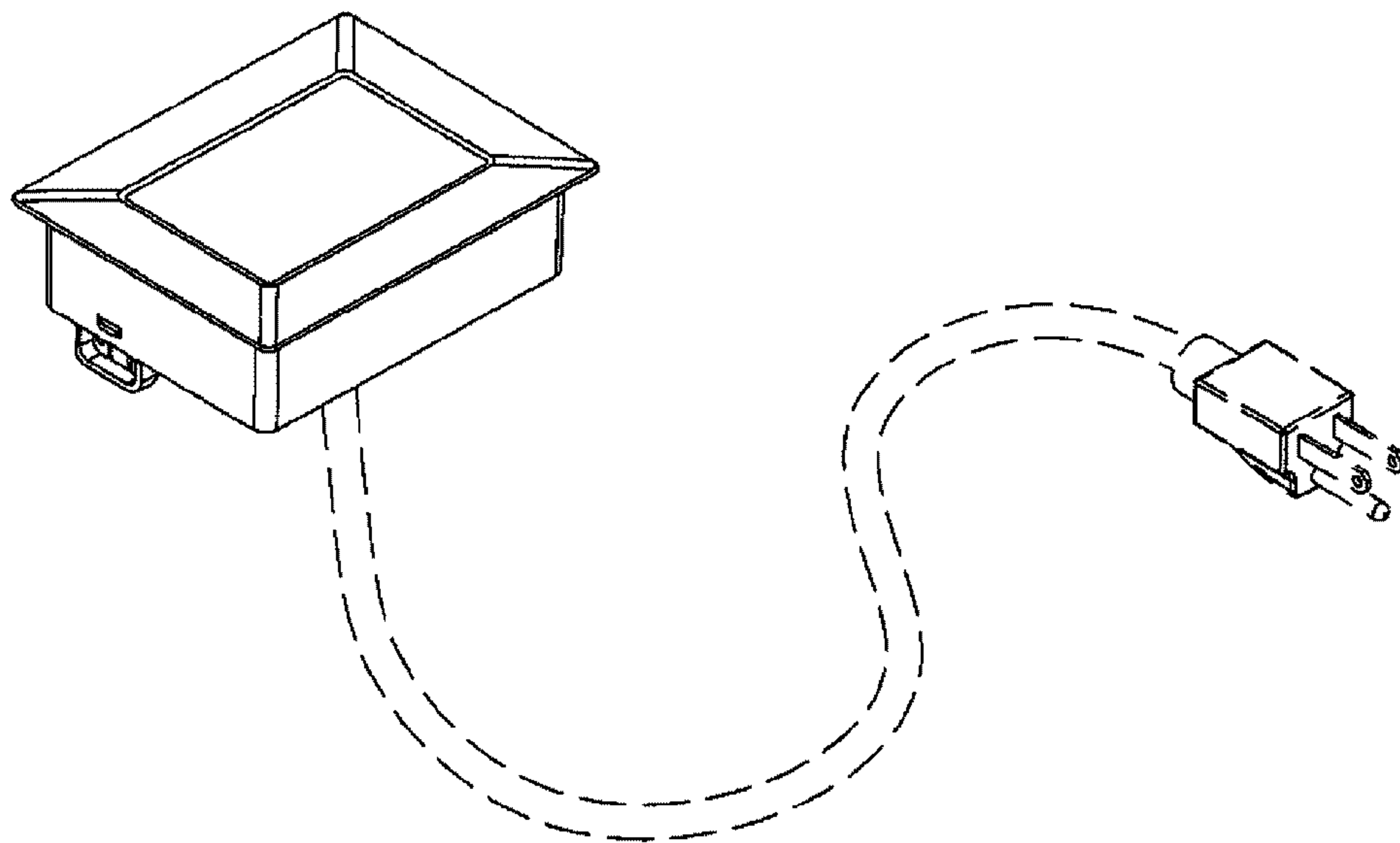

Fig. 8