



US00D649406S

(12) **United States Design Patent**
Caldwell et al.

(10) **Patent No.:** **US D649,406 S**
(45) **Date of Patent:** **** Nov. 29, 2011**

(54) **DISPENSER**
(75) Inventors: **Craig Caldwell**, Slippery Rock, PA
(US); **John Marshall**, Pittsburgh, PA
(US); **William Rasile**, Allison Park, PA
(US)

(73) Assignee: **H.J. Heinz Company**, Pittsburgh, PA
(US)

(**) Term: **14 Years**

(21) Appl. No.: **29/364,647**

(22) Filed: **Jun. 25, 2010**

(51) **LOC (9) Cl.** **07-06**

(52) **U.S. Cl.** **D7/600.1**

(58) **Field of Classification Search** D7/590,
D7/600.1-600.4; D6/540, 553, 567, 515;
211/13.1, 70.6, 70.7, 87.01, 89.01; 248/200,
248/205.5, 309.1, 314

See application file for complete search history.

(56) **References Cited**

U.S. PATENT DOCUMENTS

2,705,579 A	4/1955	Mason	
2,898,003 A	8/1959	Wilson et al.	
3,315,801 A	4/1967	Lowry	
3,370,757 A	2/1968	Foster	
3,407,969 A	10/1968	Klein et al.	
3,453,661 A	7/1969	Repko	
3,660,960 A	5/1972	Inman	
3,722,754 A	3/1973	Struble	
3,873,735 A	3/1975	Chalin et al.	
4,090,660 A	5/1978	Schram et al.	
4,301,926 A	11/1981	Chung	
4,463,869 A	8/1984	Lewis	
4,566,613 A	1/1986	Anscomb	
4,648,506 A	3/1987	Campbell	
D289,841 S *	5/1987	Braun	D6/515
4,673,085 A	6/1987	Badouard et al.	
4,717,046 A	1/1988	Brogli	

D297,198 S *	8/1988	Liebe et al.	D7/590
4,762,124 A	8/1988	Kerch et al.	
4,765,463 A	8/1988	Chanel	
4,863,036 A	9/1989	Heijenga	
4,871,091 A	10/1989	Preziosi	
4,872,597 A	10/1989	Hanafusa	
D306,808 S *	3/1990	Thomas	D6/515
4,921,137 A	5/1990	Heijenga	
4,963,045 A	10/1990	Willcox	
4,989,419 A	2/1991	Brando et al.	
D317,690 S	6/1991	Thomsen	
D318,795 S	8/1991	Christine	
5,038,974 A	8/1991	DaCosta	
5,111,932 A	5/1992	Campbell	
5,141,136 A	8/1992	Tignor	
5,156,329 A	10/1992	Farrell	
5,235,149 A	8/1993	Boehrer	
5,277,920 A	1/1994	Weaver, Jr.	

(Continued)

FOREIGN PATENT DOCUMENTS

FR 2801570 6/2001

(Continued)

Primary Examiner — Terry Wallace

(74) *Attorney, Agent, or Firm* — Duane Morris LLP

(57) **CLAIM**

The ornamental design for a dispenser, as shown and described.

DESCRIPTION

FIG. 1 is a perspective view of the dispenser;
FIG. 2 is a front view of the dispenser;
FIG. 3 is a rear view of the dispenser;
FIG. 4 is a left side view of the dispenser;
FIG. 5 is a right side view of the dispenser;
FIG. 6 is a top view of the dispenser; and,
FIG. 7 is a bottom view of the dispenser.
The broken line showing of structure is for illustrative purposes only, and forms no part of the claimed design.

1 Claim, 3 Drawing Sheets

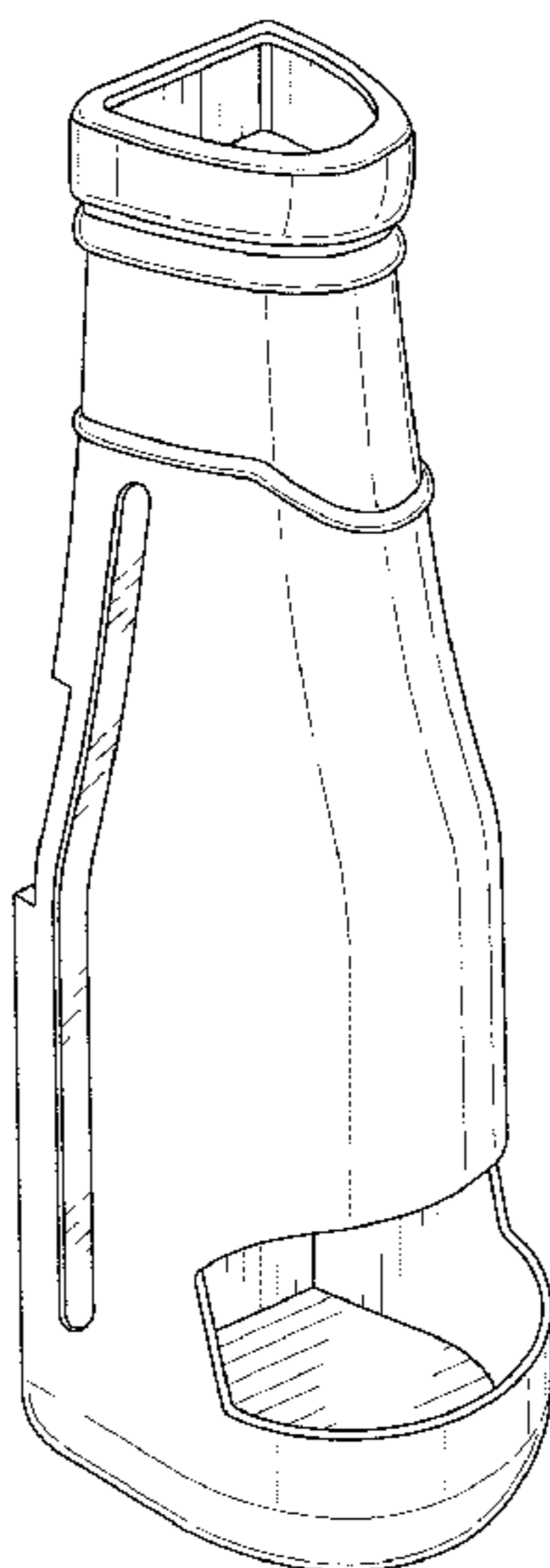

US D649,406 S

Page 2

U.S. PATENT DOCUMENTS

D354,906 S 1/1995 Lane, Jr. et al.
5,411,178 A 5/1995 Roders et al.
D362,595 S 9/1995 Schneider
5,482,172 A 1/1996 Braddock
5,529,224 A 6/1996 Chan et al.
5,546,728 A 8/1996 Dekeyser
5,613,517 A 3/1997 Handler
5,662,245 A 9/1997 Grant
5,706,961 A 1/1998 Morano
5,799,838 A 9/1998 Miller
5,806,726 A 9/1998 Ho
5,839,609 A 11/1998 Zakensberg
5,996,845 A 12/1999 Chan
6,007,264 A 12/1999 Koptis
6,051,263 A 4/2000 Gorlich et al.
6,062,413 A 5/2000 Redmond
6,085,942 A 7/2000 Redmond
6,089,375 A 7/2000 Johnson et al.
D435,440 S 12/2000 Croft et al.
6,220,311 B1 4/2001 Litto
D442,078 S 5/2001 Fuquen
D448,661 S 10/2001 Kerr et al.
6,357,631 B1 3/2002 Zaksenberg
6,419,118 B1 7/2002 Rees et al.
6,435,374 B1 8/2002 Tabaroni
6,460,781 B1 10/2002 Garcia et al.
6,557,731 B1 5/2003 Lyon et al.
6,601,737 B1 8/2003 Sandler
6,648,140 B2 11/2003 Petricca
6,663,019 B2 12/2003 Garcia et al.

D484,972 S 1/2004 Steele, IV et al.
6,702,462 B2 3/2004 Richardson
6,811,057 B2 11/2004 Duquet et al.
6,854,888 B1 2/2005 Brown et al.
6,863,178 B2 3/2005 Sokolsky et al.
D505,861 S 6/2005 Risgalla
6,955,028 B1 10/2005 Dunaway
7,004,322 B1 2/2006 Bartoli
D537,341 S 2/2007 Liebe et al.
RE39,520 E 3/2007 Hess, III et al.
D580,782 S 11/2008 Murray
D585,224 S * 1/2009 Hwang D6/553
7,506,762 B2 3/2009 Nelson et al.
D598,299 S 8/2009 Isogai et al.
2001/0045374 A1 11/2001 Selker
2002/0100760 A1 8/2002 Rinks
2002/0148855 A1 10/2002 Sokolsky et al.
2003/0015605 A1 1/2003 Garcia et al.
2003/0183637 A1 10/2003 Zappa et al.
2006/0278562 A1 12/2006 Van Puijenbroek
2007/0034647 A1 2/2007 Patrick
2007/0164045 A1 7/2007 Wydler et al.
2007/0228073 A1 10/2007 Mazzarino
2010/0008602 A1 1/2010 Risgalla

FOREIGN PATENT DOCUMENTS

WO WO9728054 8/1997
WO WO02070352 9/2002
WO WO2004063048 7/2004
WO WO2007126817 11/2007

* cited by examiner

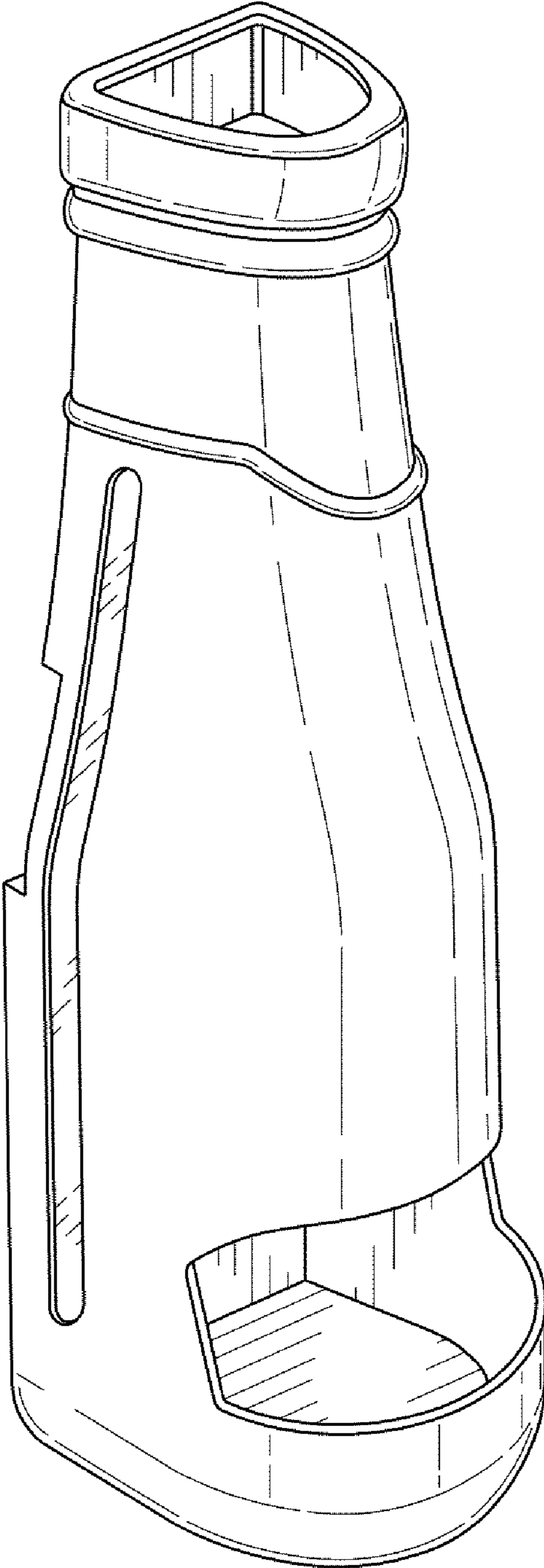

FIG. 1



FIG. 2

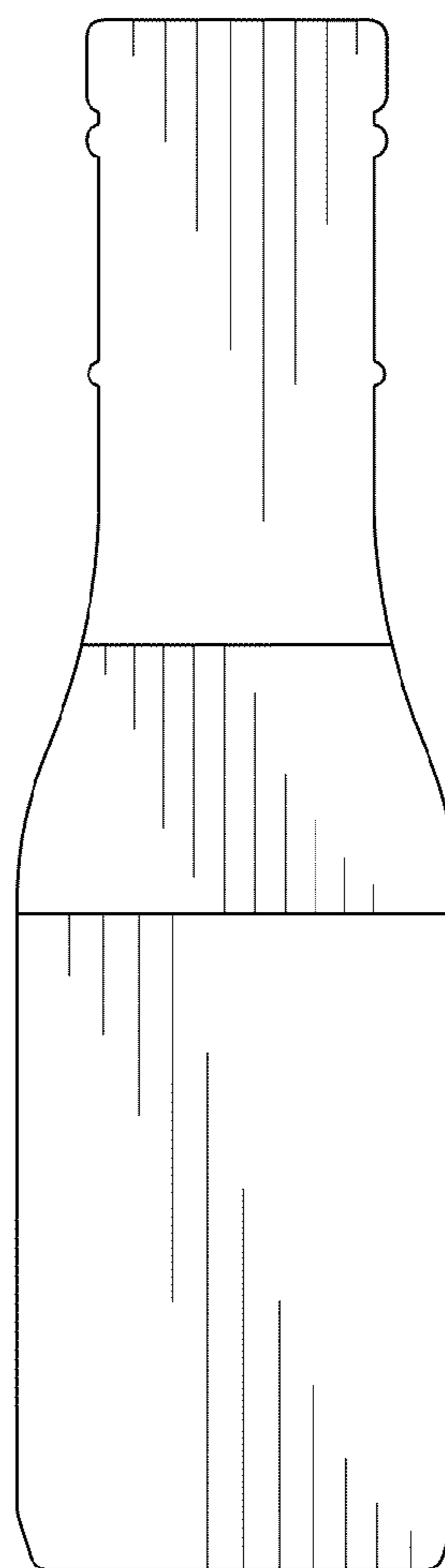

FIG. 3

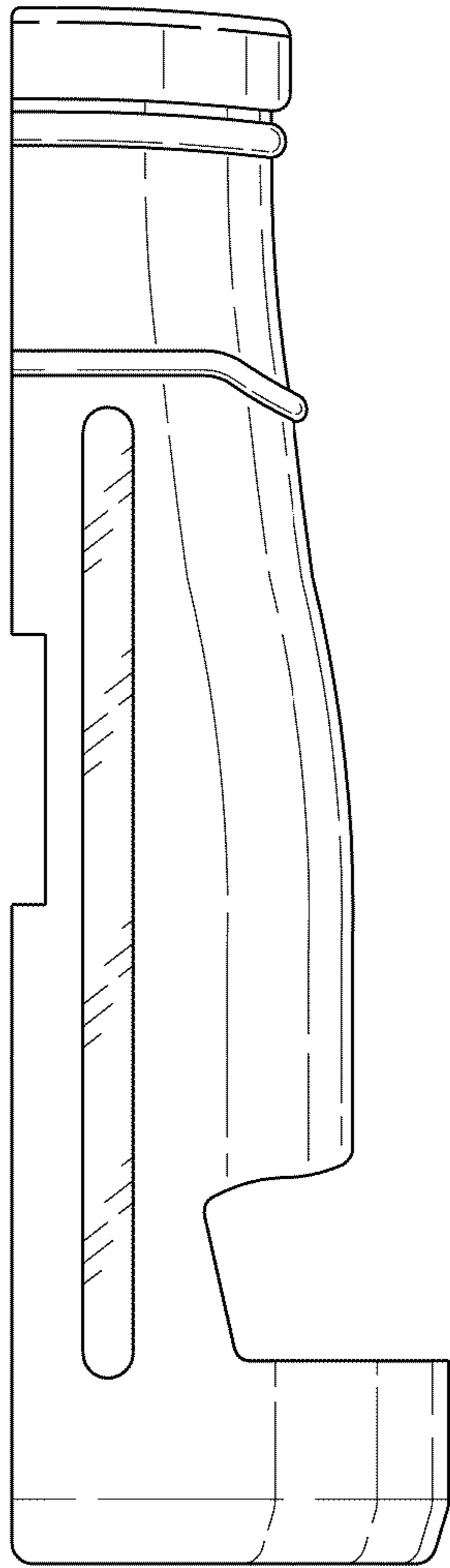

FIG. 4

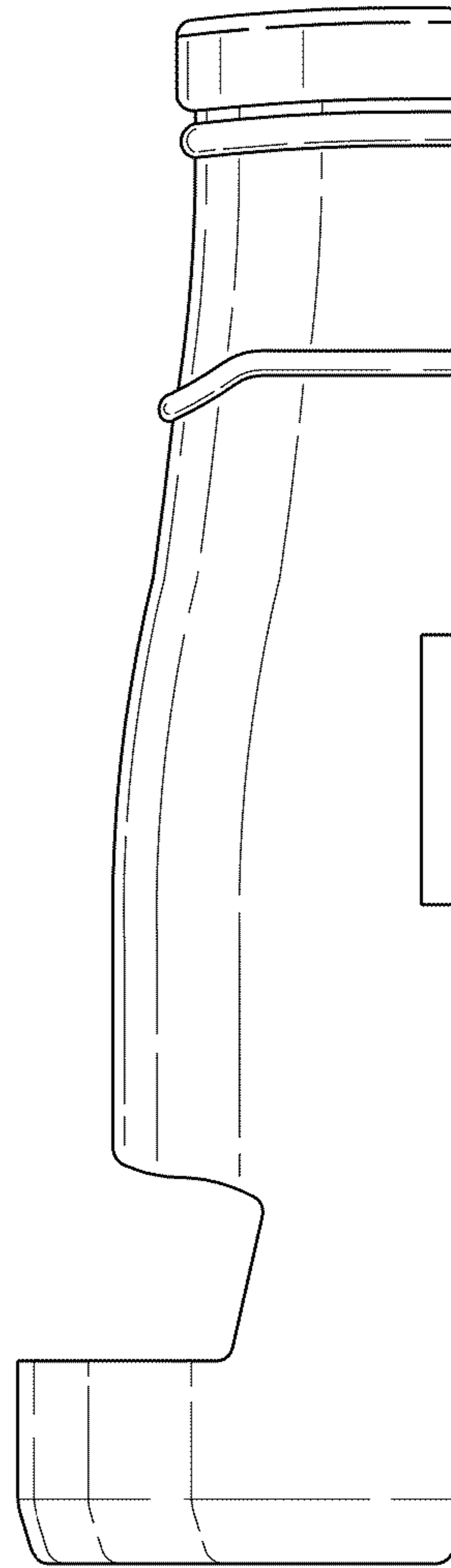

FIG. 5

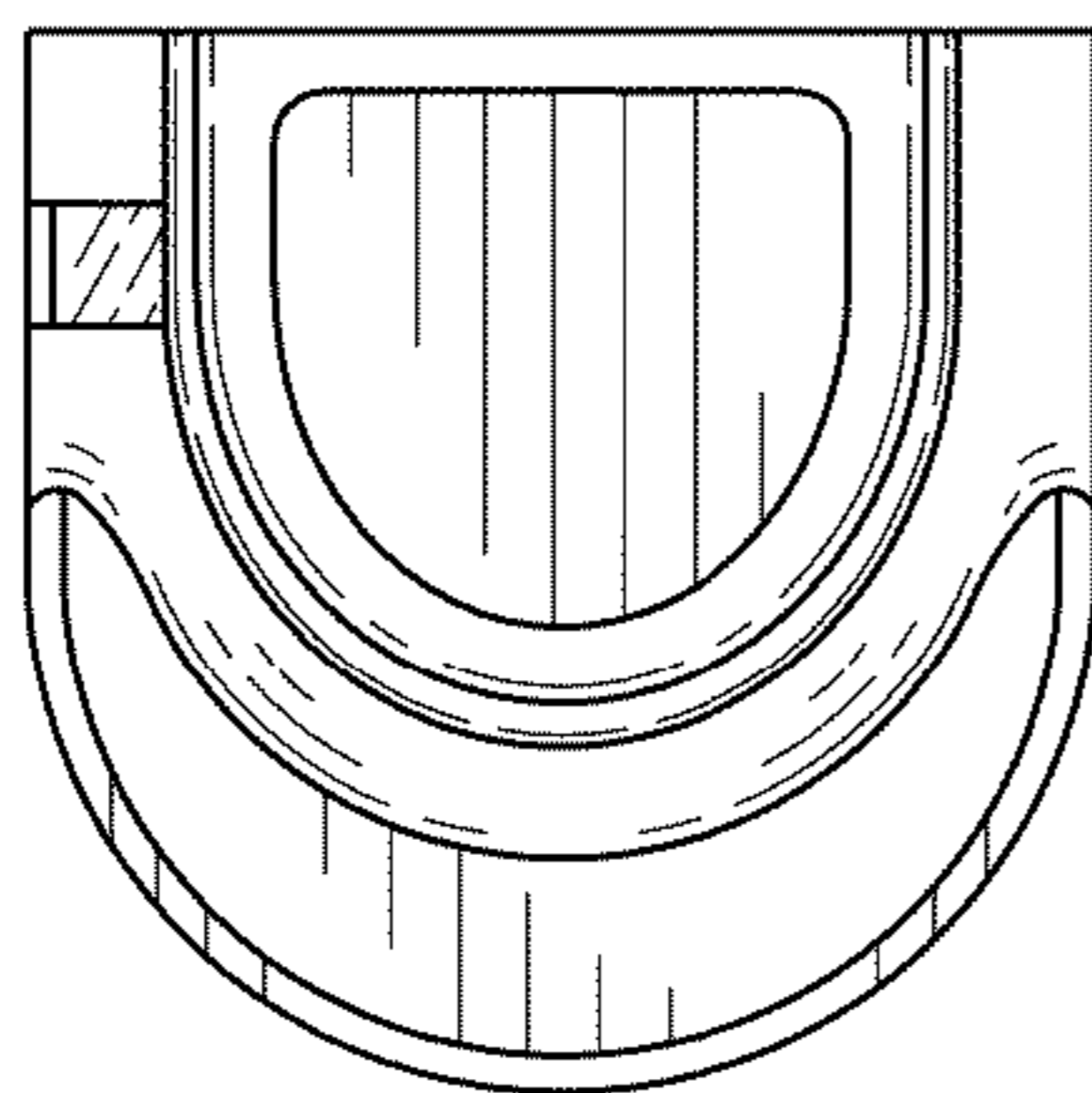

FIG. 6

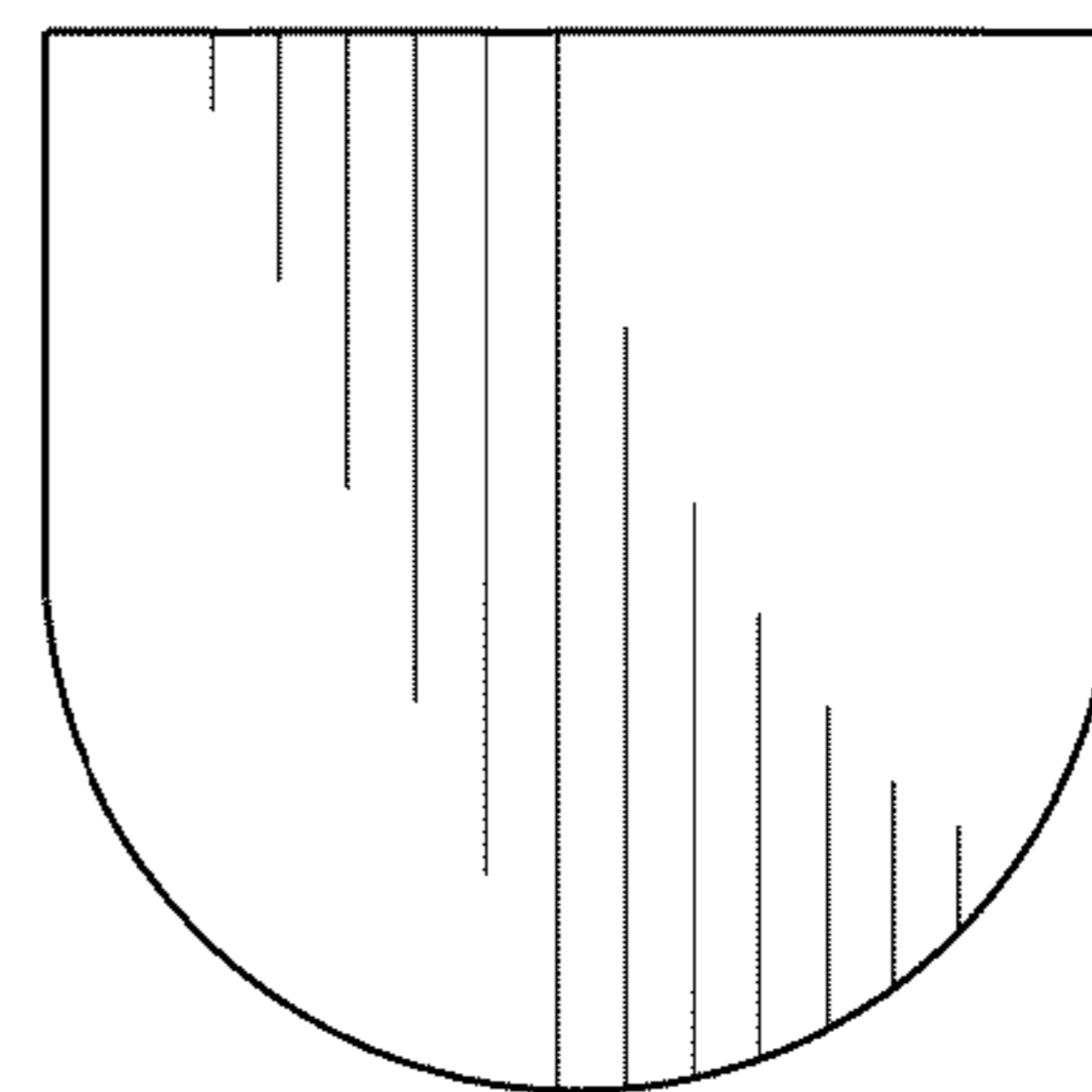

FIG. 7