



US00D649394S

(12) **United States Design Patent**
Grabes et al.

(10) **Patent No.:** **US D649,394 S**

(45) **Date of Patent:** **** Nov. 29, 2011**

(54) **HAND BLENDER**

(75) Inventors: **Oliver Grabes**, Frankfurt (DE); **Phong Duy Vu**, Schwalbach (DE); **Sven Wuttig**, Griesheim (DE)

(73) Assignee: **The Procter & Gamble Company**, Cincinnati, OH (US)

(**) **Term:** **14 Years**

(21) **Appl. No.:** **29/392,907**

(22) **Filed:** **May 27, 2011**

(30) **Foreign Application Priority Data**

Mar. 16, 2011 (WO) 592395401

(51) **LOC (9) Cl.** **31-00**

(52) **U.S. Cl.** **D7/379; D7/376; D7/380**

(58) **Field of Classification Search** D7/305-311, D7/317-318, 368, 372, 376-386, 391, 412-415, D7/665; 99/326, 348, 508-511; 241/30-37.5, 241/101.01-101.2, 166-169.1, 285.1-285.3, 241/291, 292.1; 366/64-67, 98, 129, 142, 366/197-211, 241-254, 279-292, 341-347; 416/75-76, 70 R, 163

See application file for complete search history.

(56) **References Cited**

U.S. PATENT DOCUMENTS

D345,076 S *	3/1994	Saltet	D7/376
D348,587 S *	7/1994	Saltet	D7/376
D358,293 S *	5/1995	Sebastia	D7/376
D361,241 S *	8/1995	Littmann	D7/376
D383,938 S *	9/1997	Littmann	D7/376
D392,504 S *	3/1998	Lallemand	D7/376
D394,367 S *	5/1998	Littmann	D7/379
D398,809 S *	9/1998	Henderson	D7/376
D400,756 S *	11/1998	Henderson	D7/376
D408,214 S *	4/1999	Cousins	D7/376
D425,368 S *	5/2000	Littmann	D7/412

D426,105 S *	6/2000	Littmann	D7/376
D437,184 S *	2/2001	Cruz	D7/379
D447,380 S *	9/2001	Feil	D7/376
D447,381 S *	9/2001	Littmann	D7/381
D456,206 S *	4/2002	Feil	D7/376
6,398,403 B1 *	6/2002	Rebordosa et al.	366/129
D485,729 S *	1/2004	Patton et al.	D7/379
D506,102 S *	6/2005	Ikegaki	D7/379
D510,837 S *	10/2005	Lloyd et al.	D7/376
D533,022 S *	12/2006	Piret	D7/379
D534,032 S *	12/2006	Lloyd	D7/380
D572,075 S *	7/2008	Wong	D7/376
D592,447 S *	5/2009	Blaise	D7/380
2002/0034121 A1 *	3/2002	Rebordosa et al.	366/129
2008/0043569 A1 *	2/2008	Moschetti	366/279

* cited by examiner

Primary Examiner — Ricky Pham

(74) *Attorney, Agent, or Firm* — Kim William Zerby; Brent M. Peebles

(57) **CLAIM**

The ornamental design for a hand blender, as shown and described.

DESCRIPTION

FIG. 1 is a perspective view of a hand blender; FIG. 2 is a front view thereof; FIG. 3 is a right side view thereof; FIG. 4 is a rear view thereof; FIG. 5 is a left side view thereof; FIG. 6 is a top plan view thereof; FIG. 7 is a bottom view thereof. FIG. 8 is a perspective view of a handpiece of the hand blender; shown separately for completeness of illustration; FIG. 9 is a front view thereof; FIG. 10 is a right side view thereof; FIG. 11 is a rear view thereof; FIG. 12 is a left side view thereof; FIG. 13 is a top plan view thereof; and, FIG. 14 is a bottom view thereof.

1 Claim, 4 Drawing Sheets

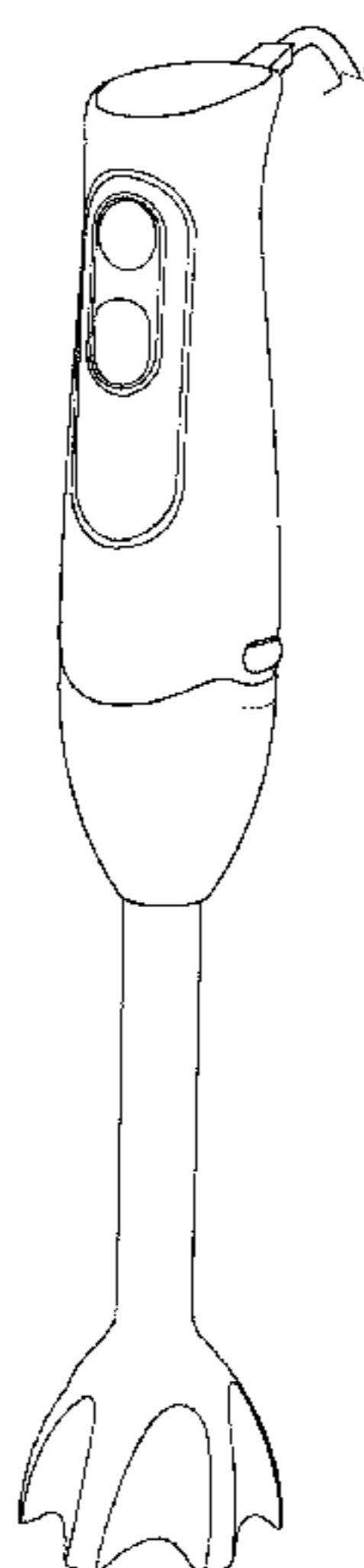

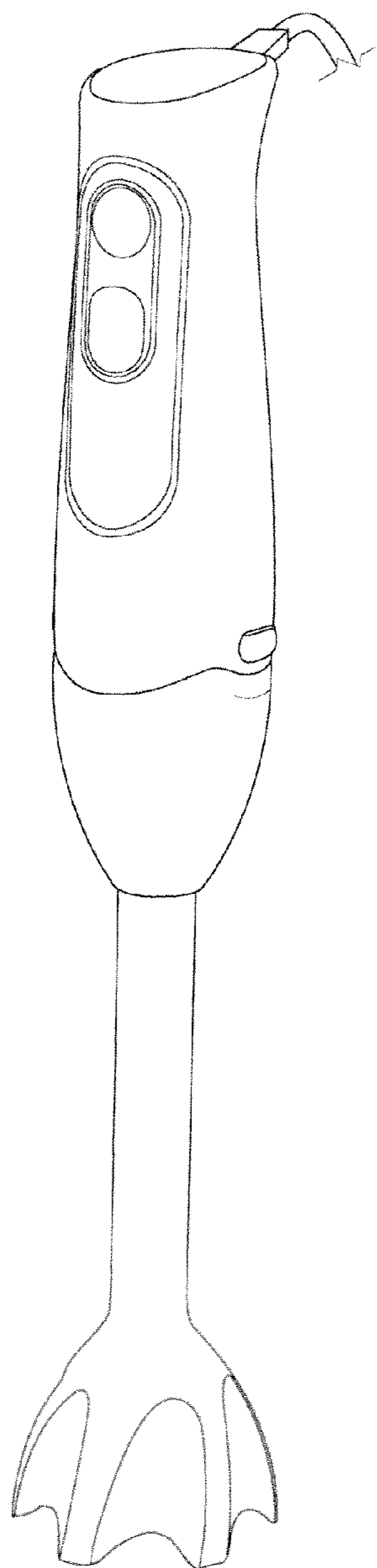

Fig. 1

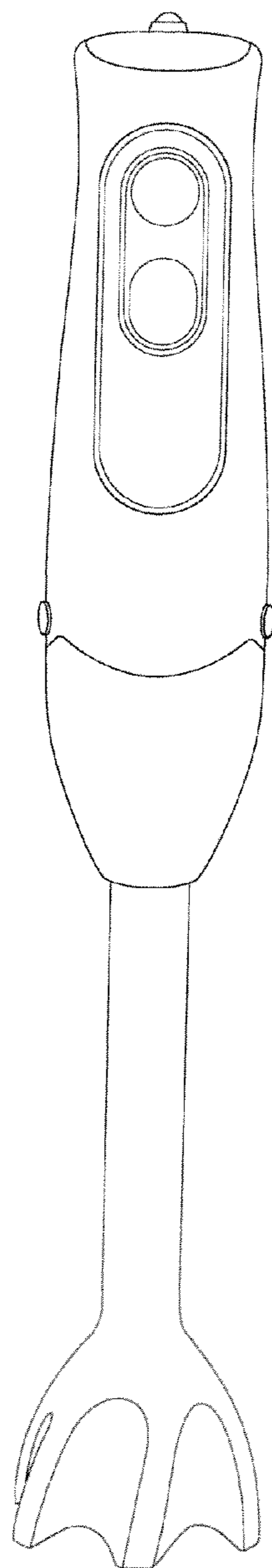

Fig. 2

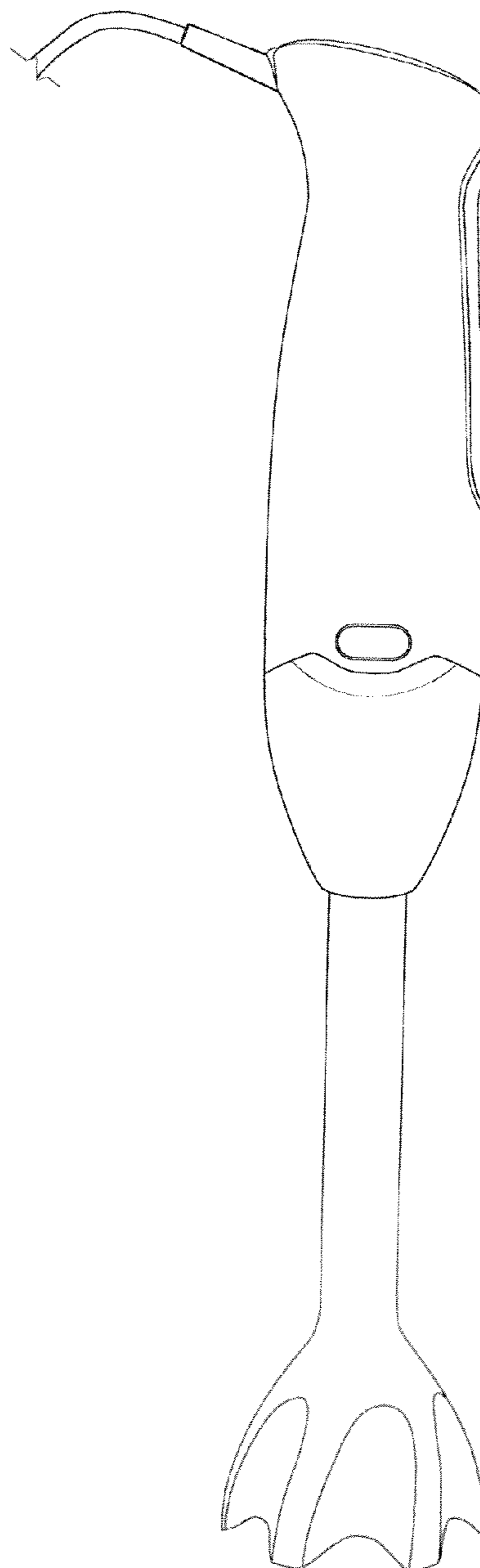

Fig. 3

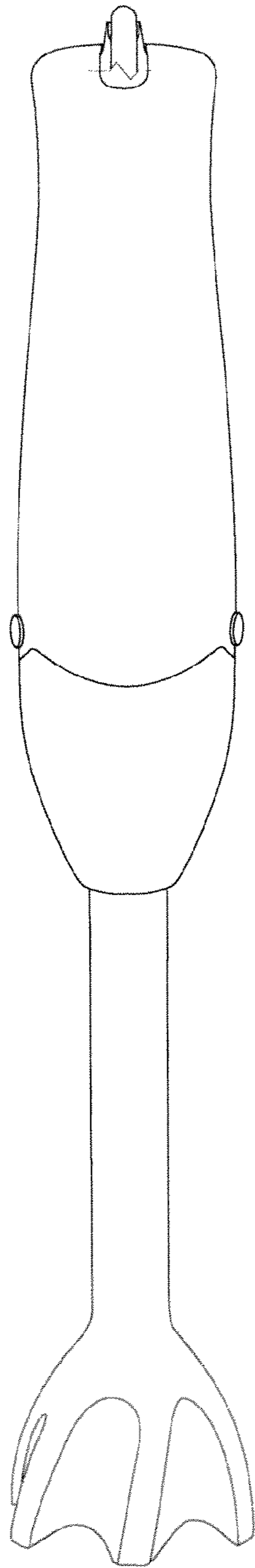

Fig. 4

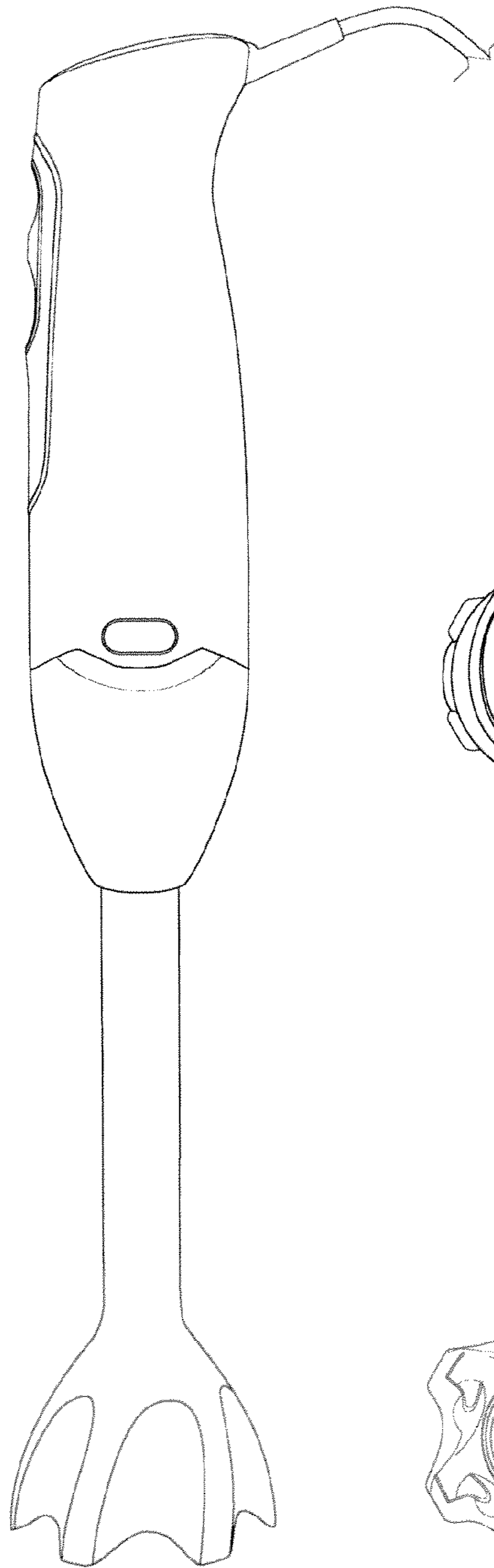

Fig. 5

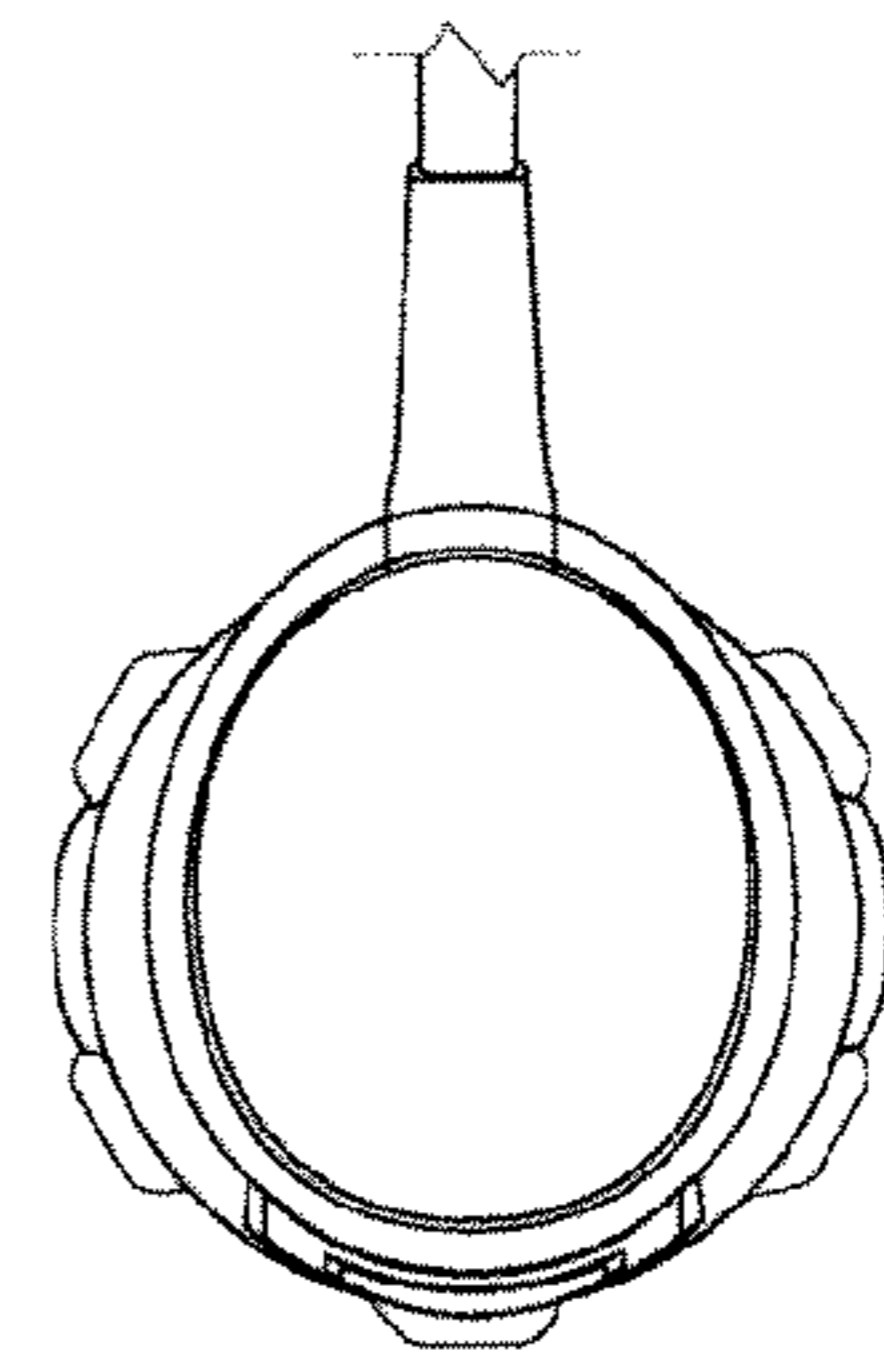

Fig. 6

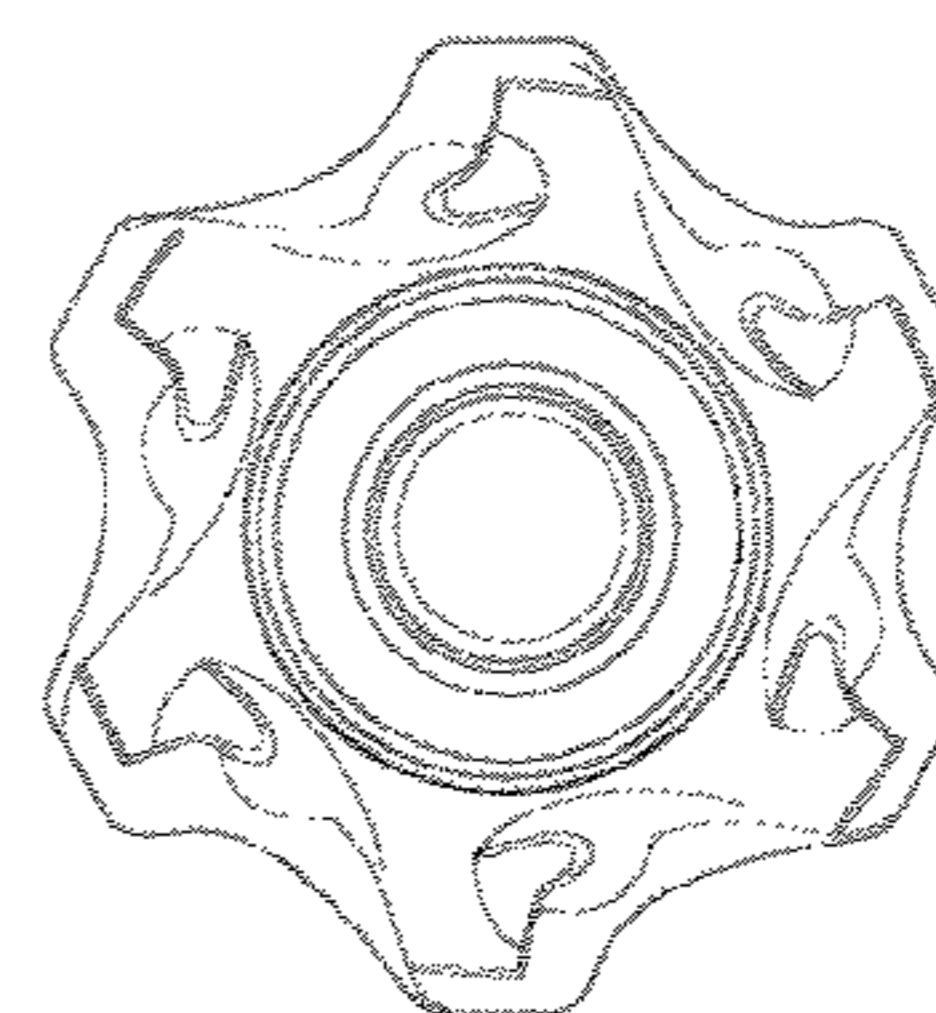

Fig. 7

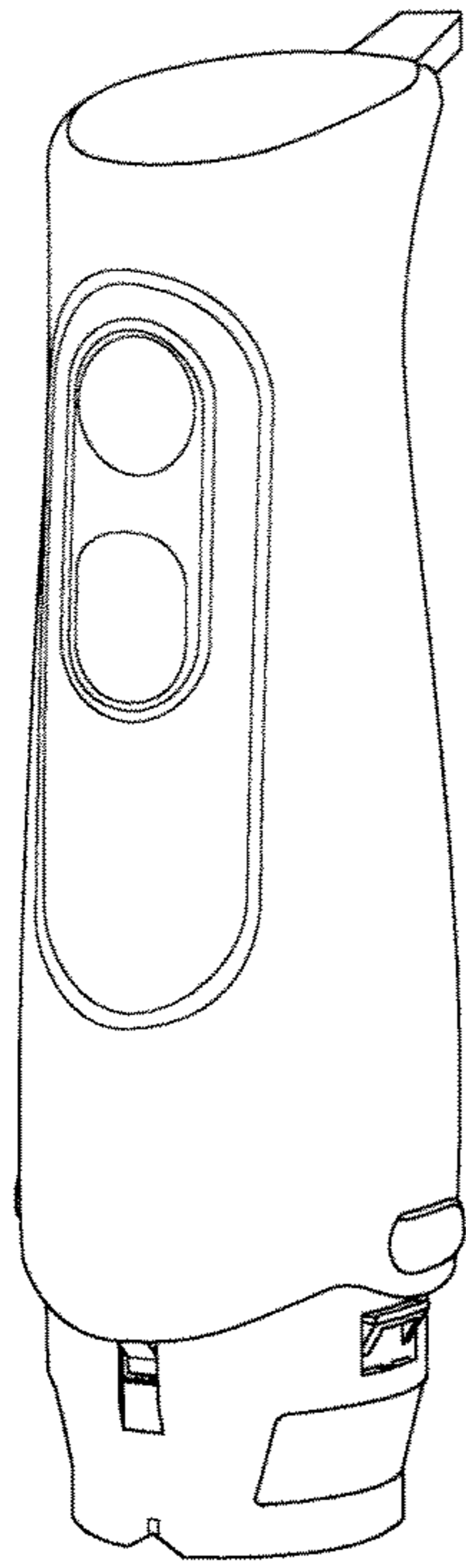

Fig. 8

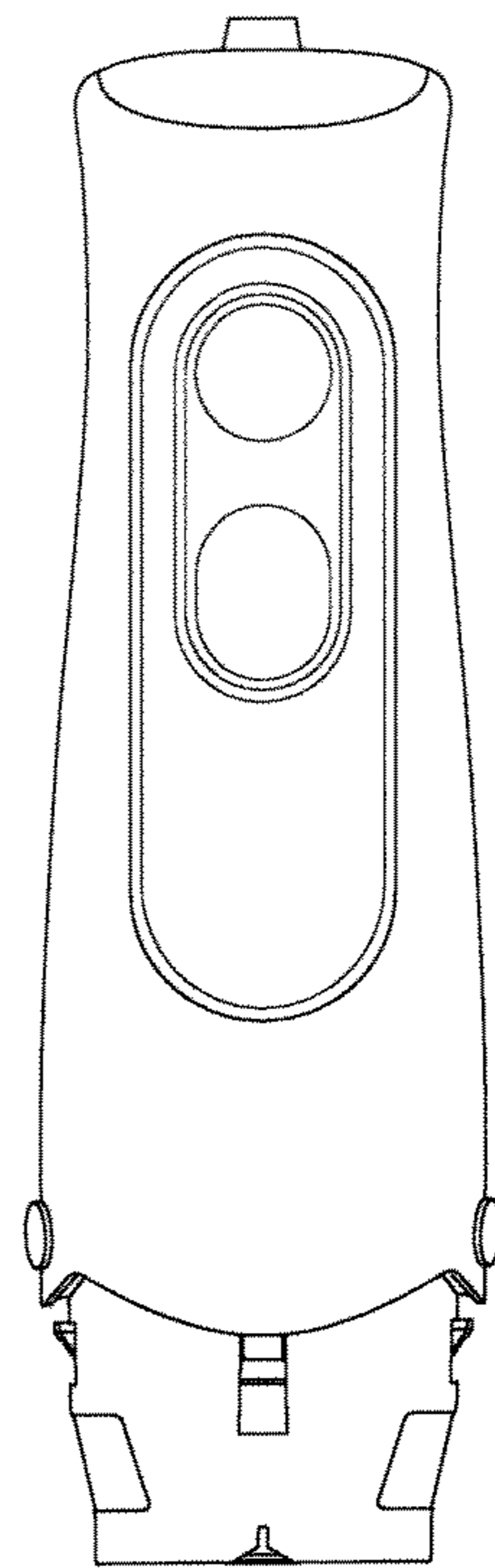

Fig. 9

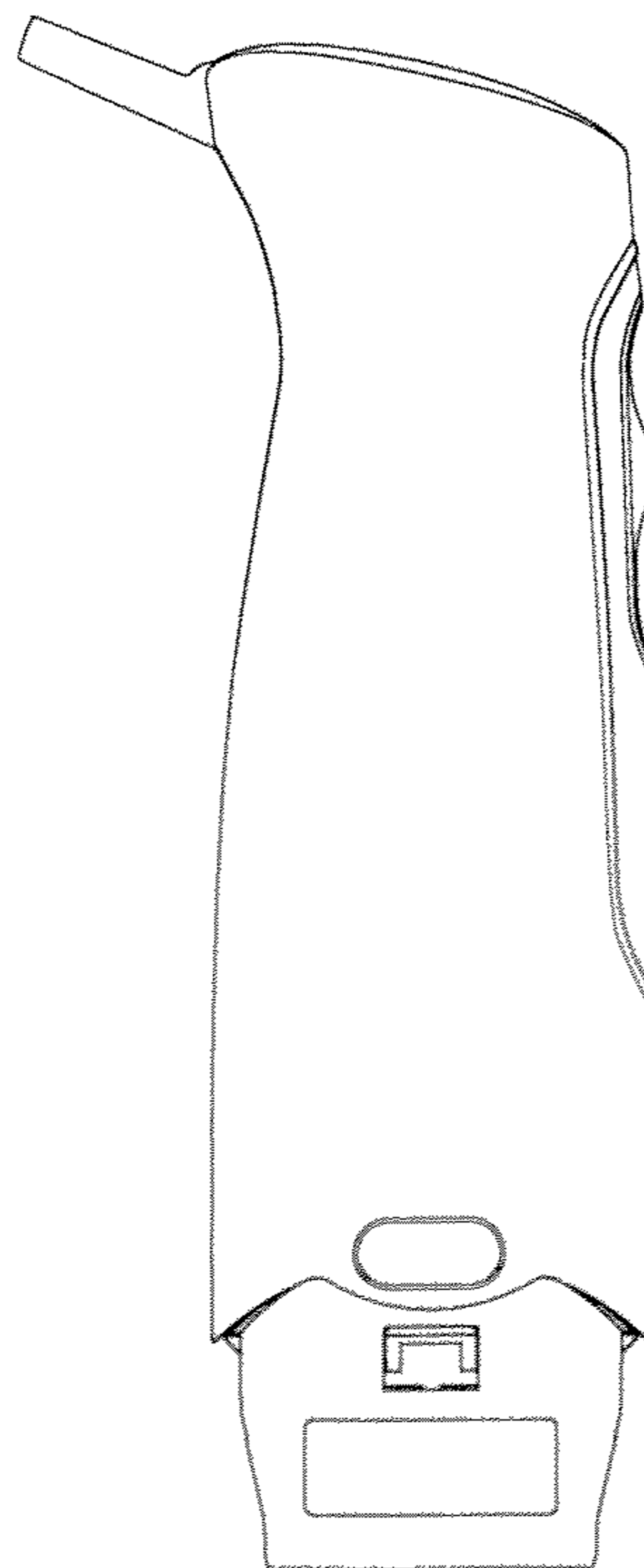

Fig. 10

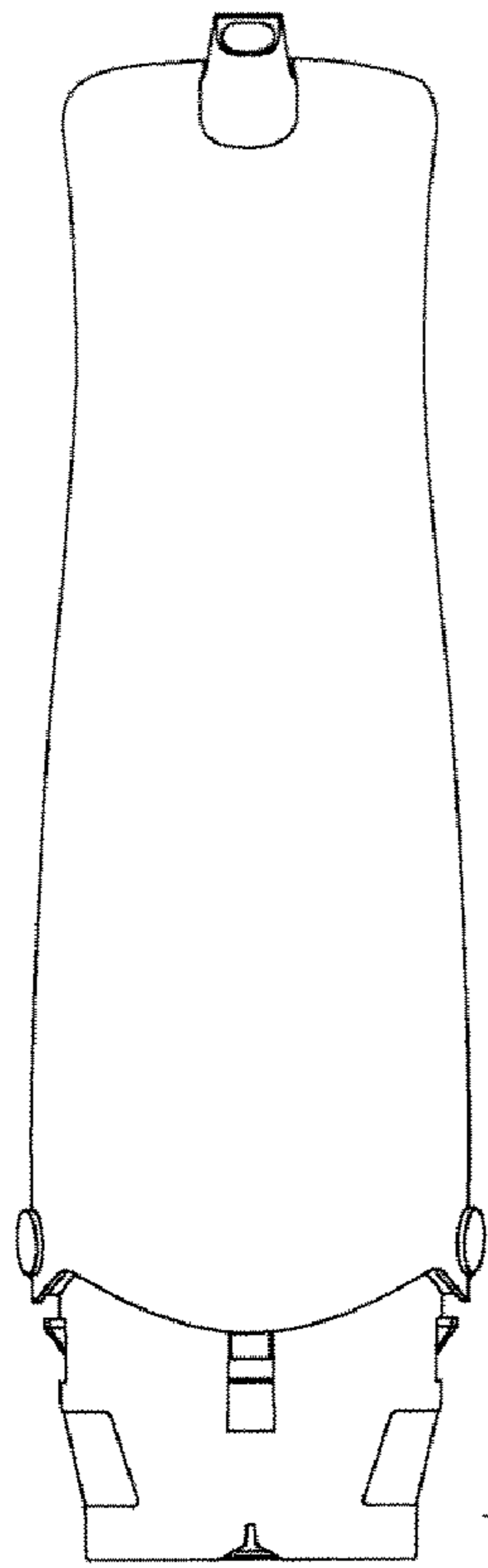

Fig. 11

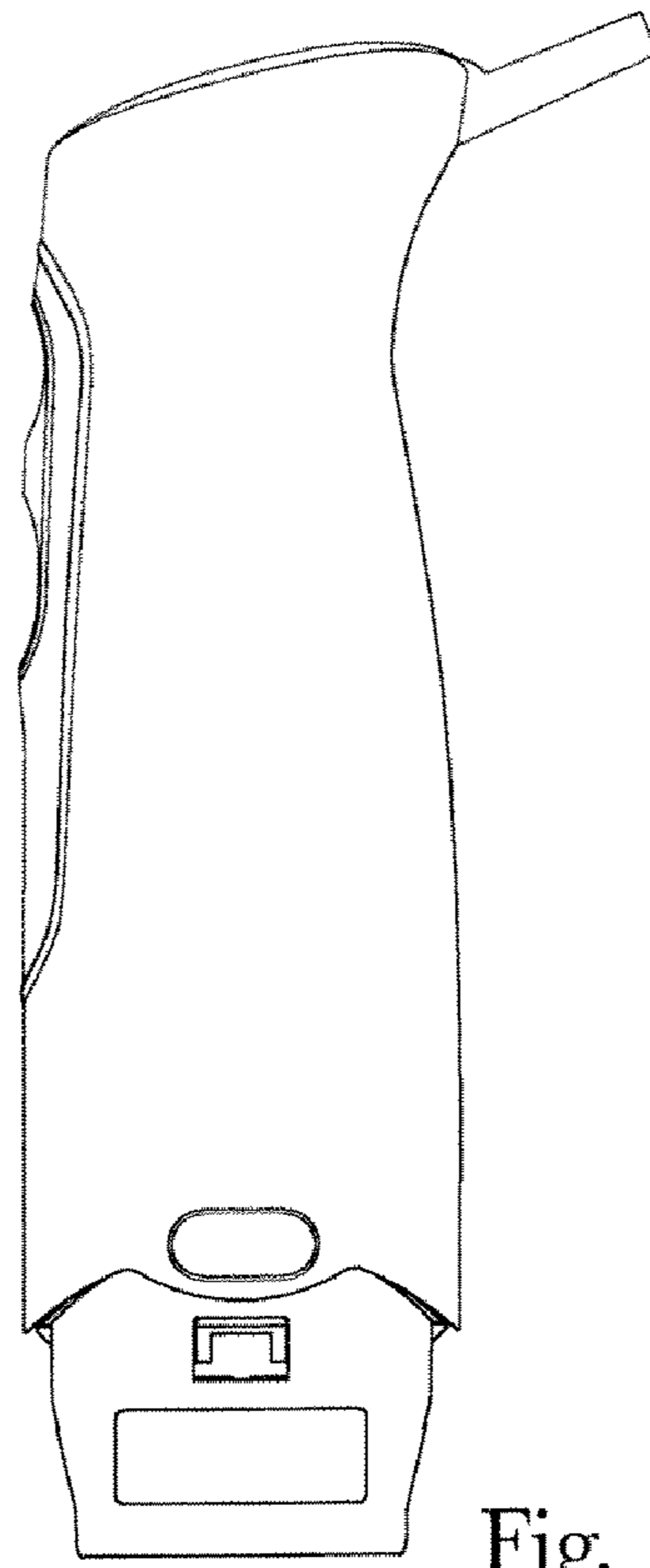

Fig. 12

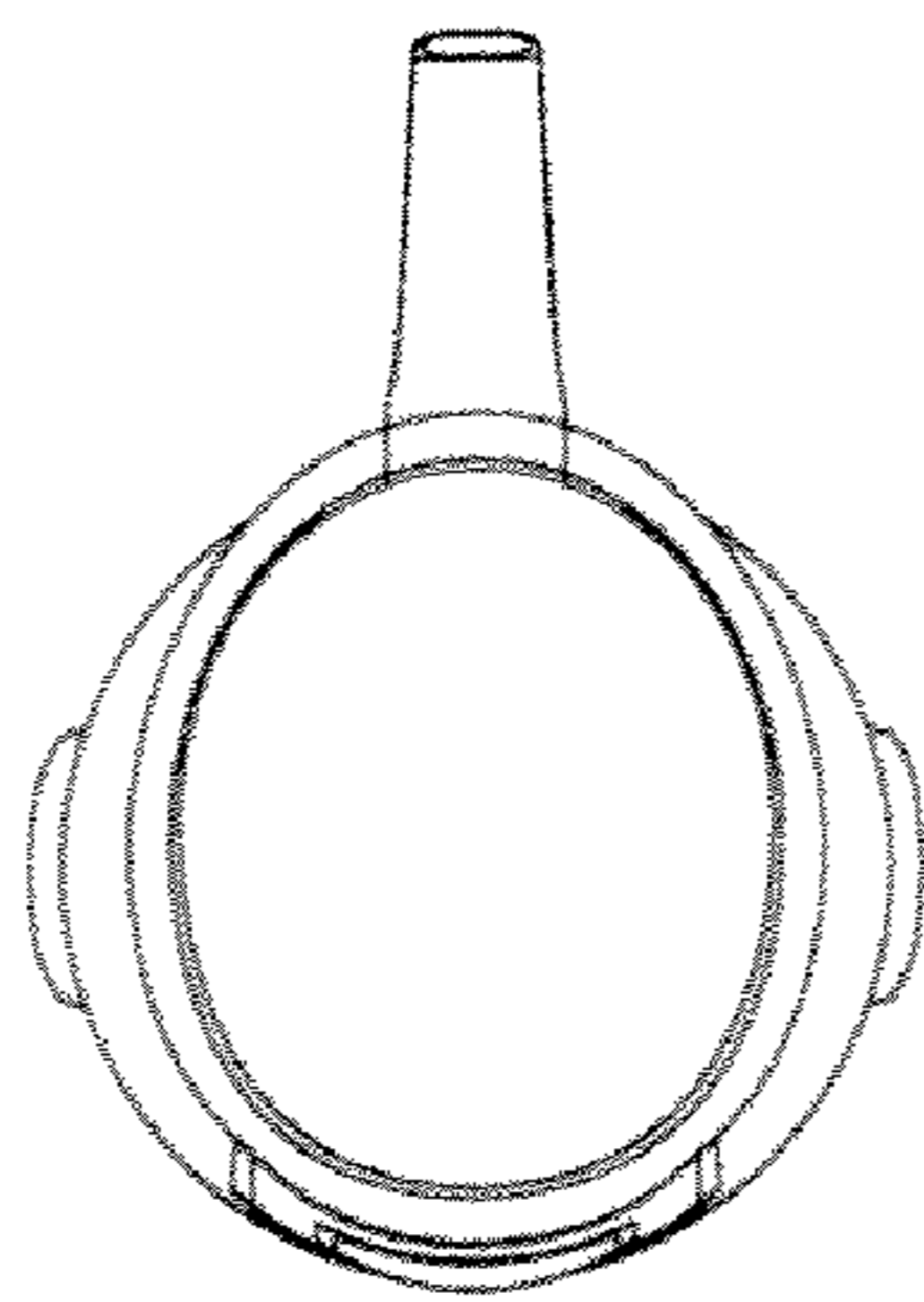

Fig. 13

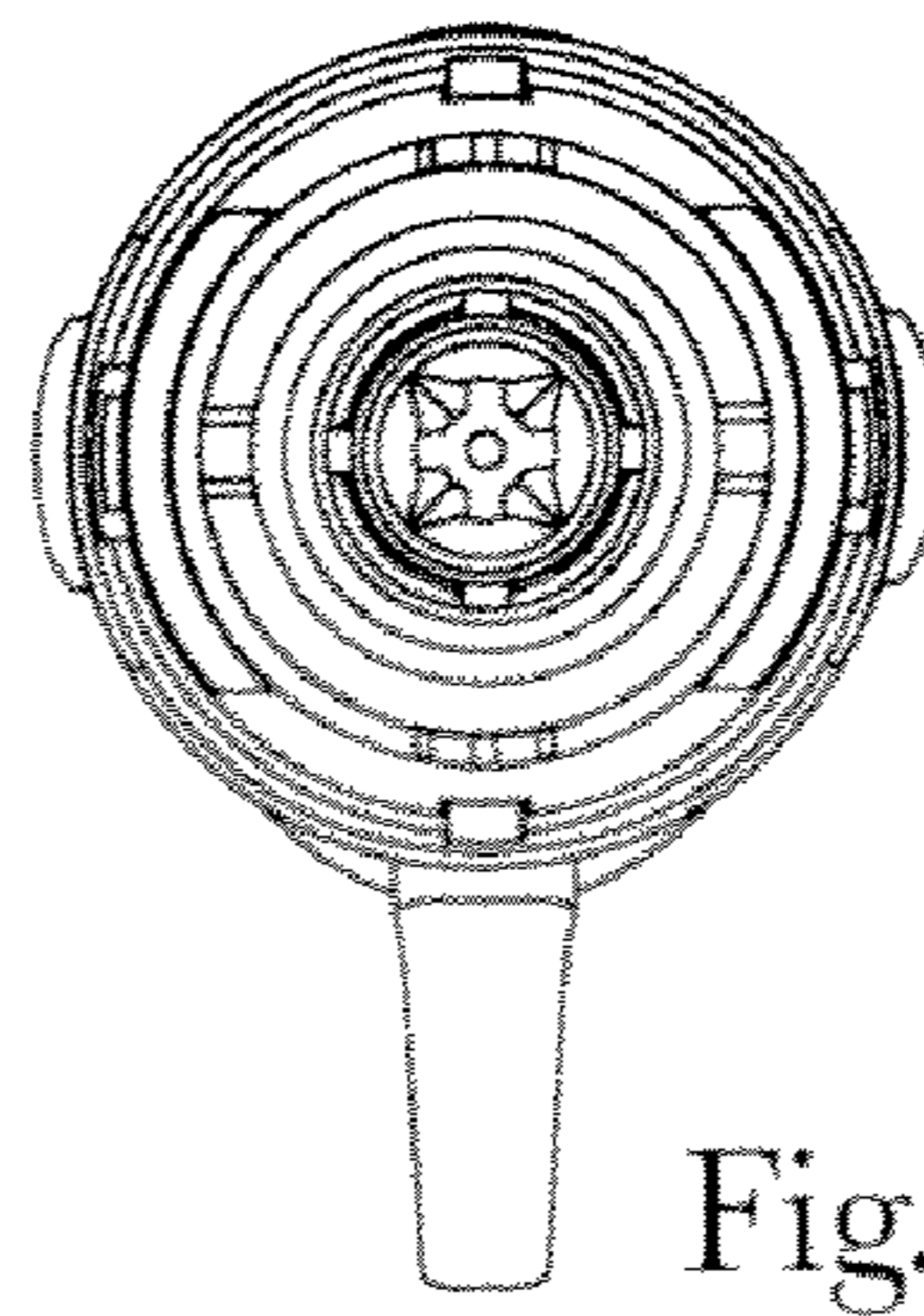

Fig. 14