



US00D649392S

(12) **United States Design Patent**
Cahen

(10) **Patent No.:** **US D649,392 S**

(45) **Date of Patent:** **** Nov. 29, 2011**

(54) **COFFEE MACHINE**

(75) Inventor: **Antoine Cahen**, Lausanne (CH)

(73) Assignee: **Societe des Produits Nestle S.A.**, Vevey (CH)

(**) Term: **14 Years**

(21) Appl. No.: **29/374,332**

(22) Filed: **Jul. 28, 2011**

Related U.S. Application Data

(62) Division of application No. 29/349,701, filed on Apr. 23, 2010, now Pat. No. Des. 644,058.

(30) **Foreign Application Priority Data**

Feb. 15, 2010 (CH) 136675

(51) **LOC (9) Cl.** **07-01**

(52) **U.S. Cl.** **D7/307; D7/311; D7/306**

(58) **Field of Classification Search** **D7/300, D7/306, 309-311; 99/282, 307, 312, 316**

See application file for complete search history.

(56) **References Cited**

U.S. PATENT DOCUMENTS

5,233,914	A	*	8/1993	English	99/282
D459,628	S	*	7/2002	Cahen	D7/309
D461,358	S	*	8/2002	Cahen	D7/309
D495,188	S	*	8/2004	Cahen	D7/309
D550,499	S	*	9/2007	Argabrite et al.	D7/309
D587,510	S	*	3/2009	Lam	D7/309
D596,441	S	*	7/2009	Cahen	D7/309
D596,442	S	*	7/2009	Cahen	D7/309
D602,302	S	*	10/2009	Cahen	D7/309
D602,303	S	*	10/2009	Cahen	D7/309

* cited by examiner

Primary Examiner — Marianne Pandozzi

(74) *Attorney, Agent, or Firm* — K&L Gates LLP

(57) **CLAIM**

The ornamental design for a coffee machine, as shown and described.

DESCRIPTION

FIG. 1 illustrates a right front perspective view of the coffee machine showing my new design;
FIG. 2 illustrates a front elevation view thereof;
FIG. 3 illustrates a rear elevation view thereof;
FIG. 4 illustrates a right side elevation view thereof;
FIG. 5 illustrates a left side elevation view thereof;
FIG. 6 illustrates a top view thereof; and,
FIG. 7 illustrates a bottom view thereof.

1 Claim, 6 Drawing Sheets

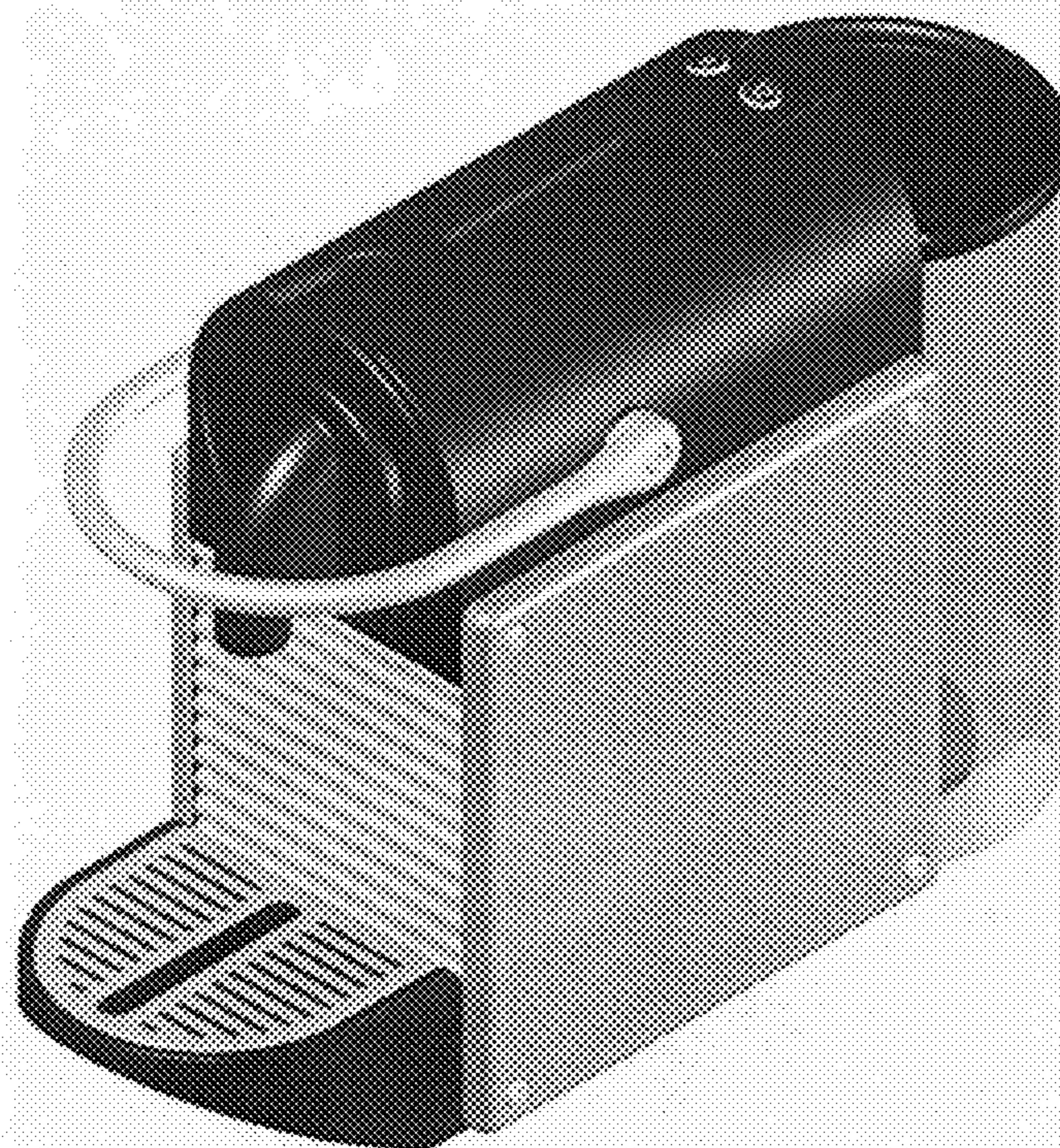

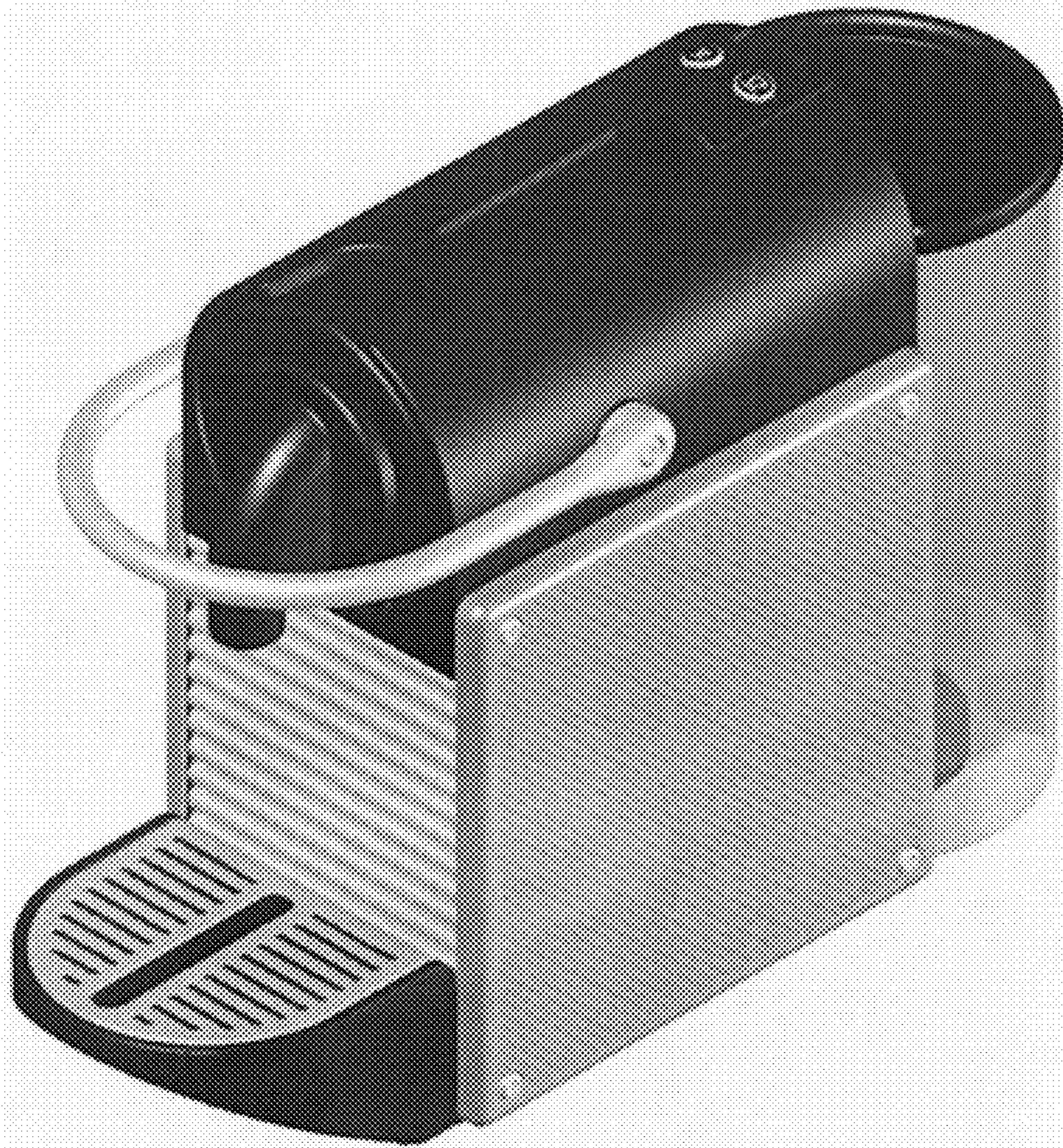

FIG. 1

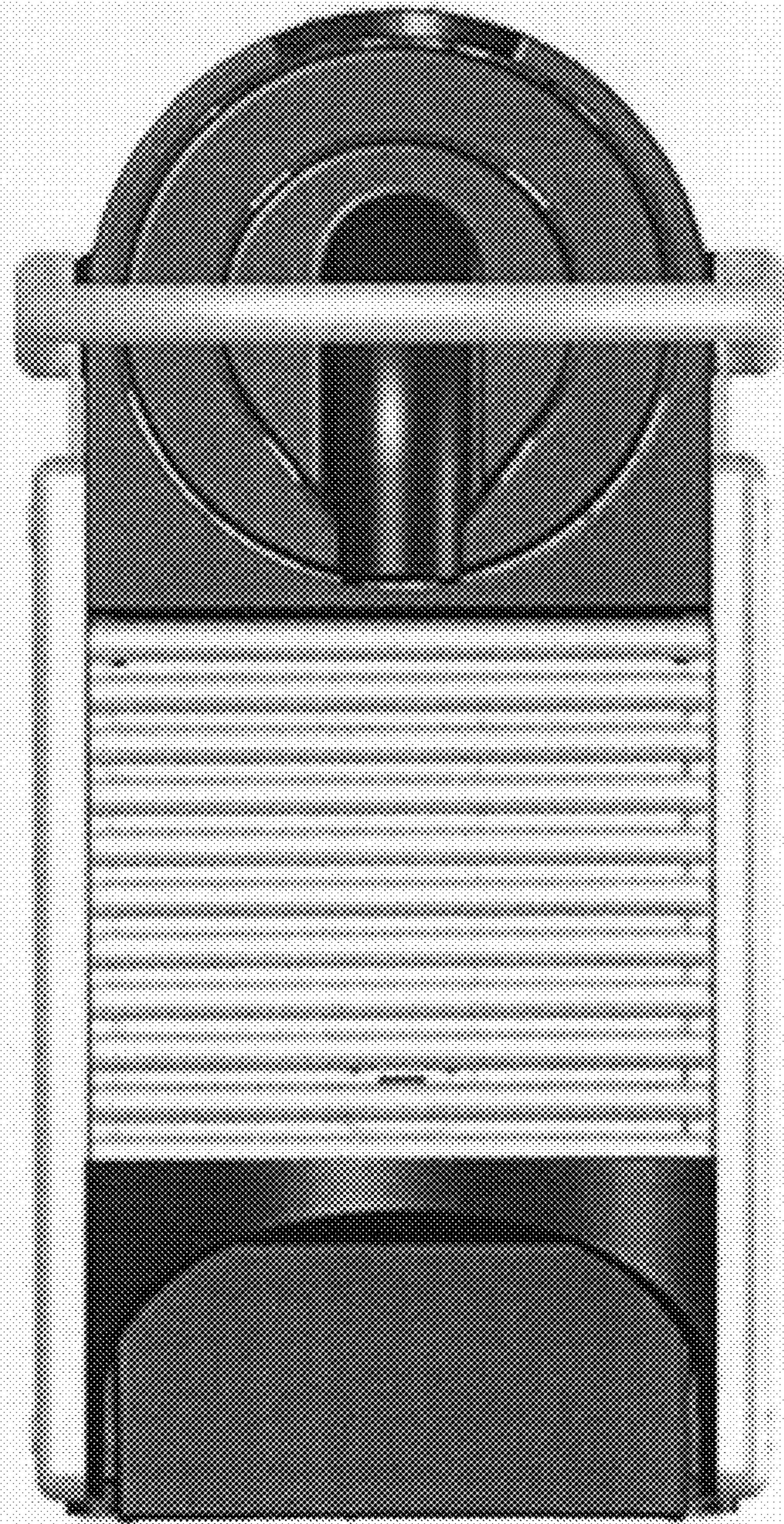

FIG. 2

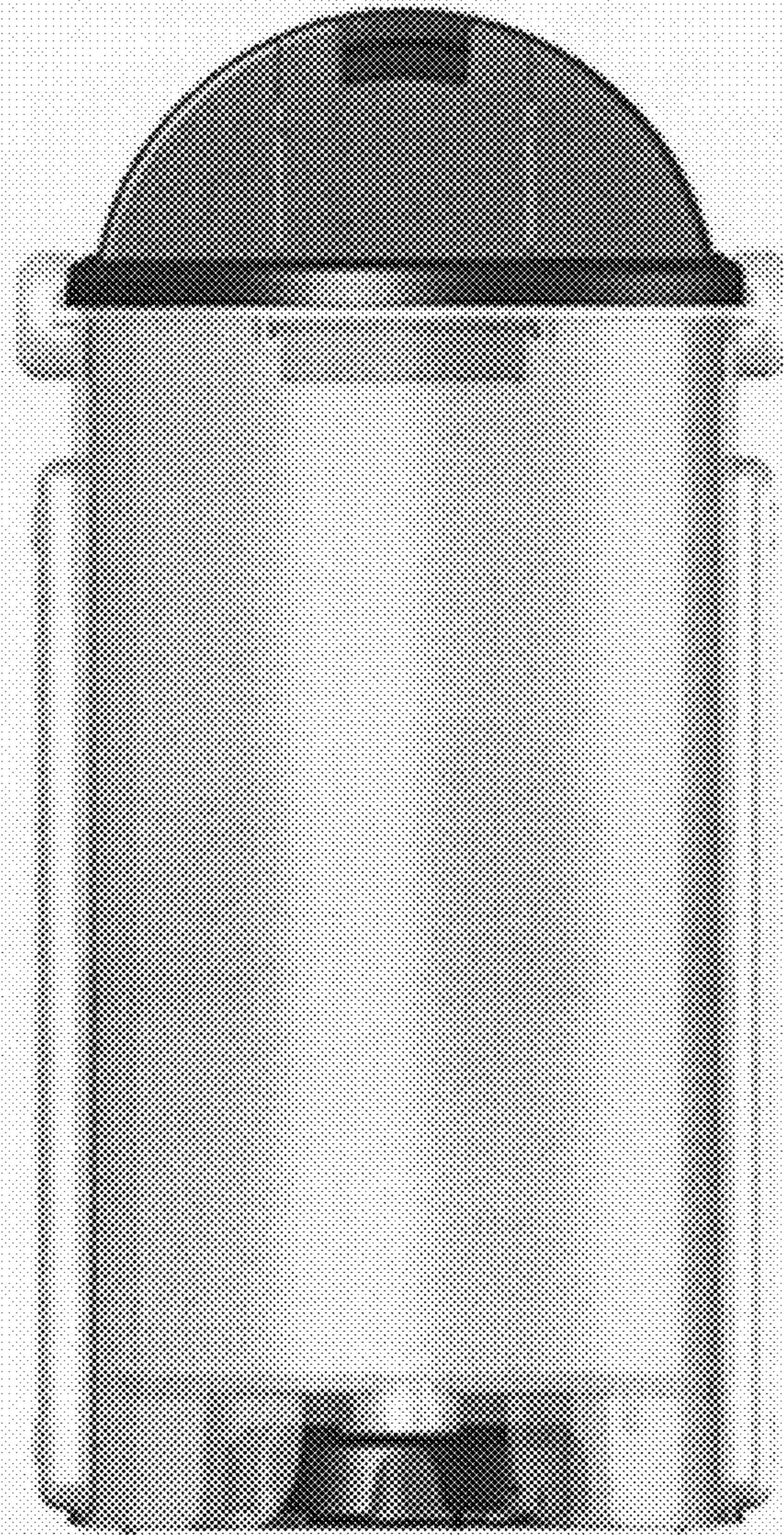

FIG. 3

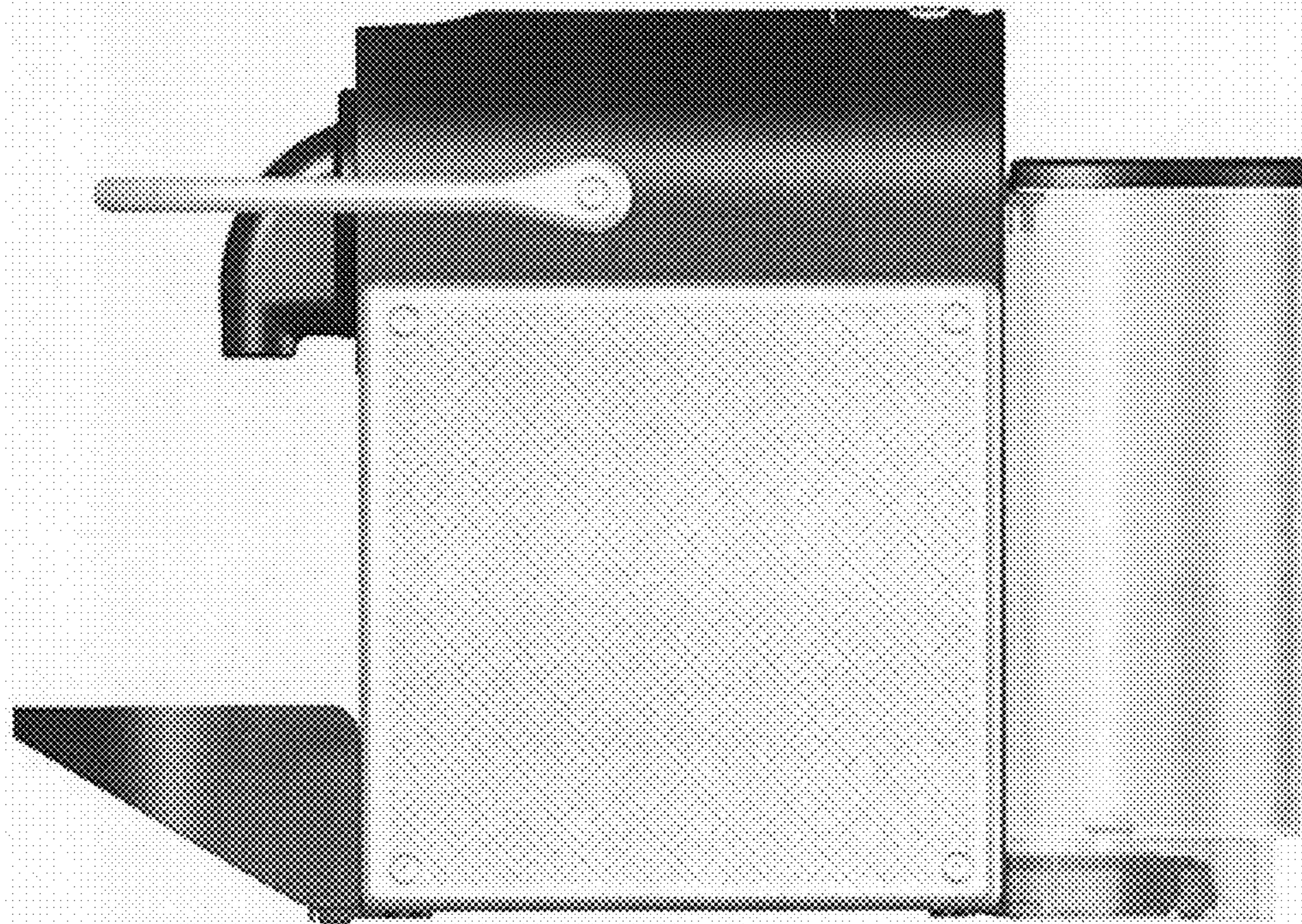

FIG. 4

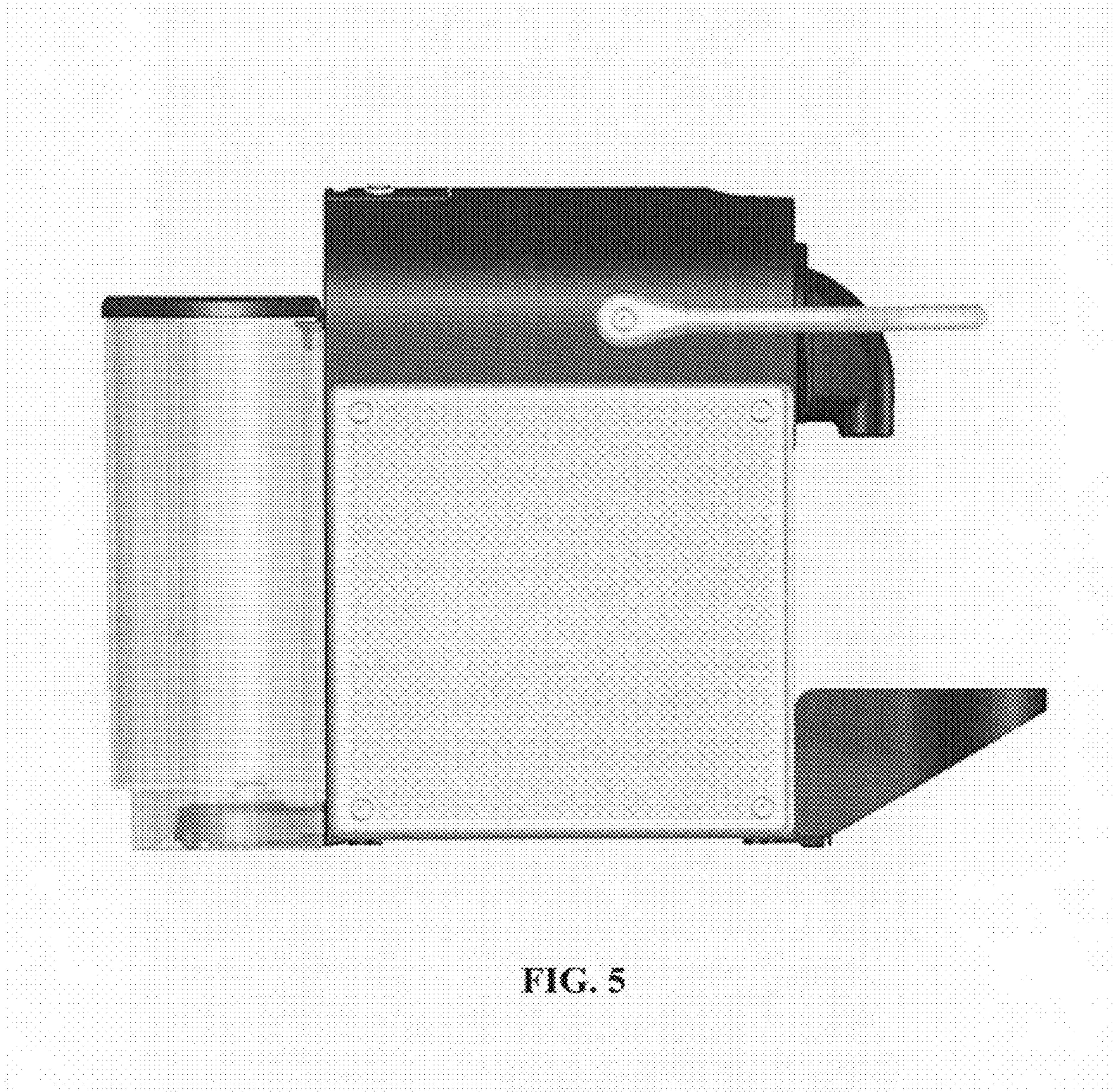

FIG. 5

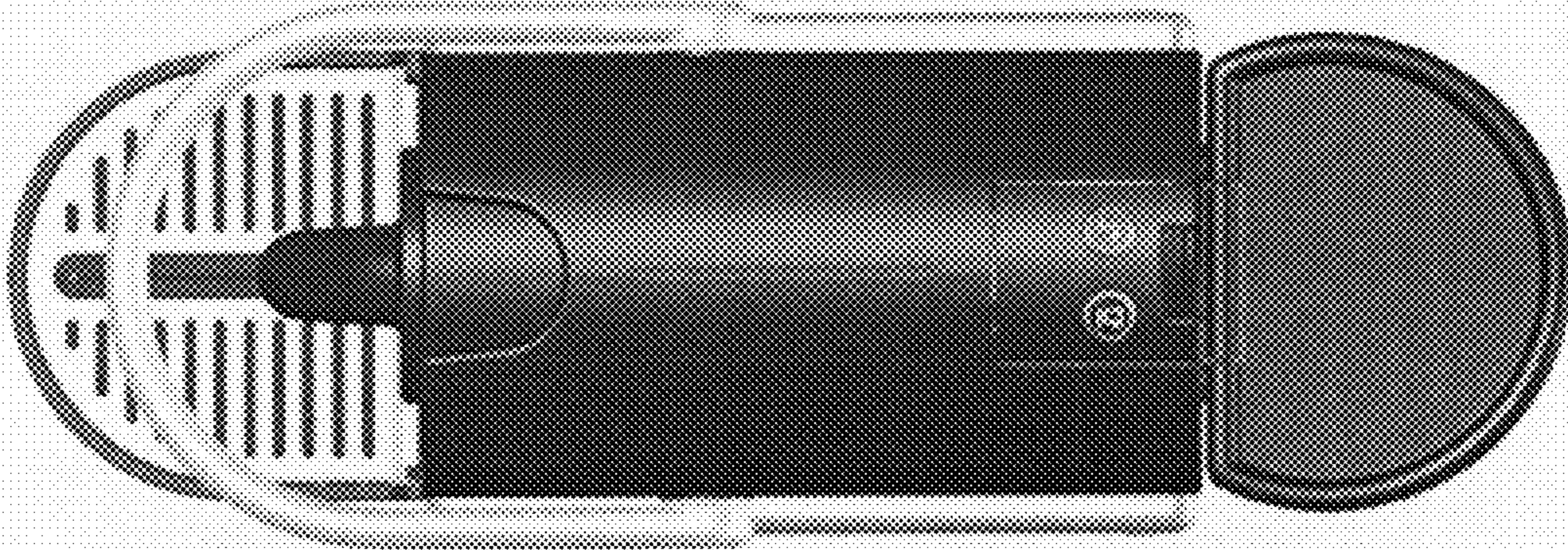

FIG. 6

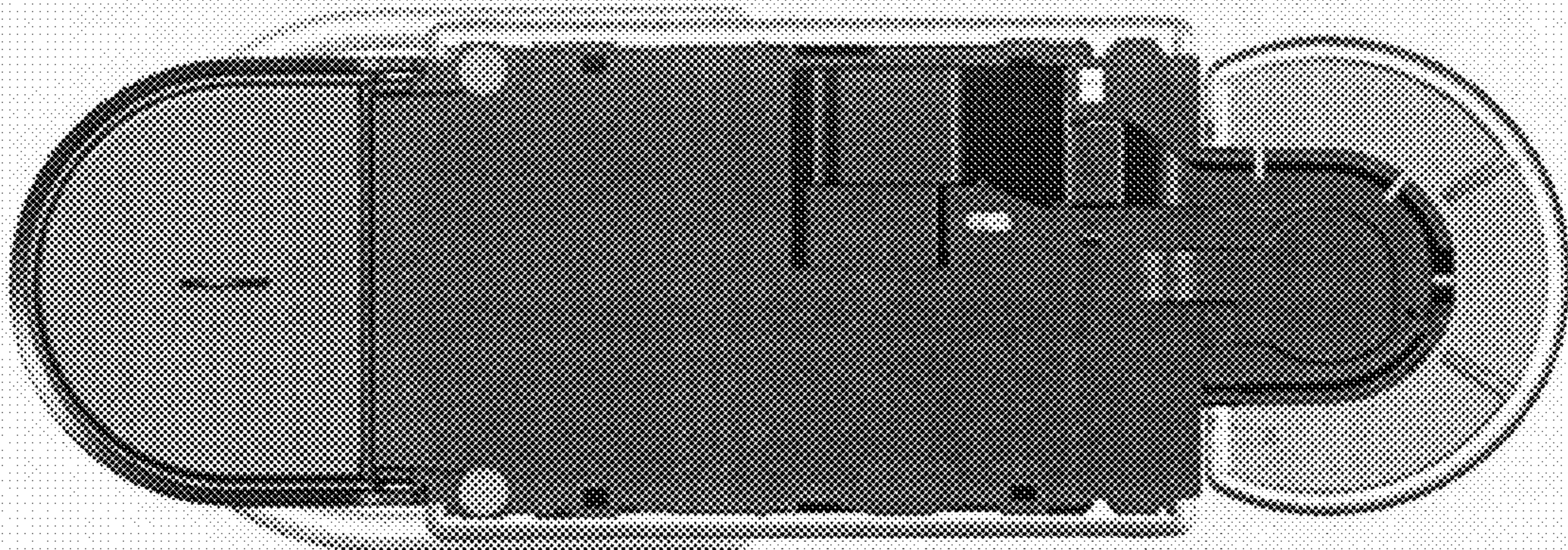

FIG. 7