



US00D649212S

(12) **United States Design Patent**  
**Geiger**

(10) **Patent No.:** **US D649,212 S**

(45) **Date of Patent:** **\*\* Nov. 22, 2011**

(54) **RECREATIONAL SNOW BOARD**

(76) **Inventor:** **Steve Geiger**, Wayland, MA (US)

(\*\*) **Term:** **14 Years**

(21) **Appl. No.:** **29/391,969**

(22) **Filed:** **May 16, 2011**

(51) **LOC (9) Cl.** ..... **21-02**

(52) **U.S. Cl.** ..... **D21/760; D21/766**

(58) **Field of Classification Search** ..... D21/760,  
D21/761, 765, 766, 801, 803; 441/65-66,  
441/68-69, 72-75, 79; D12/6; 280/11.3,  
280/11.31, 601-606, 609-610

See application file for complete search history.

(56) **References Cited**

**U.S. PATENT DOCUMENTS**

1,440,565	A *	1/1923	Solbjor	.....	280/601
2,819,907	A *	1/1958	Thoresen	.....	280/7.13
4,533,150	A *	8/1985	Hardy	.....	280/14.28
D308,711	S *	6/1990	Katz	.....	D21/766
D406,626	S *	3/1999	Hauser et al.	.....	D21/760
D408,067	S *	4/1999	McGarry	.....	D21/760
D418,545	S *	1/2000	Cassel	.....	D21/766
D471,006	S *	3/2003	French	.....	D3/221

D561,860	S *	2/2008	Carlson et al.	.....	D21/760
D567,712	S *	4/2008	Brazier	.....	D12/8
D630,697	S *	1/2011	Greenfield	.....	D21/760
2004/0070175	A1 *	4/2004	Jacobi	.....	280/606

\* cited by examiner

*Primary Examiner* — Zenia Bennett

(74) *Attorney, Agent, or Firm* — Bay State IP, LLC; Adam J. Bruno

(57) **CLAIM**

I claim the ornamental design for a recreational snow board, as shown and described.

**DESCRIPTION**

FIG. 1 is a front side perspective view showing my new design;

FIG. 2 is a bottom side perspective view thereof;

FIG. 3 is a front view thereof;

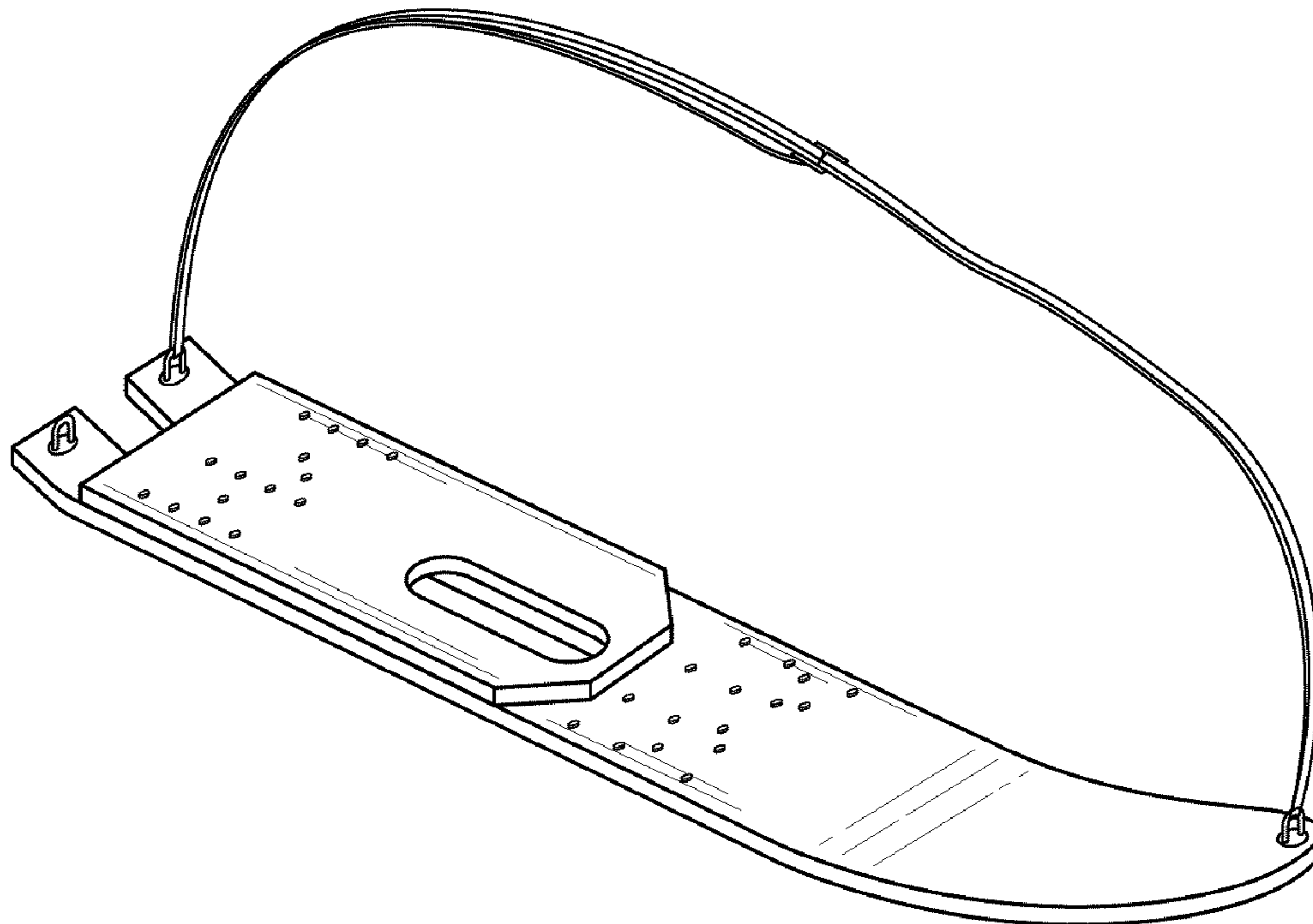
FIG. 4 is a back view thereof;

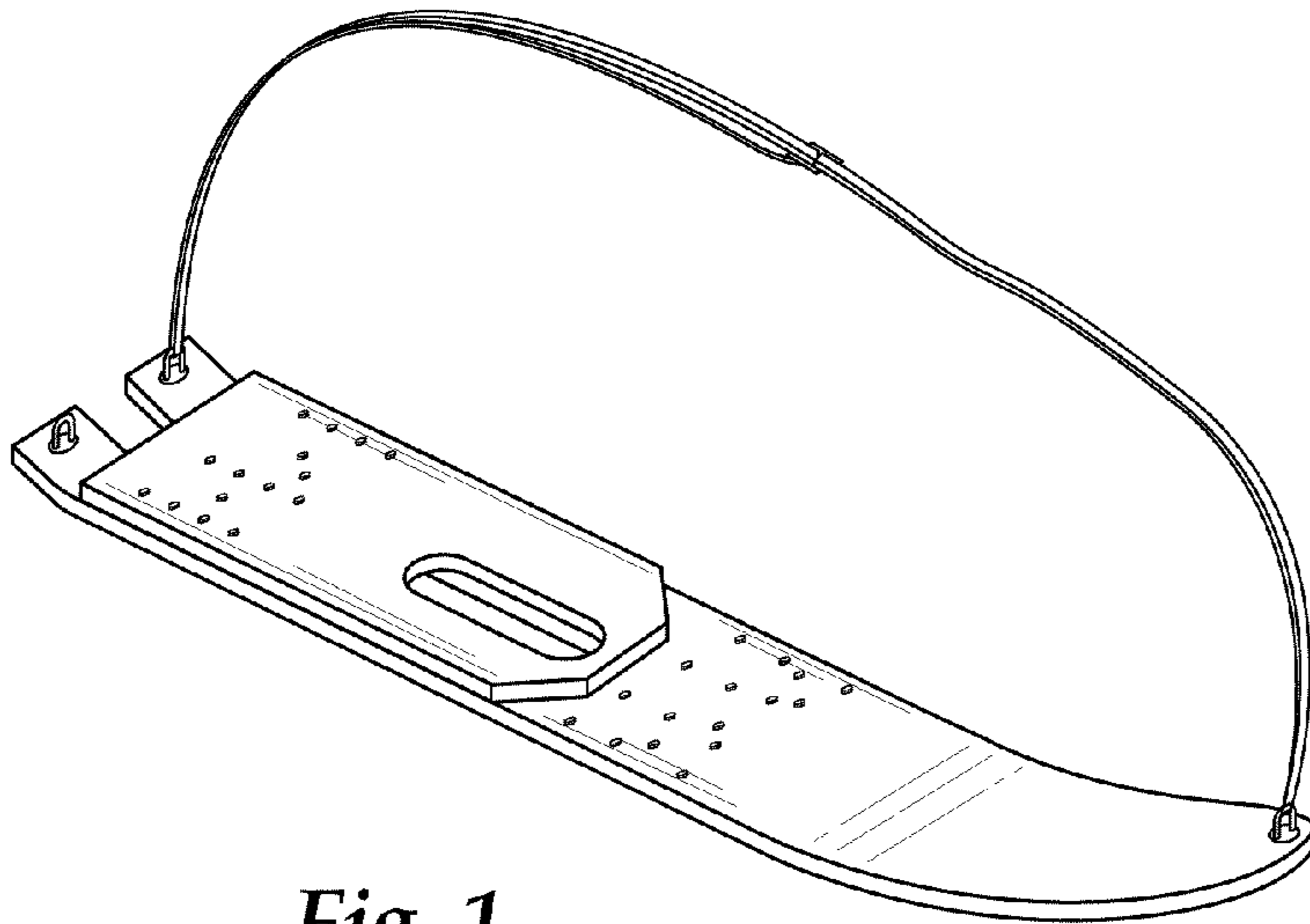
FIG. 5 is a top view thereof;

FIG. 6 is a bottom view thereof; and,

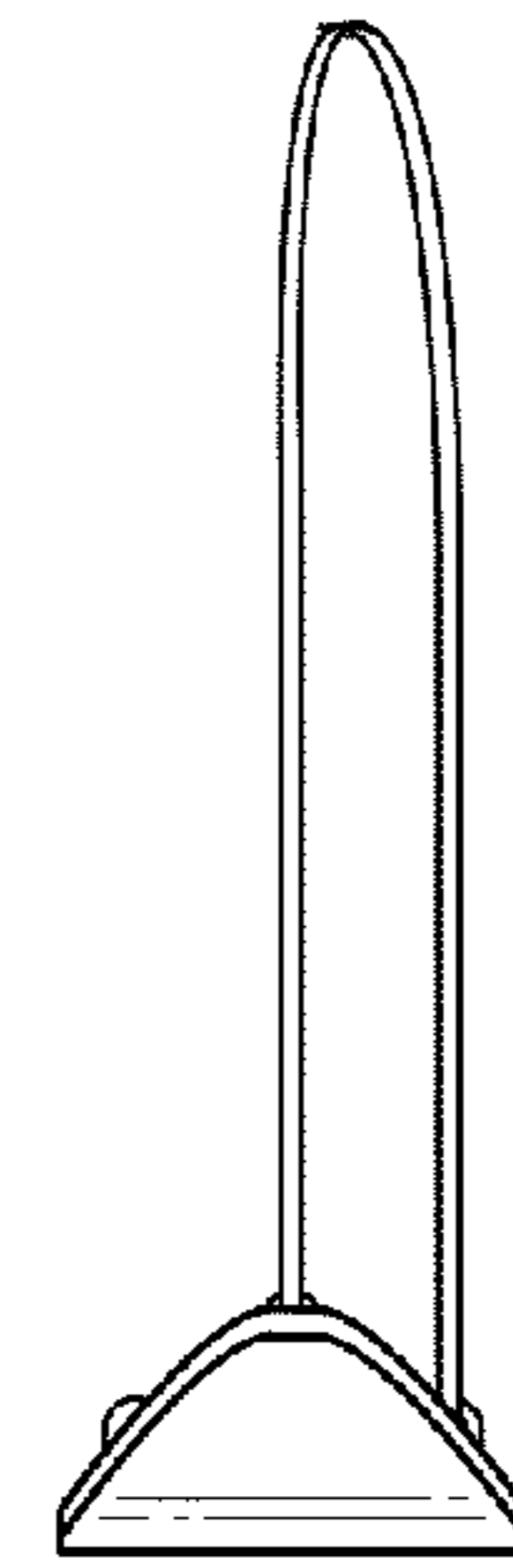
FIG. 7 is a side view thereof.

**1 Claim, 2 Drawing Sheets**

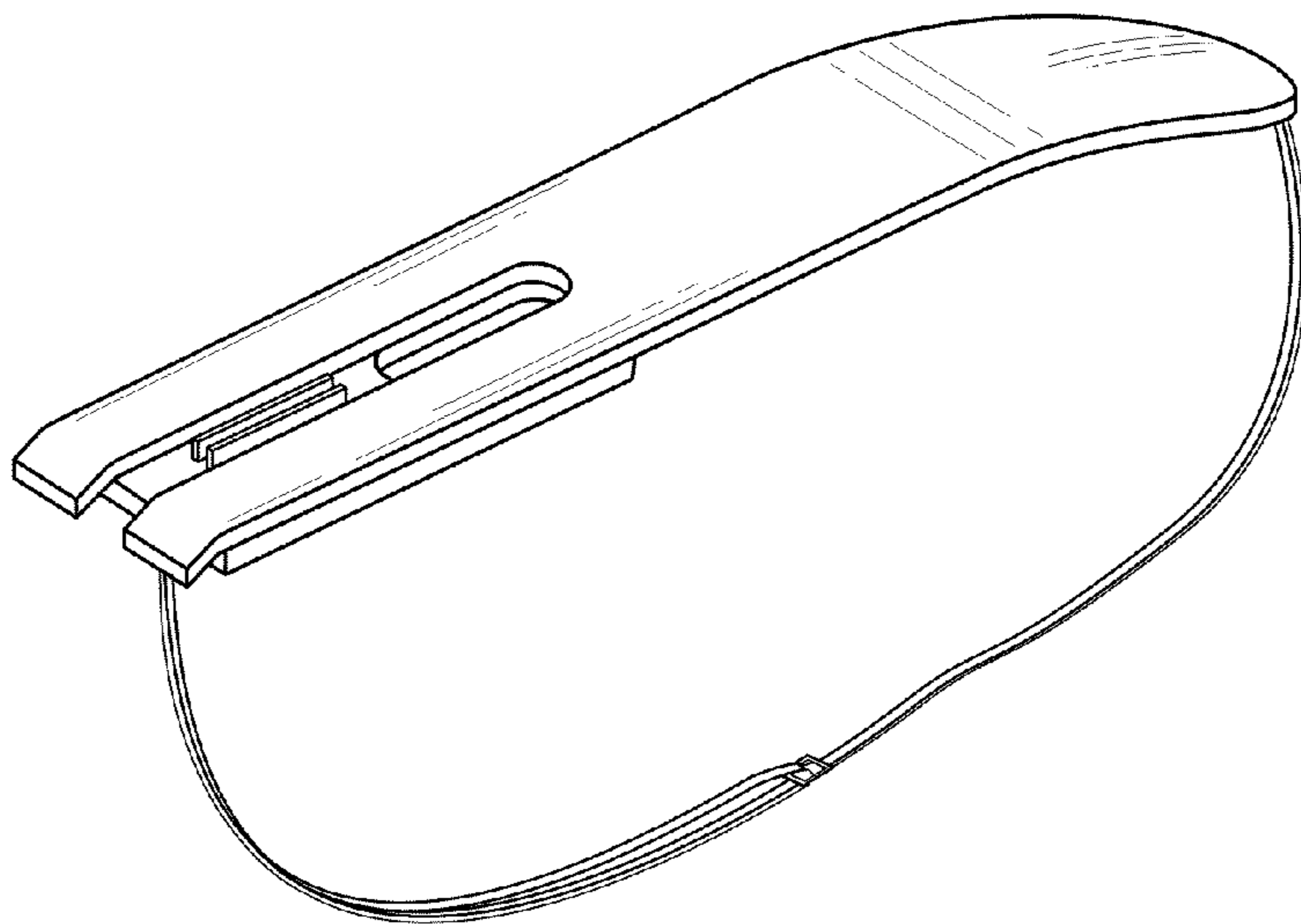




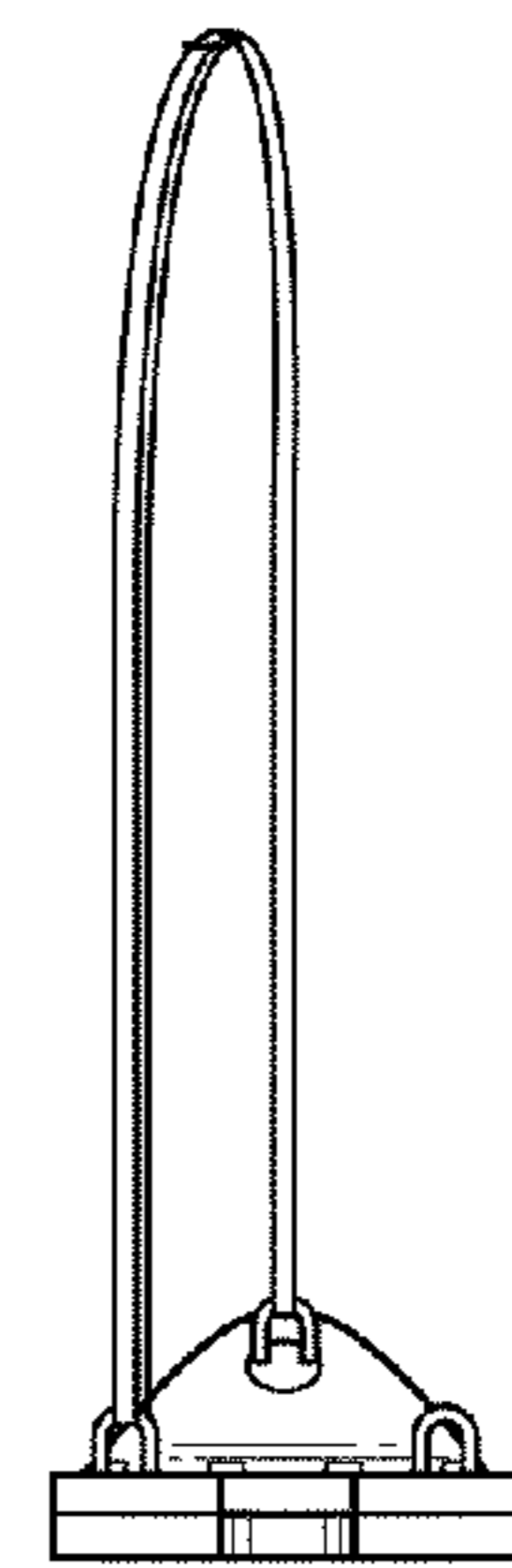
*Fig. 1*



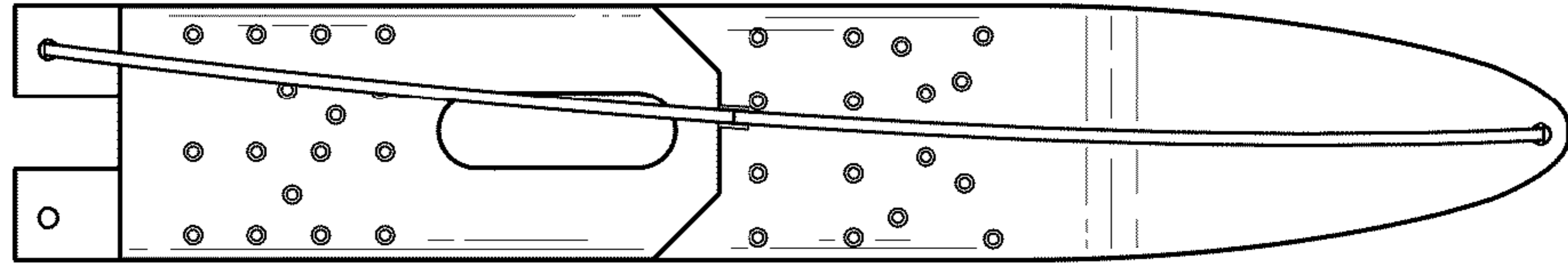
*Fig. 3*



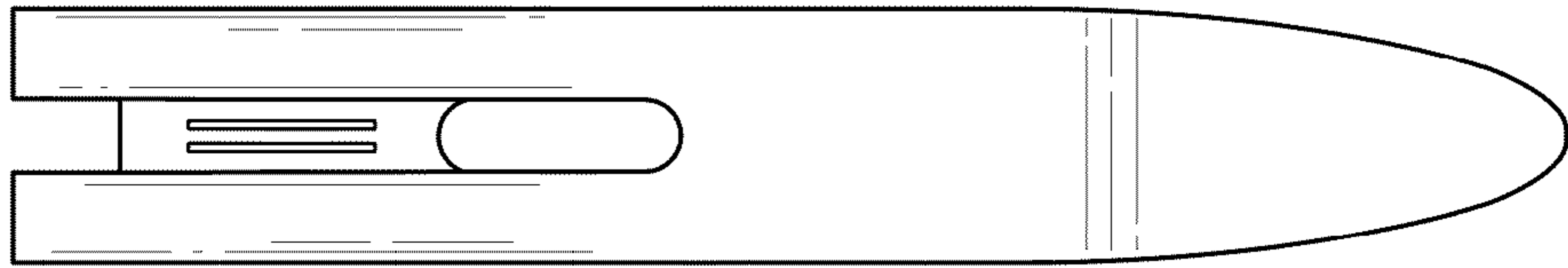
*Fig. 2*



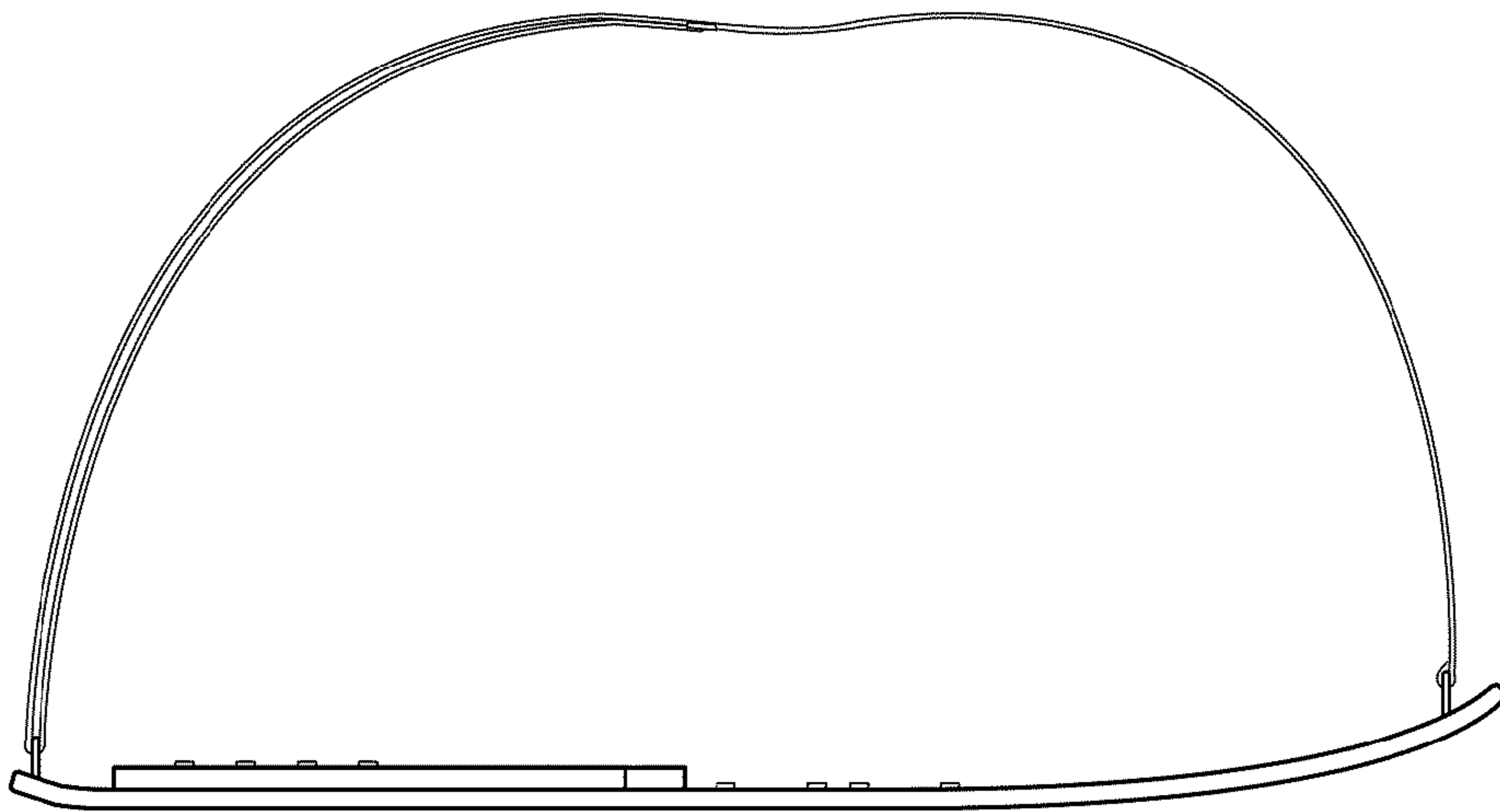
*Fig. 4*



*Fig. 5*



*Fig. 6*



*Fig. 7*