



US00D649189S

(12) **United States Design Patent**
Maier

(10) **Patent No.:** **US D649,189 S**

(45) **Date of Patent:** **** Nov. 22, 2011**

(54) **PEN**

(75) **Inventor:** **Lothar Maier**, Lachen (CH)

(73) **Assignee:** **Swarovski Aktiengesellschaft**, Triesen (LI)

(**) **Term:** **14 Years**

(21) **Appl. No.:** **29/383,023**

(22) **Filed:** **Jan. 11, 2011**

(30) **Foreign Application Priority Data**

Jul. 13, 2010 (EM) 001730599

(51) **LOC (9) Cl.** **19-06**

(52) **U.S. Cl.** **D19/47**

(58) **Field of Classification Search** D19/35,
D19/36, 41-51, 54-58; 24/11 R, 11 F, 11 P;
401/52, 99, 100, 192, 195, 196; D14/411
See application file for complete search history.

(56) **References Cited**

U.S. PATENT DOCUMENTS

D153,679 S *	5/1949	Gruber	D19/51
D191,729 S *	11/1961	Lovejoy	D19/48
D191,998 S *	12/1961	Doman	D19/49
D258,069 S *	1/1981	Malamoud	D19/48
D267,887 S *	2/1983	Rigoni	D19/49
D274,917 S *	7/1984	Hechter	D19/51
D280,420 S *	9/1985	Verhaegue	D19/48
D312,837 S *	12/1990	Oka	D19/51
D323,852 S *	2/1992	Gomez	D19/48
D359,982 S *	7/1995	Rosenbaum	D19/49
D367,673 S *	3/1996	Compte	D19/51
D371,576 S *	7/1996	Compte	D19/49
D394,087 S *	5/1998	Boix Gacia	D19/51
D395,917 S *	7/1998	Rosenbaum	D19/49

D395,919 S *	7/1998	Rosenbaum	D19/51
D398,024 S *	9/1998	Frank	D19/42
D408,448 S *	4/1999	Rebien	D19/51
D415,197 S *	10/1999	Izushima	D19/48
6,019,536 A *	2/2000	Lee	401/195
6,174,098 B1 *	1/2001	Yeh	401/52
D467,614 S *	12/2002	Pellissa Beneyto	D19/51
D469,123 S *	1/2003	Briggl et al.	D19/48
D497,179 S *	10/2004	Chen	D19/36
6,910,824 B2 *	6/2005	Holland et al.	401/192
6,948,872 B2 *	9/2005	Eisele	401/52
7,121,752 B2 *	10/2006	Su	401/195
D543,890 S *	6/2007	Shah	D11/90
D569,296 S *	5/2008	Voorn	D11/90
D594,060 S *	6/2009	Uchida et al.	D19/49
D598,954 S *	8/2009	Wang et al.	D19/49
D606,587 S *	12/2009	Zhang	D19/49
D616,936 S *	6/2010	Liu	D19/49
D619,487 S *	7/2010	Graff	D11/3
D627,392 S *	11/2010	Graff	D19/47
D638,062 S *	5/2011	Wang	D19/49
D641,403 S *	7/2011	Parmigiani	D19/47

* cited by examiner

Primary Examiner — Elizabeth Albert

(74) *Attorney, Agent, or Firm* — Wenderoth, Lind & Ponack, L.L.P.

(57) **CLAIM**

The ornamental design for a pen, as shown and described.

DESCRIPTION

FIG. 1 is a front view of the invention;
FIG. 2 is a right side view of the invention;
FIG. 3 is a rear view of the invention;
FIG. 4 is a left side view of the invention;
FIG. 5 is a perspective view of the invention;
FIG. 6 is a bottom view of the invention; and,
FIG. 7 is a top view of the invention.

1 Claim, 3 Drawing Sheets

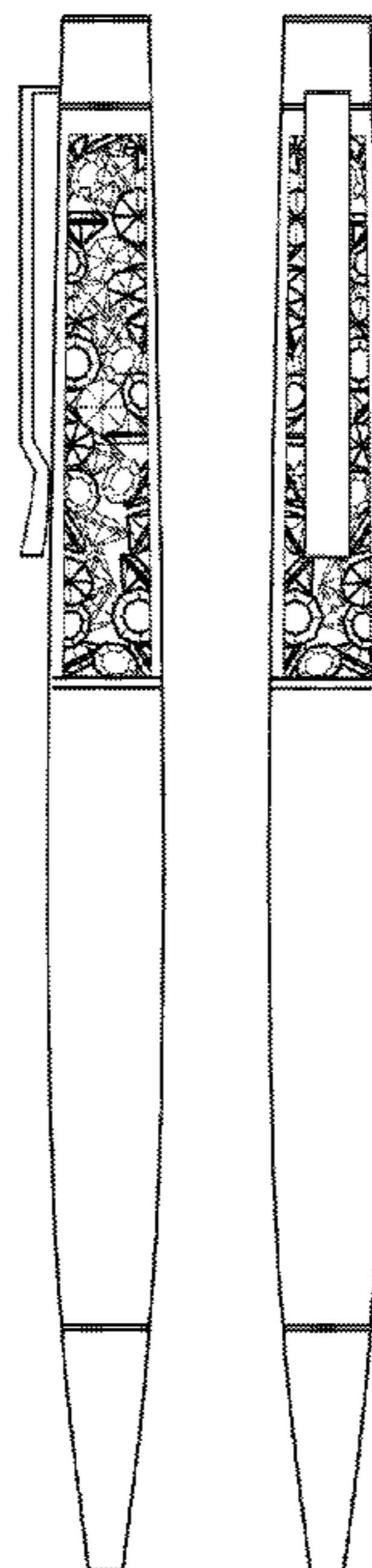

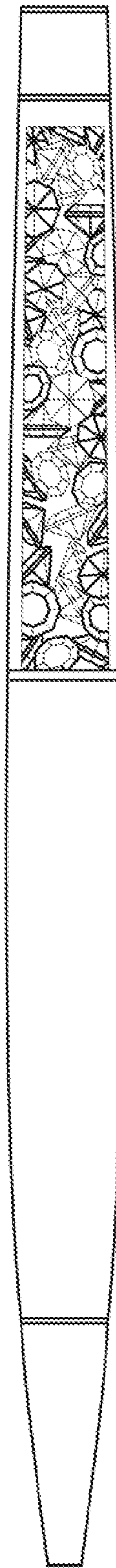

Fig. 1

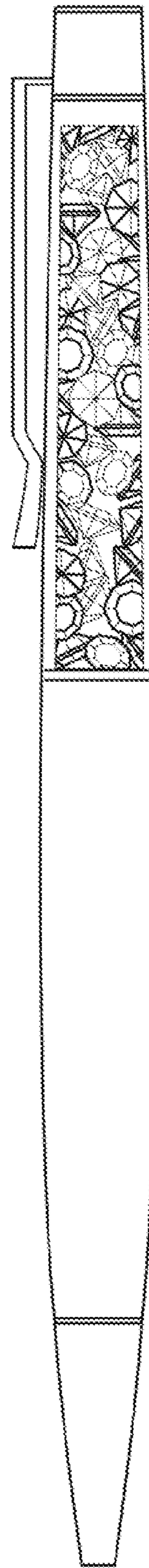

Fig. 2

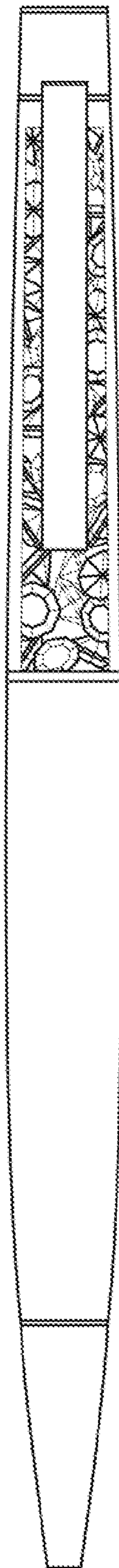

Fig. 3

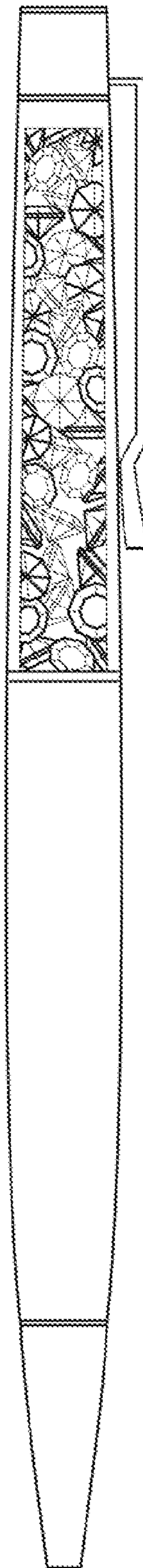

Fig. 4

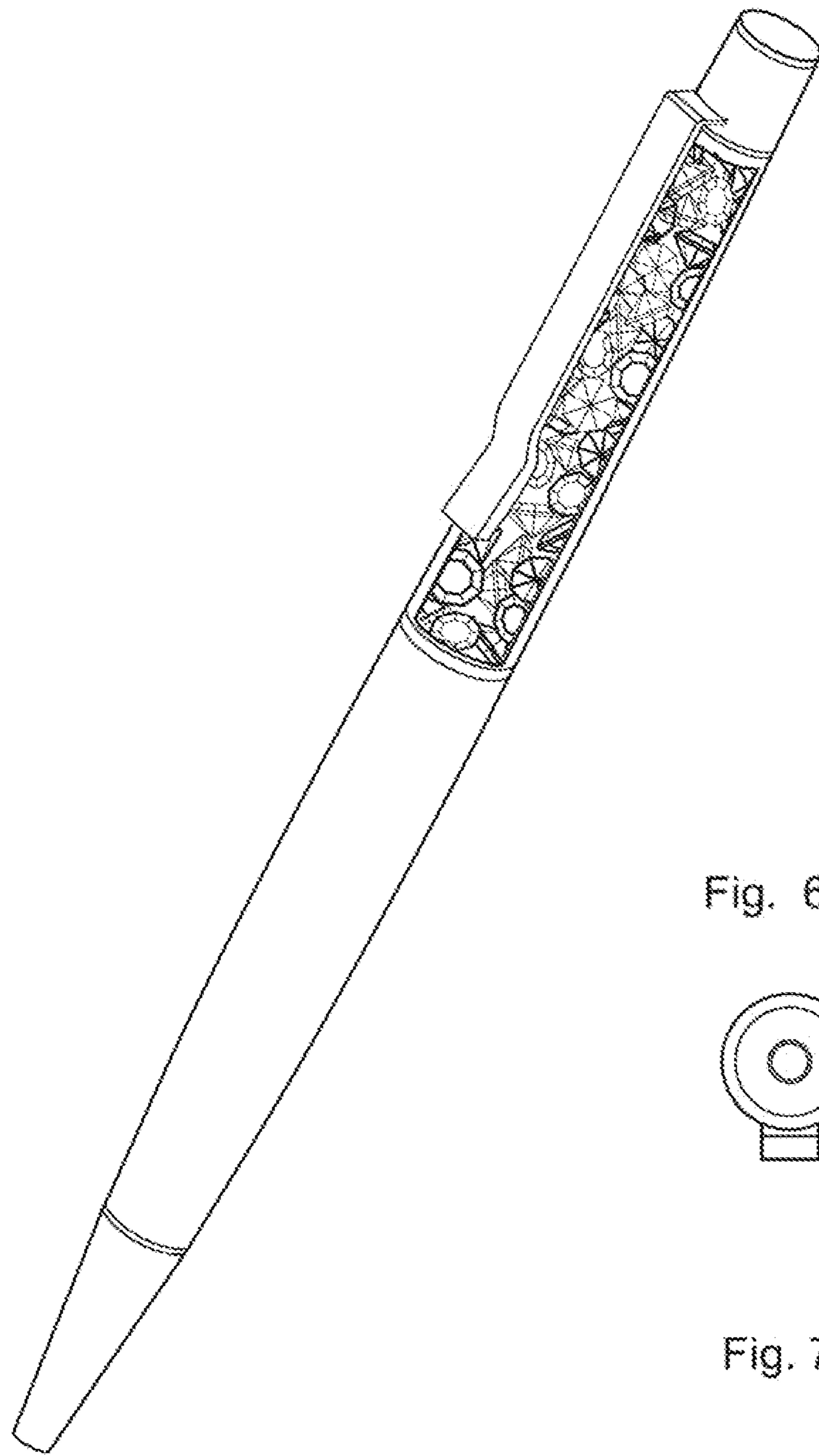

Fig. 5

Fig. 6

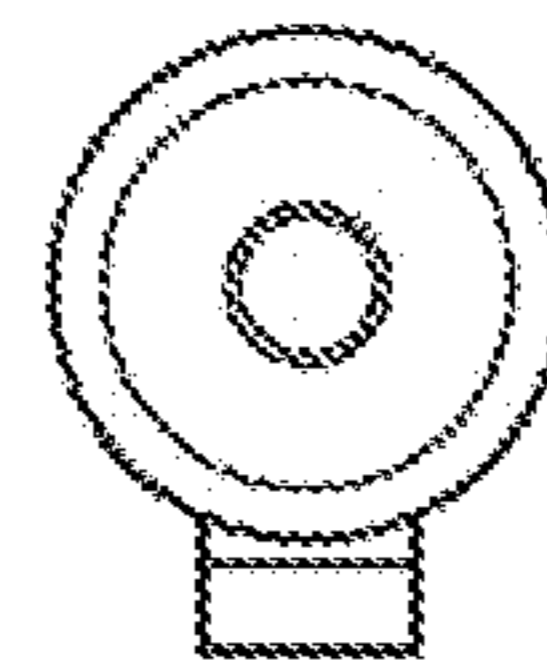

Fig. 7

