

US00D649130S

(12) **United States Design Patent**
Ge et al.

(10) **Patent No.:** **US D649,130 S**

(45) **Date of Patent:** **** Nov. 22, 2011**

(54) **MOBILE PHONE**

(75) Inventors: **Xiaofei Ge**, Shenzhen (CN); **Feng Xu**,
Shenzhen (CN)

(73) Assignee: **Huawei Device Co., Ltd.**, Shenzhen
(CN)

(**) Term: **14 Years**

(21) Appl. No.: **29/364,489**

(22) Filed: **Jun. 24, 2010**

(30) **Foreign Application Priority Data**

Dec. 25, 2009 (CN) 2009 3 0289687

(51) **LOC (9) Cl.** **14-03**

(52) **U.S. Cl.** **D14/138 AA**

(58) **Field of Classification Search** D14/138 AA,
D14/138 AB, 138 R, 138 AD, 138 AC, 138 G,
D14/341, 345, 346, 203.4, 203.7, 203.1, 203.3,
D14/496; 455/575.3, 575.1, 575.4, 556.2;
379/433.01, 433.04, 433.1, 433.13; D21/517

See application file for complete search history.

(56) **References Cited**

U.S. PATENT DOCUMENTS

D514,538 S *	2/2006	Chan et al.	D14/138 AA
D524,786 S *	7/2006	Paradise et al.	D14/138 AA
D543,191 S *	5/2007	Kim et al.	D14/138 AA
D546,316 S *	7/2007	Wu et al.	D14/138 AA
D560,645 S *	1/2008	Park	D14/138 AA
D562,314 S *	2/2008	Han et al.	D14/248
D576,993 S *	9/2008	Park et al.	D14/138 AA
D583,352 S *	12/2008	Son et al.	D14/138 AA
D585,039 S *	1/2009	Wang et al.	D14/138 AA
D601,530 S *	10/2009	Park et al.	D14/138 AA
D601,531 S *	10/2009	Lee et al.	D14/138 AA
D609,209 S *	2/2010	Cheng	D14/138 AA
D609,663 S *	2/2010	Kao et al.	D14/138 AA
D610,118 S *	2/2010	Boucquey et al.	D14/138 AA
D610,565 S *	2/2010	Lee et al.	D14/138 AA
D611,017 S *	3/2010	Loh et al.	D14/138 AA
D613,706 S *	4/2010	He	D14/138 AA
D614,599 S *	4/2010	Kim et al.	D14/138 AA

D617,292 S *	6/2010	Chen et al.	D14/138 AA
D617,299 S *	6/2010	Tzeng et al.	D14/138 AA
D617,300 S *	6/2010	Tzeng et al.	D14/138 AA
D619,982 S *	7/2010	Kim et al.	D14/138 AA
D620,466 S *	7/2010	Kim et al.	D14/138 AA
D622,686 S *	8/2010	Muspratt-Williams et al.	D14/138 AA
D626,929 S *	11/2010	Ge	D14/138 AB
D628,178 S *	11/2010	Cai	D14/138 AA

OTHER PUBLICATIONS

Huawei U1250 telephone, announced Feb. 2009, [online], [site visited Dec. 12, 2010]. Available from Internet, <URL: <http://www.gsmarena.com>>.*

Samsung J150 telephone, announced Feb. 2008, [online], [site visited Dec. 12, 2010]. Available from Internet, <URL: <http://www.gsmarena.com>>.*

Huawei U121 telephone, announced 2nd Quarter 2007, [online], [site visited Dec. 12, 2010]. Available from Internet, <URL: <http://www.gsmarena.com>>.*

Motorola W205 telephone, announced Feb. 2007, [online], [site visited Dec. 12, 2010]. Available from Internet, <URL: <http://www.gsmarena.com>>.*

ZTE F103 telephone, announced 2009, [online], [site visited Dec. 12, 2010]. Available from Internet, <URL: <http://www.gsmarena.com>>.*

* cited by examiner

Primary Examiner — Jeffrey D Asch

(74) *Attorney, Agent, or Firm* — Slater & Matsil, L.L.P.

(57) **CLAIM**

The ornamental design for a mobile phone, as shown and described.

DESCRIPTION

FIG. 1 is a bottom view of a mobile phone;

FIG. 2 is a right side view thereof;

FIG. 3 is a front view thereof;

FIG. 4 is a left side view thereof;

FIG. 5 is a back view thereof;

FIG. 6 is a top view thereof; and,

FIG. 7 is a front perspective view thereof.

1 Claim, 5 Drawing Sheets

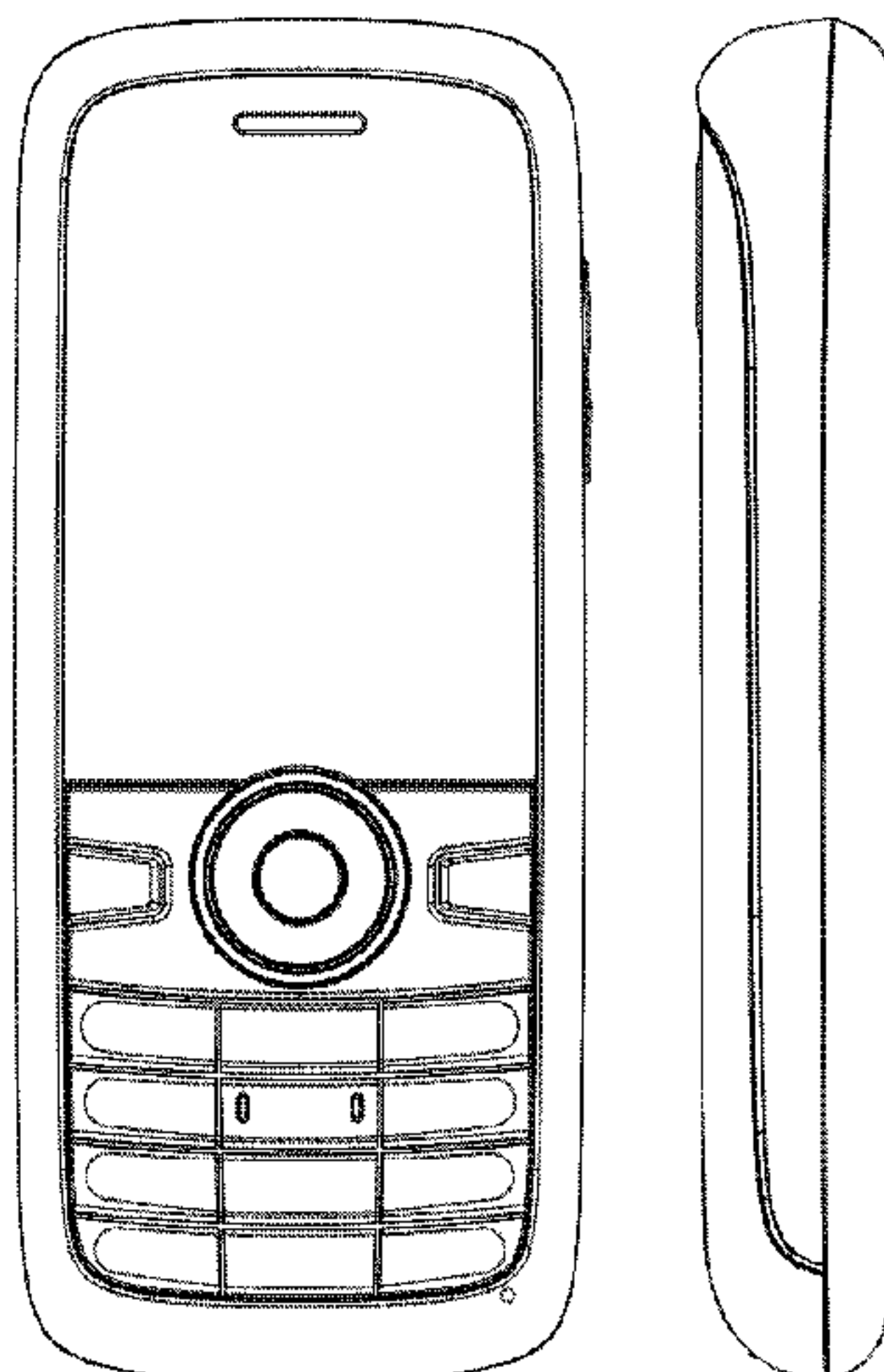

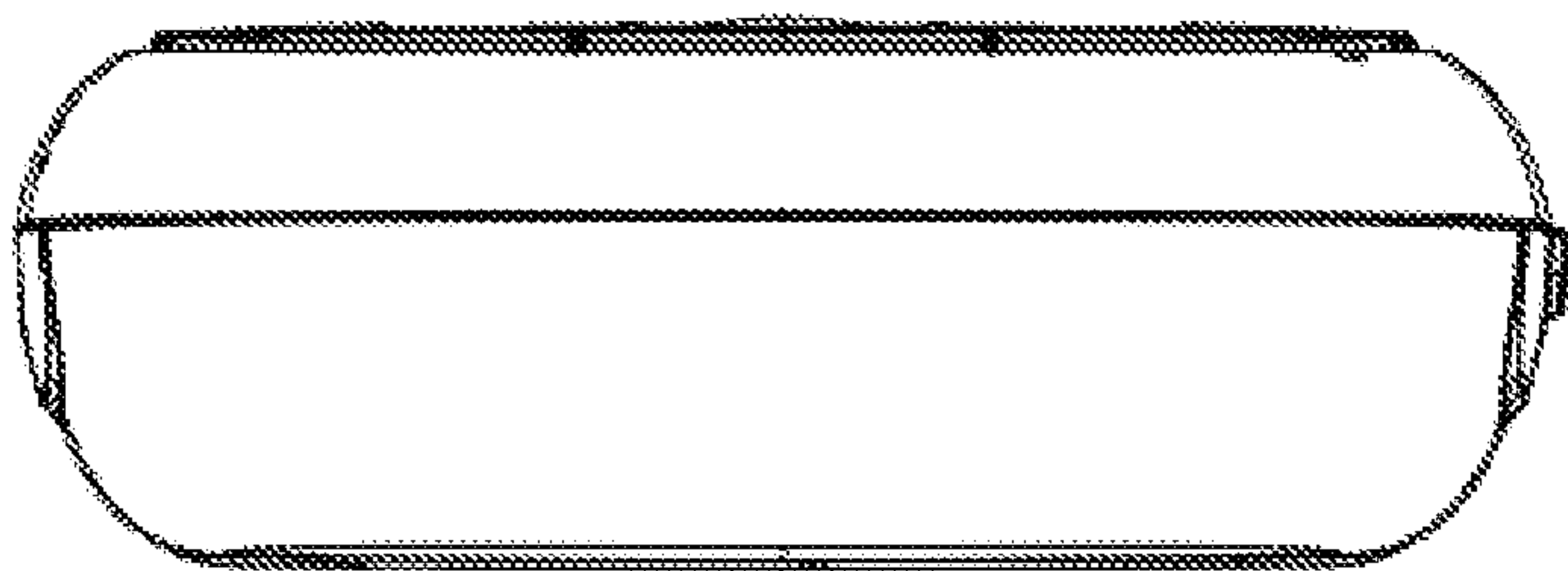

FIG. 1

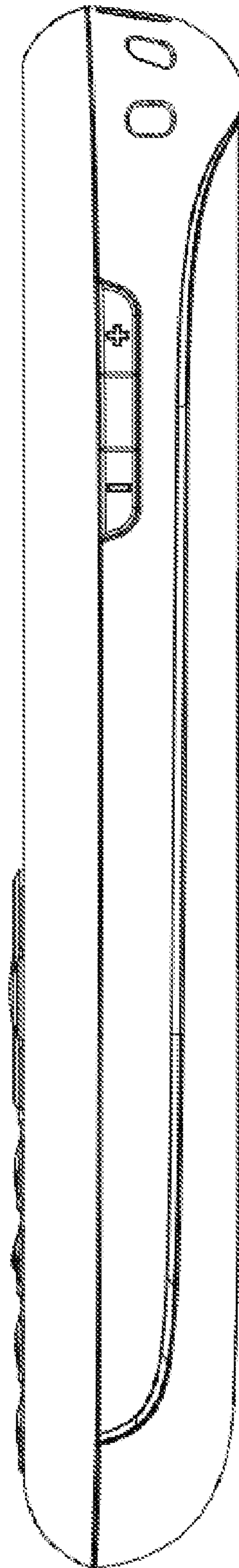

FIG. 2

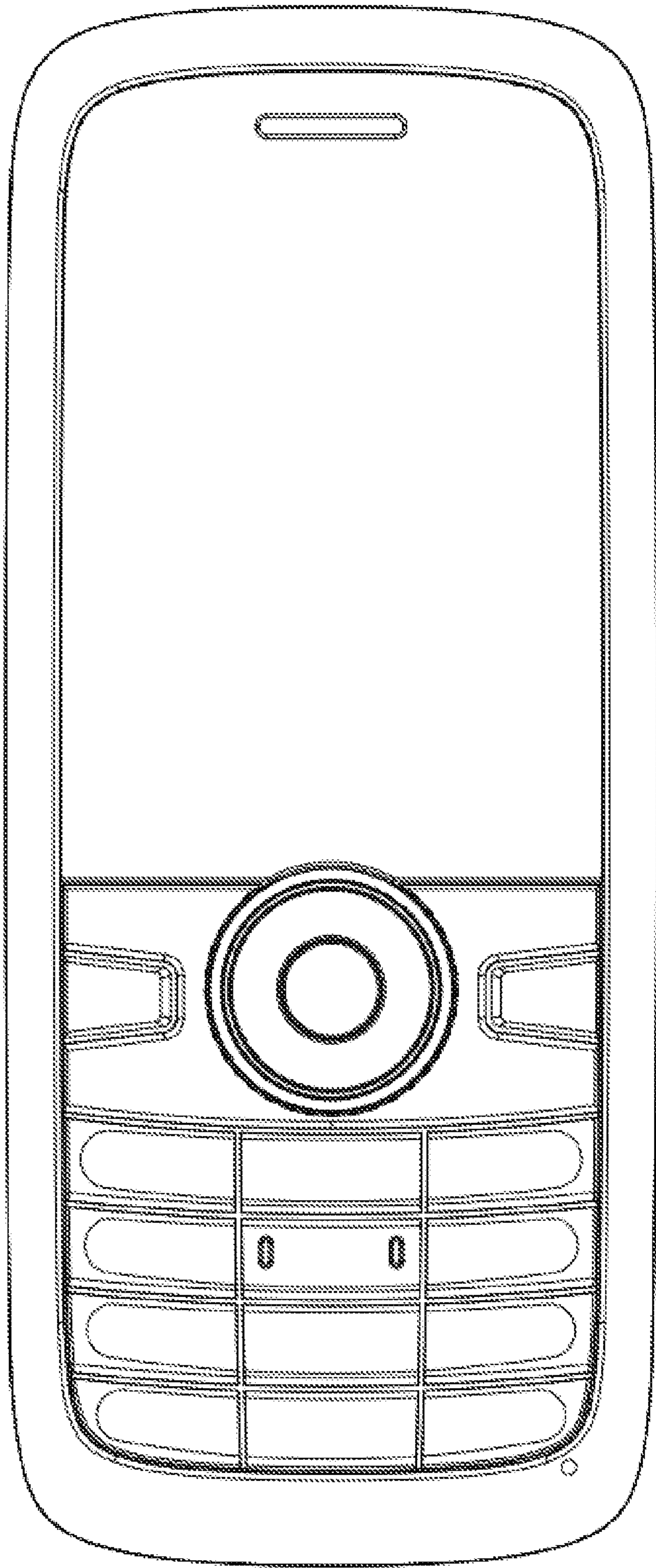

FIG. 3

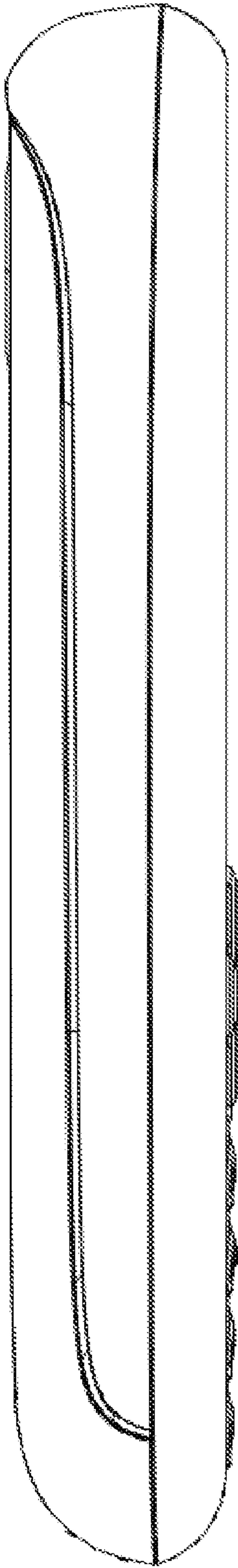

FIG. 4

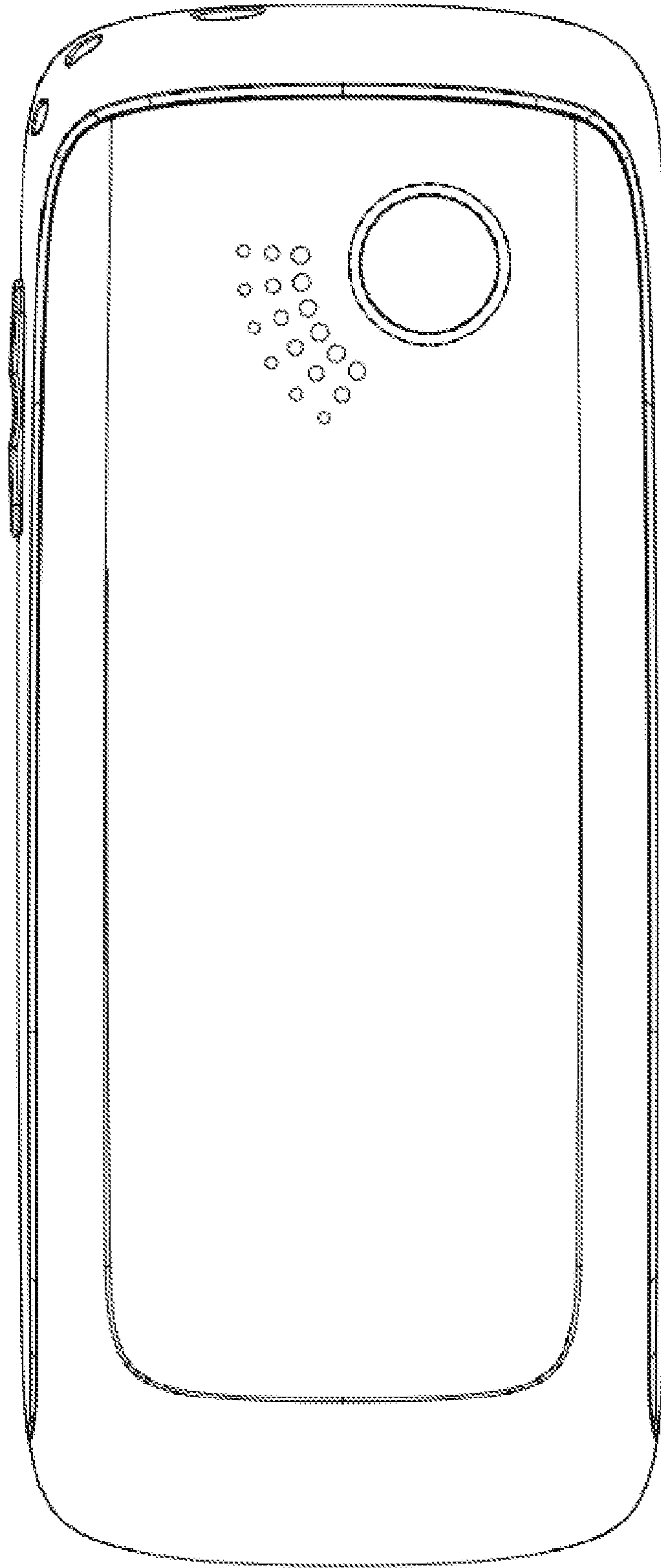

FIG. 5

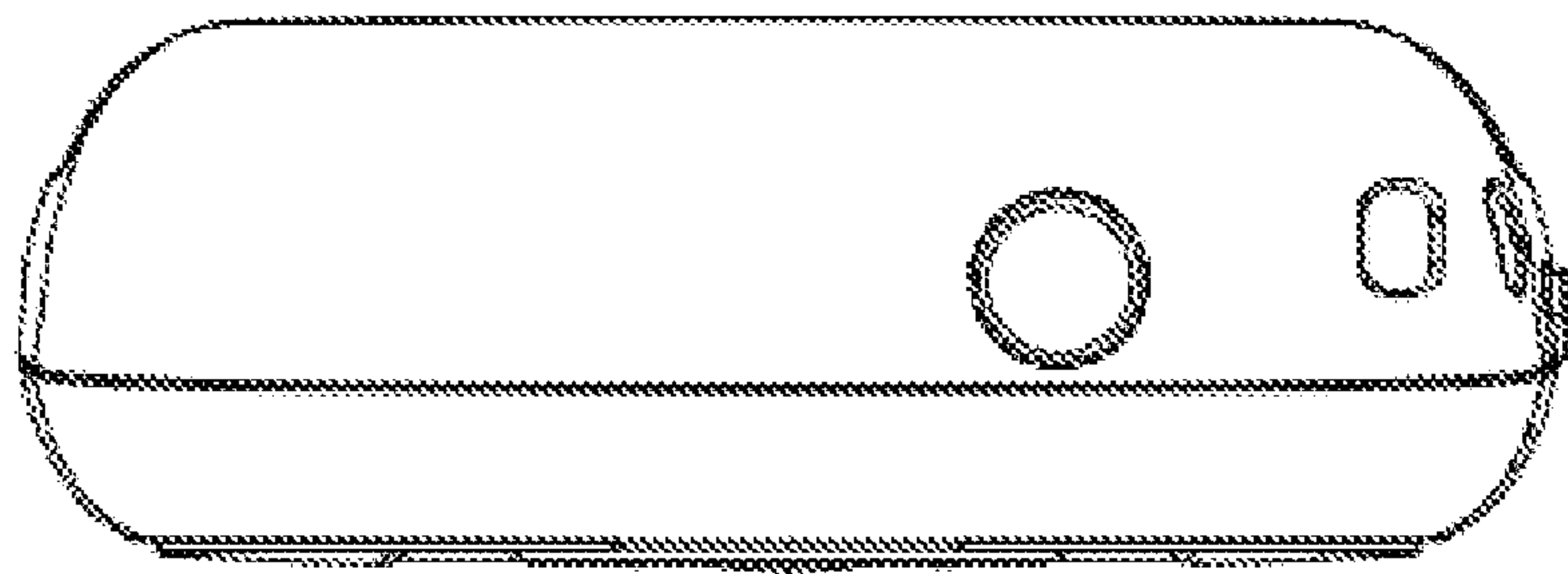

FIG. 6

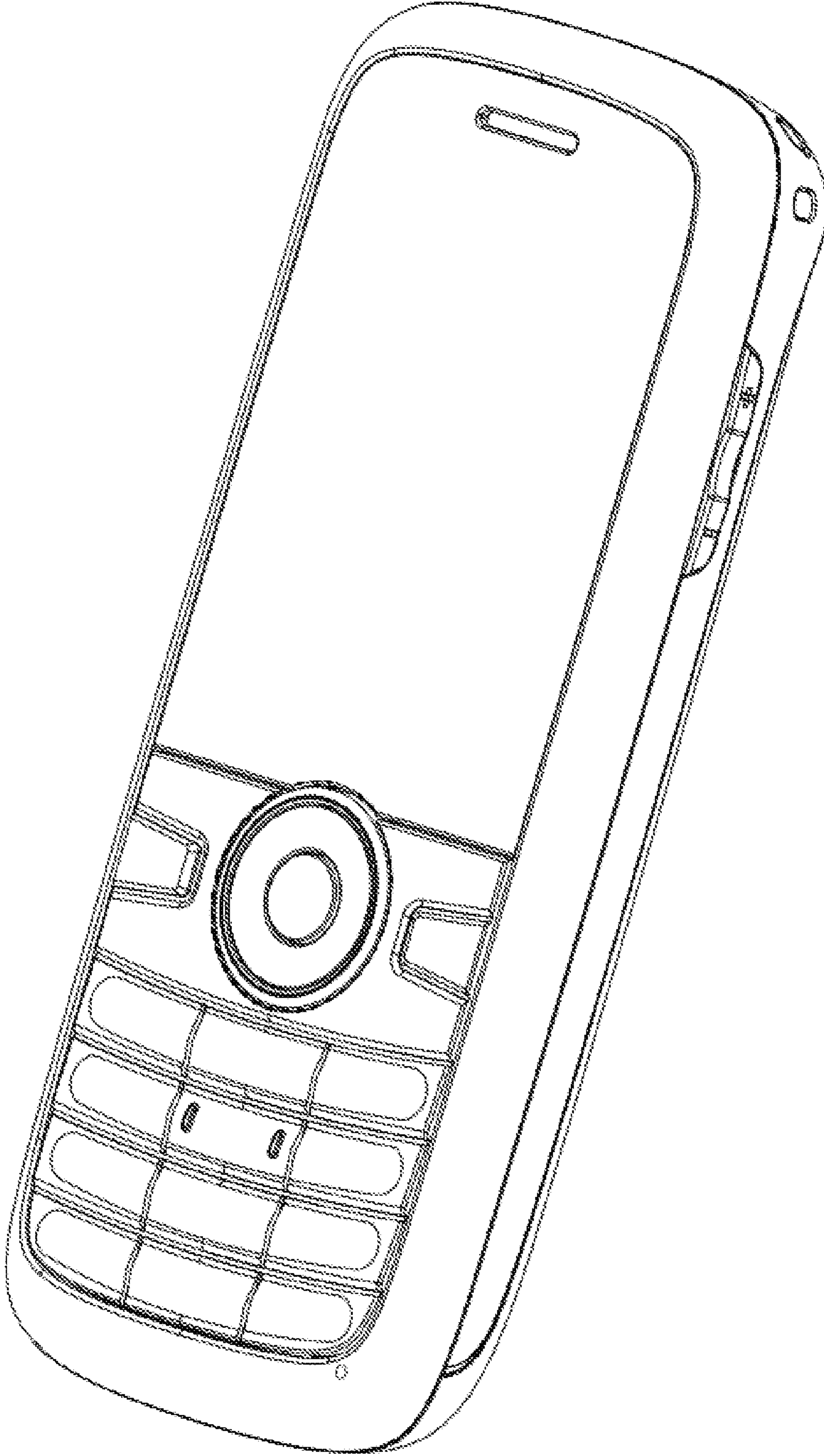

FIG. 7