



US00D649116S

(12) **United States Design Patent**
Nakatsuka

(10) **Patent No.:** **US D649,116 S**

(45) **Date of Patent:** **** Nov. 22, 2011**

(54) **BOOSTER CABLE**

(75) Inventor: **Yoshiaki Nakatsuka**, Nara (JP)

(73) Assignee: **Seiwa Industry Co., Ltd.**, Osaka (JP)

(**) Term: **14 Years**

(21) Appl. No.: **29/312,888**

(22) Filed: **Nov. 19, 2008**

(51) **LOC (9) Cl.** **13-03**

(52) **U.S. Cl.** **D13/120**

(58) **Field of Classification Search** D13/102-107,
D13/110, 118-121, 133, 154, 156, 184; 429/96-100,
429/163, 176; 439/500; 455/343.1

See application file for complete search history.

(56) **References Cited**

U.S. PATENT DOCUMENTS

4,037,720	A *	7/1977	McGurk	206/702
D258,818	S *	4/1981	Johnson et al.	D13/120
4,261,634	A *	4/1981	Robinson	439/668
D304,928	S *	12/1989	Mize	D13/120
4,913,668	A *	4/1990	Chamberlain	439/755
D329,636	S *	9/1992	Nesiba	D13/120
D333,121	S *	2/1993	Craveiro	D13/120
D346,149	S *	4/1994	Deering	D13/120
D351,372	S *	10/1994	Donovan, Jr.	D13/120

D408,785	S *	4/1999	Davis	D13/120
D597,029	S *	7/2009	Li	D13/120
D625,265	S *	10/2010	DuMelle et al.	D13/120

FOREIGN PATENT DOCUMENTS

JP	S62-123021	8/1987
JP	1053974	11/1999
JP	2002-93487	3/2002

* cited by examiner

Primary Examiner — Rosemary K Tarcza

(74) *Attorney, Agent, or Firm* — DLA Piper LLP (US)

(57) **CLAIM**

The ornamental design for a booster cable, as shown and described.

DESCRIPTION

FIG. 1 is a front elevational view of a booster cable showing my new design;
 FIG. 2 is a rear elevational view thereof;
 FIG. 3 is a top plan view thereof;
 FIG. 4 is a bottom plan view thereof;
 FIG. 5 is a left side elevational view thereof;
 FIG. 6 is a right side elevational view thereof; and,
 FIG. 7 is a perspective view of the booster cable with a part of the cable omitted to indicate that the length of the cable is not part of the design.

1 Claim, 7 Drawing Sheets

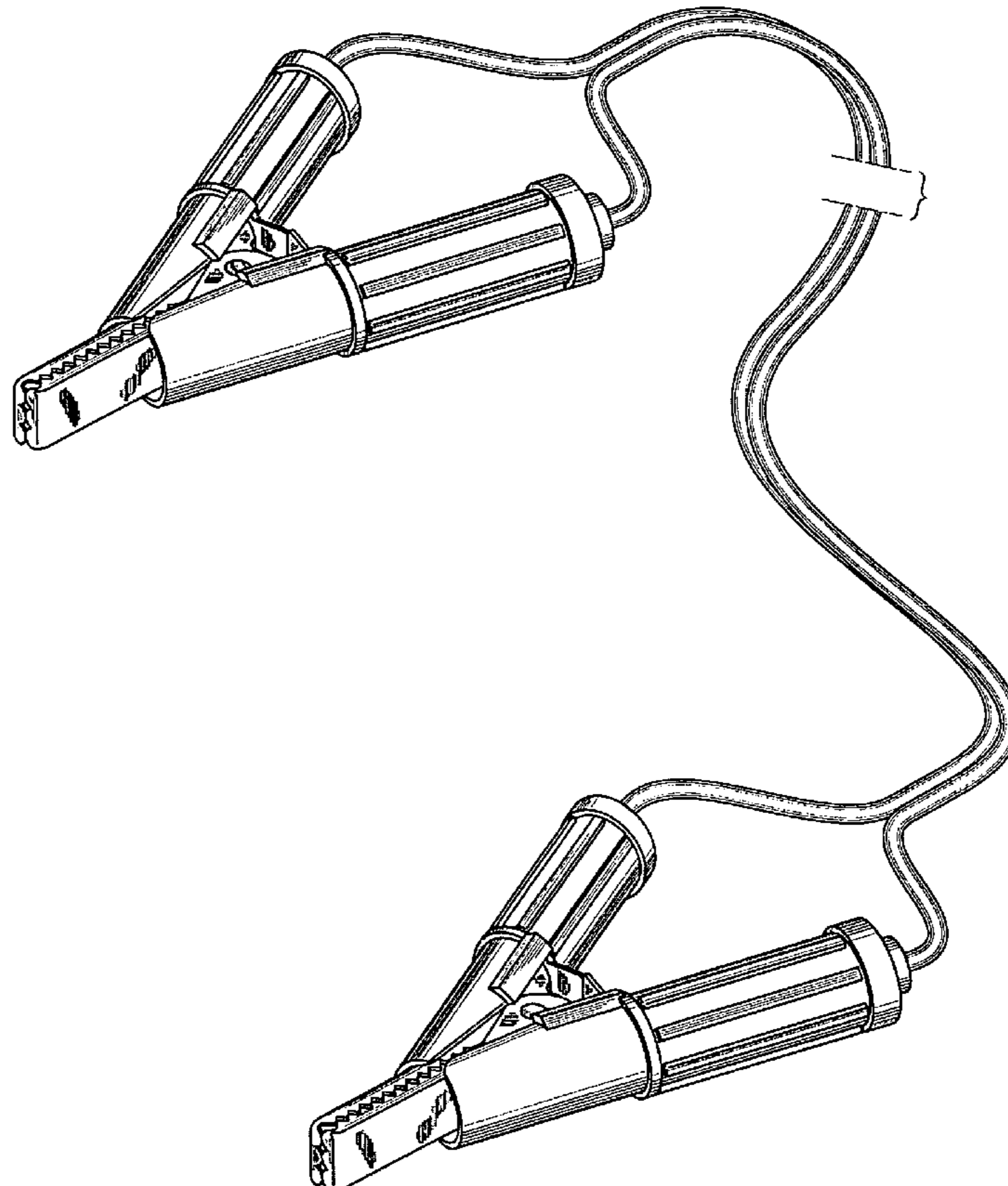

FIG. 1

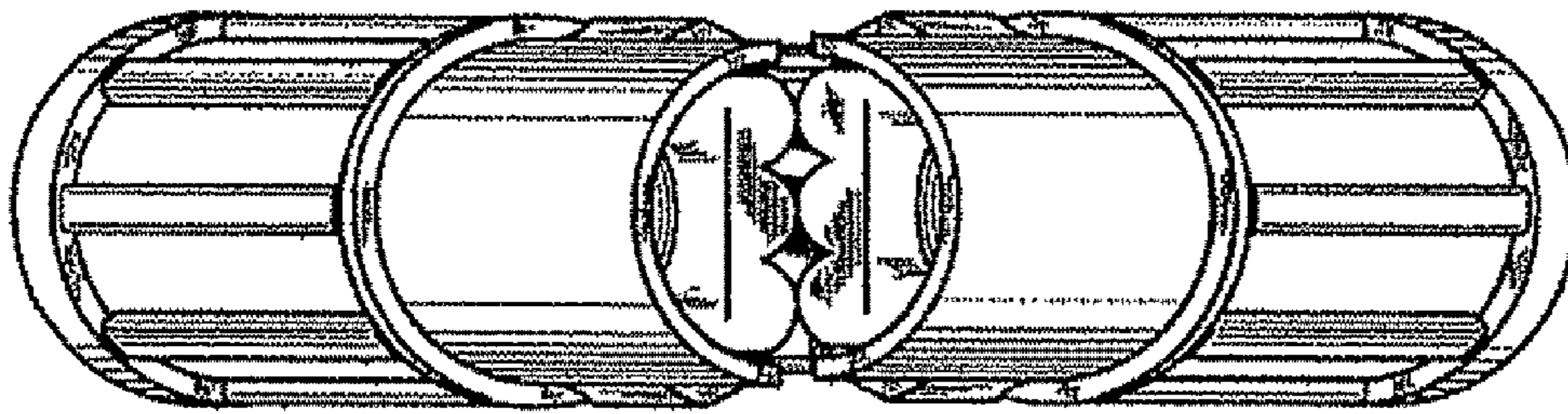

FIG.2

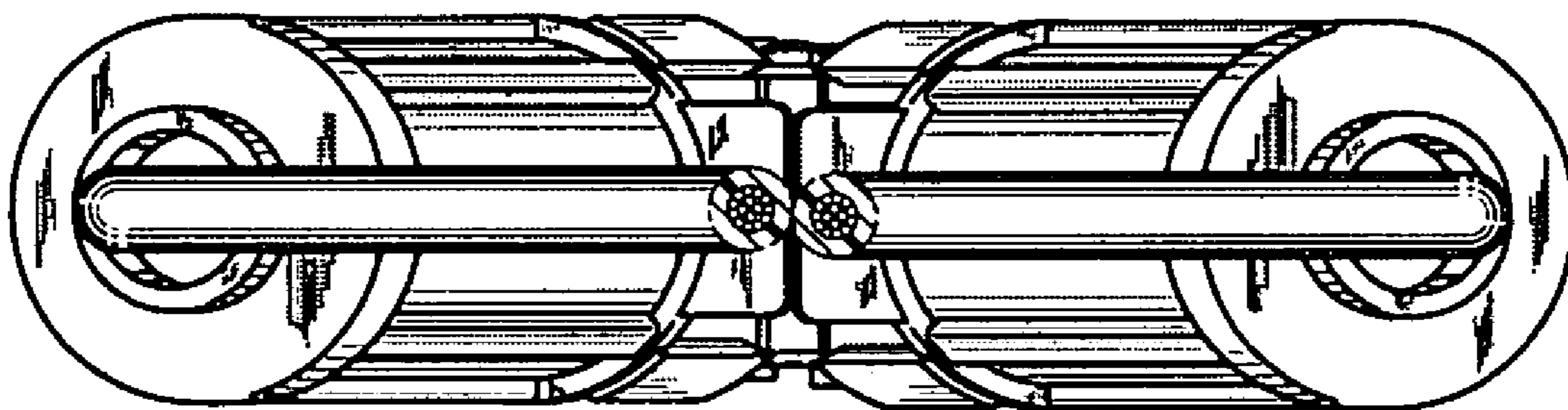

FIG.3

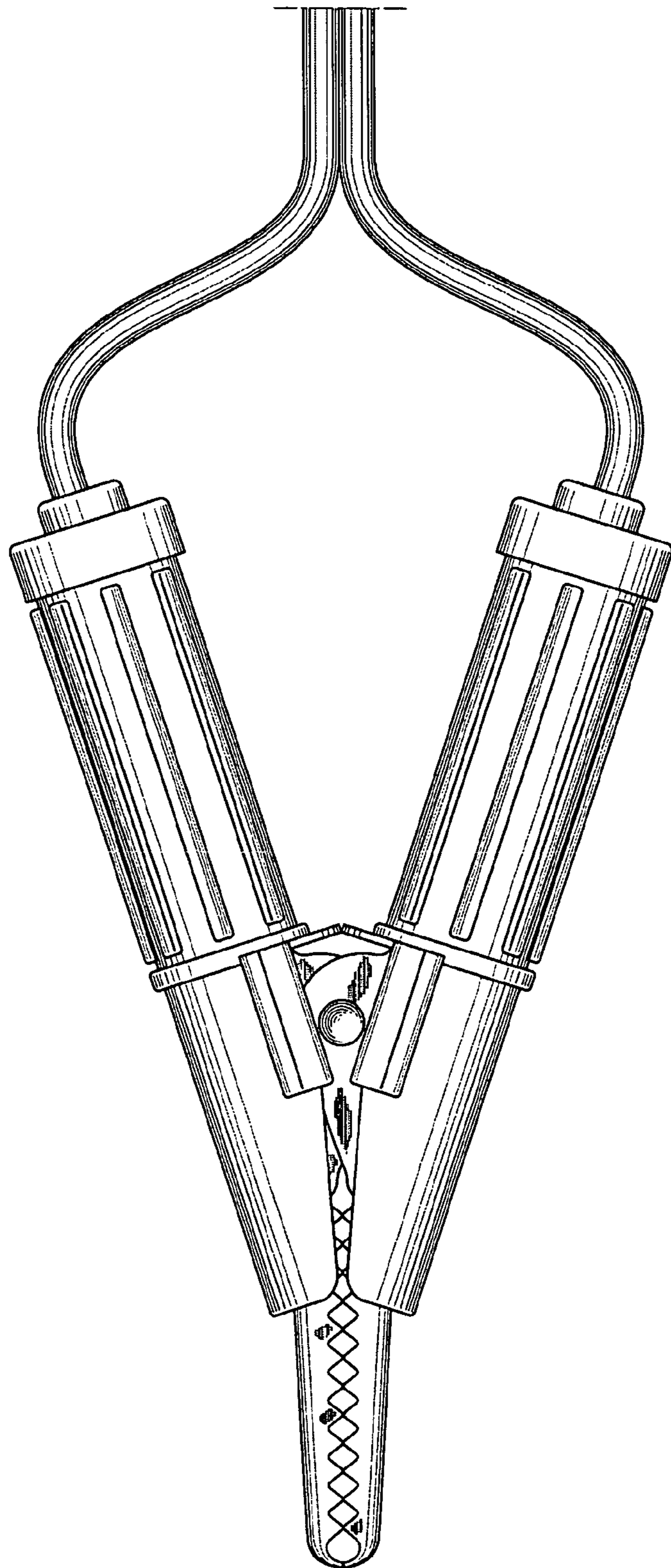

FIG.4

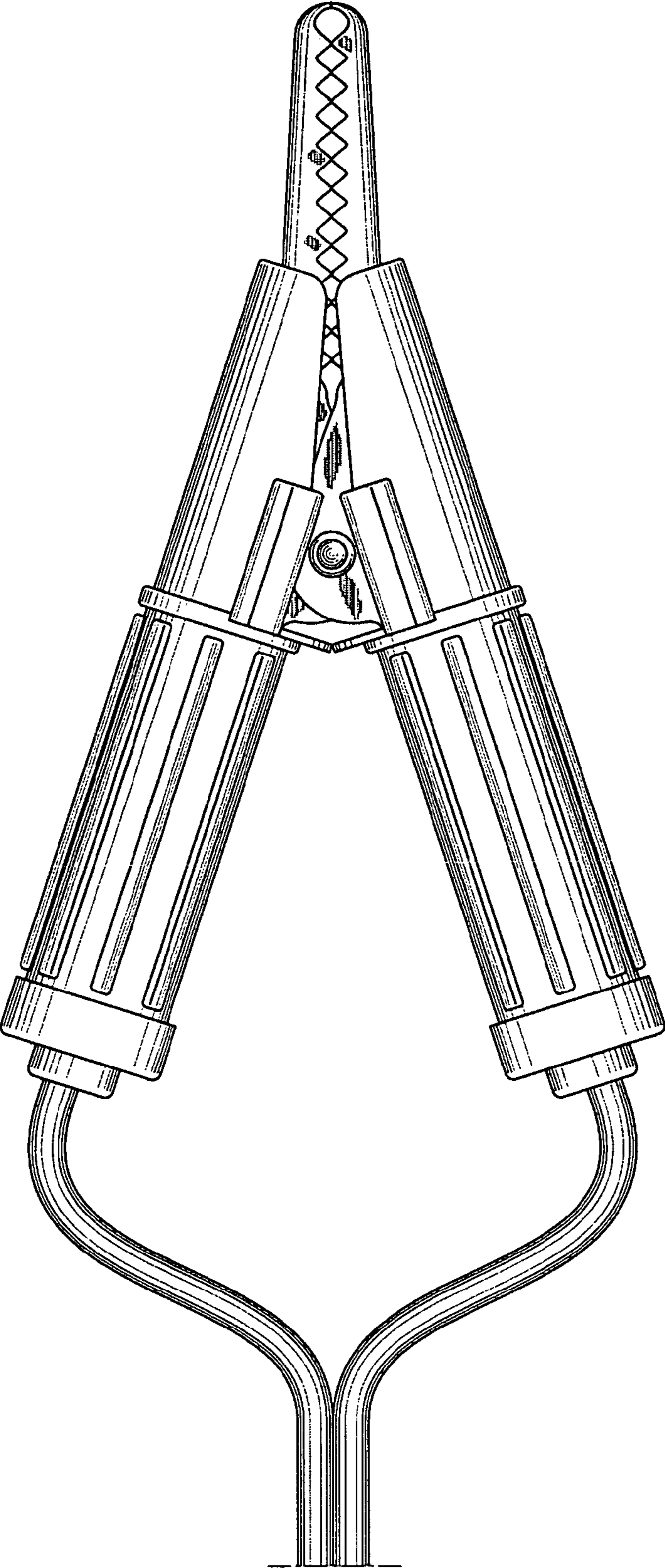

FIG.5

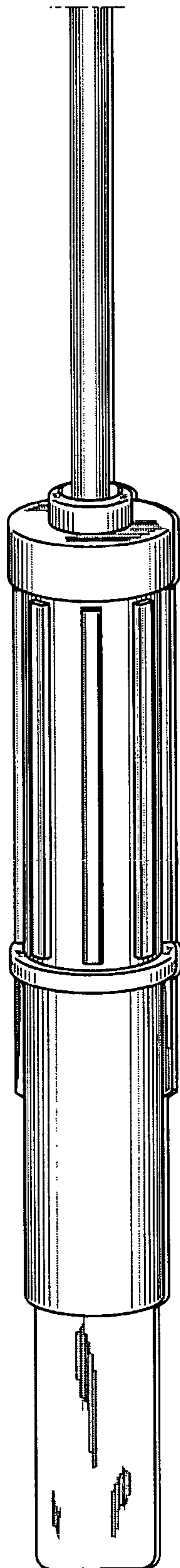

FIG.6

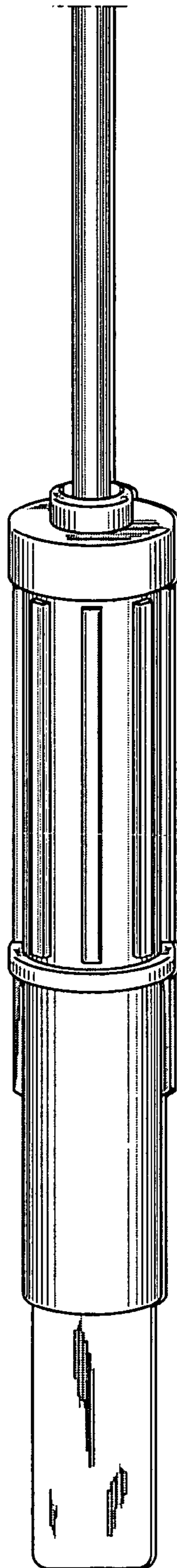

FIG.7

