



US00D649066S

(12) **United States Design Patent**
Arinsmier et al.

(10) **Patent No.:** **US D649,066 S**

(45) **Date of Patent:** **** Nov. 22, 2011**

(54) **COSMETIC PACKAGE**

(75) Inventors: **Keri Marsh Arinsmier**, Cincinnati, OH (US); **Carolina Lavin**, Jersey City, NJ (US)

(73) Assignee: **The Procter & Gamble Company**, Cincinnati, OH (US)

(**) Term: **14 Years**

(21) Appl. No.: **29/366,297**

(22) Filed: **Jul. 22, 2010**

(51) **LOC (9) Cl.** **09-03**

(52) **U.S. Cl.** **D9/697**

(58) **Field of Classification Search** D9/695-699, D9/435, 440, 521, 454, 544, 711, 723-724, D9/499, 712, 449, 727-728, 442, 447, 504; 222/92, 96, 107, 527-529, 215, 491, 206, 222/212-213, 251; 206/438, 822; 220/DIG. 7; D28/7, 76, 82; D24/111, 119; 215/205, 215/321, 381, 382, 316; 141/114-115

See application file for complete search history.

(56) **References Cited**

U.S. PATENT DOCUMENTS

D316,221 S 4/1991 Dombroski
(Continued)

OTHER PUBLICATIONS

Picture of A'Gensn Abundant Olive Series Sunscreen Set, www.gnpd.com; published Nov. 20, 2009; 3 pages.

(Continued)

Primary Examiner — Caron D Veynar

Assistant Examiner — Abraham Bahta

(74) *Attorney, Agent, or Firm* — John G. Powell; Megan C. Hymore

(57) **CLAIM**

The ornamental design for a cosmetic package, as shown and described.

DESCRIPTION

FIG. 1 is a perspective front view of a cosmetic package, embodying the new design;

FIG. 2 is a front view of the design shown in FIG. 1; the back view of the design shown in FIG. 1 is the same;

FIG. 3 is a right side view of the design shown in FIG. 1; the left side view of the design shown in FIG. 1 is the same;

FIG. 4 is a bottom view of the design shown in FIG. 1; and FIG. 5 is a top view of the design shown in FIG. 1.

The two different areas (i.e., lighter and heavier densities) of diagonal line shading in these figures represent two different shades of the color green.

FIG. 6 is a perspective front view of another embodiment of a cosmetic package, embodying the new design;

FIG. 7 is a front view of the design shown in FIG. 6;

FIG. 8 is a back view of the design shown in FIG. 6;

FIG. 9 is a right side view of the design shown in FIG. 6;

FIG. 10 is a bottom view of the design shown in FIG. 6; and FIG. 11 is a top view of the design shown in FIG. 6.

The two different areas (i.e., lighter and heavier densities) of diagonal line shading in these figures represent two different shades of the color green.

FIG. 12 is a perspective front view of another embodiment of a cosmetic package, embodying the new design;

FIG. 13 is a front view of the design shown in FIG. 12;

FIG. 14 is a back view of the design shown in FIG. 12;

FIG. 15 is a right side view of the design shown in FIG. 12;

FIG. 16 is a bottom view of the design shown in FIG. 12; and FIG. 17 is a top view of the design shown in FIG. 12.

The two different areas (i.e., lighter and heavier densities) of diagonal line shading in these figures represent two different shades of the color green.

FIG. 18 is a perspective front view of another embodiment of a cosmetic package, embodying the new design;

FIG. 19 is a front view of the design shown in FIG. 18;

FIG. 20 is a back view of the design shown in FIG. 18;

FIG. 21 is a right side view of the design shown in FIG. 18;

FIG. 22 is a bottom view of the design shown in FIG. 18; and FIG. 23 is a top view of the design shown in FIG. 18.

The two different areas (i.e., lighter and heavier densities) of diagonal line shading in these figures represent two different shades of the color green.

FIG. 24 is a perspective front view of another embodiment of a cosmetic package, embodying the new design;

FIG. 25 is a front view of the design shown in FIG. 24;

FIG. 26 is a back view of the design shown in FIG. 24;

FIG. 27 is a right side view of the design shown in FIG. 24;

FIG. 28 is a bottom view of the design shown in FIG. 24; and, FIG. 29 is a top view of the design shown in FIG. 24.

1 Claim, 19 Drawing Sheets

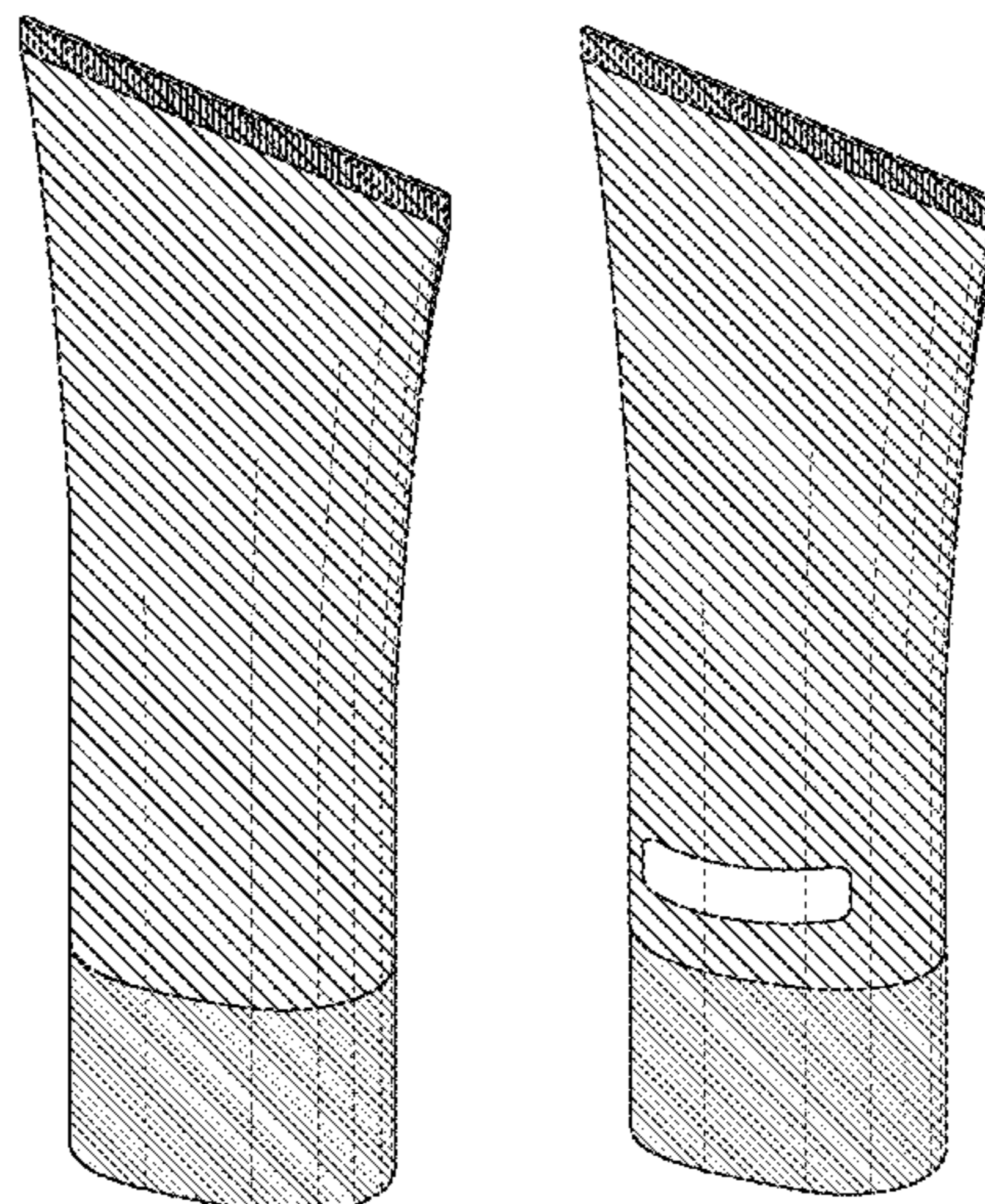

U.S. PATENT DOCUMENTS

5,582,328	A	12/1996	Brown	
D479,722	S *	9/2003	Poon	D15/7
D488,059	S *	4/2004	Mounier	D9/697
D534,081	S *	12/2006	Kazuo et al.	D9/697
D542,672	S *	5/2007	Kenyon	D9/697
D547,671	S *	7/2007	Penfold et al.	D9/697
D547,672	S *	7/2007	Penfold et al.	D9/697
D551,088	S *	9/2007	Dittmer et al.	D9/697
D559,703	S	1/2008	Egawa	
D577,605	S *	9/2008	Py et al.	D9/695
D601,036	S *	9/2009	Palmer et al.	D9/697

OTHER PUBLICATIONS

Picture of Alba Botanica Rainforest Açai Gentle Renewal Scrub, www.gnpd.com; published Aug. 3, 2009; 2 pages.
 Picture of Almay Pure Blends Makeup SPF 20, www.gnpd.com; published Oct. 12, 2009; 2 pages.
 Picture of Atrix Beauty Charge Whitening Hand Cream, www.gnpd.com; published Sep. 30, 2009; 1 page.
 Picture of Bobbi Brown ColorOptions Creamy Color, www.gnpd.com; published Sep. 2001; 2 pages.
 Picture of Bobbi Brown Lash Glamour, www.gnpd.com; published; May 2003; 1 page.
 Picture of Clark's Botanicals Ultra Rich Lip Balm, www.gnpd.com; published Oct. 2007; 2 pages.
 Picture of Conceal FX Camouflage Concealer, www.gnpd.com; published Aug. 14, 2009; 3 pages.
 Picture of Cristian Lay Bio Salud, www.gnpd.com; published Nov. 4, 2009; 2 pages.
 Picture of DeMillus Erva Doce Creme de Mãos (Anise Hand Cream), www.gnpd.com; published Jun. 3, 2009; 2 pages.
 Picture of Dr Irena Eris Under Twenty Make-Up Cream, www.gnpd.com; published Nov. 14, 2007; 2 pages.
 Picture of Flores & Vegetais Creme Facial Pepino (Cucumber Face Cream), www.gnpd.com; published Nov. 2009; 2 pages.
 Picture of Gemey Maybelline Cil Definition Mascara Longueur Cil à Cil Waterproof (Waterproof Lengthening Mascara), www.gnpd.com; published Apr. 2008; 2 pages.
 Picture of L'Oréal Cashmere Perfect Soft Powdercreme Makeup, www.gnpd.com; published Mar. 31, 2005; 2 pages.
 Picture of Lumene Double Stay Mineral Makeup, www.gnpd.com; published Apr. 7, 2009; 1 page.
 Picture of Maybelline Affinitone Perfecting & Protecting Foundation with vitamin E, www.gnpd.com; published Oct. 6, 2009; 2 pages.
 Picture of Maybelline Instant Smooth Result Foundation, www.gnpd.com; published Dec. 4, 2006; 1 page.

Picture of Miss Sporty Studio Lash Eye Opening & Lash Sculpting Mascara, www.gnpd.com; published Jun. 2008; 2 pages.
 Picture of Natura Faces Base Extra Leve FPS 8 (Extra-Soft Foundation SPF 8), www.gnpd.com; published Oct. 26, 2009; 2 pages.
 Picture of Neutrogena 3-In-1 Concealer for Eyes, www.gnpd.com; published Apr. 2007; 3 pages.
 Picture of Neutrogena Healthy Skin Glow Sheers Foundation, www.gnpd.com; Apr. 2007; 3 pages.
 Picture of Neutrogena Norwegische Formel (Anti-Callosity Foot Creme), www.gnpd.com; published Aug. 2007; 2 pages.
 Picture of Neutrogena Reafirmante Corporal (Firming Body Moisturizer), www.gnpd.com; published May 2007; 2 pages.
 Picture of No7 Essential Moisture Foundation SPF 12, www.gnpd.com; published Jun. 2006; 2 pages.
 Picture of Only Acne Oil Control Facial Cleansing Foam, www.gnpd.com; published Sep. 10, 2009; 1 page.
 Picture of Palmer's Olive Oil Formula Regenerating Conditioner, www.gnpd.com; published Mar. 2008; 2 pages.
 Picture of Physicians Formula Lash-in-a-Tube Full Coverage Cream Mascara, www.gnpd.com; published Feb. 2004; 2 pages.
 Picture of Physicians Formula Organic Wear Fair to Light Tinted Moisturizer, www.gnpd.com; published Jan. 2008; 3 pages.
 Picture of Purab Green Herbal Foam, www.gnpd.com; published May 5, 2009; 1 page.
 Picture of Revlon ColorStay Mineral Mousse Foundation, www.gnpd.com; published Nov. 26, 2009; 1 page.
 Picture of Revlon Colorstay Mineral Mousse Makeup, www.gnpd.com; published May 28, 2009; 2 pages.
 Picture of Rimmel Stay Matte Clarifying Matte Foundation, www.gnpd.com; published Jan. 28, 2009; 2 pages.
 Picture of Rimmel Stay Matte, www.gnpd.com; published Nov. 13, 2009; 2 pages.
 Picture of Sabra Creme de Arnica com Mentol Arnica Cream with Menthol, www.gnpd.com; published Jun. 2005; 2 pages.
 Picture of Universo Garden Angels Gel Revitalizante para Piernas Cansadas (Revitalizing Gel for Tired Legs), www.gnpd.com; published Nov. 6, 2009; 1 page.
 Picture of Victoria's Secret Beauty Rush Mascara, www.gnpd.com; published Dec. 2008; 2 pages.
 U.S. Appl. No. 29/366,274, filed Jul. 22, 2010, Keri Marsh Arinsmier.
 U.S. Appl. No. 29/366,278, filed Jul. 22, 2010, Keri Marsh Arinsmier.
 U.S. Appl. No. 29/366,281, filed Jul. 22, 2010, Keri Marsh Arinsmier.
 U.S. Appl. No. 29/366,285, filed Jul. 22, 2010, Keri Marsh Arinsmier.
 U.S. Appl. No. 29/366,295, filed Jul. 22, 2010, Keri Marsh Arinsmier.
 U.S. Appl. No. 29/366,312, filed Jul. 22, 2010, Keri Marsh Arinsmier.

* cited by examiner

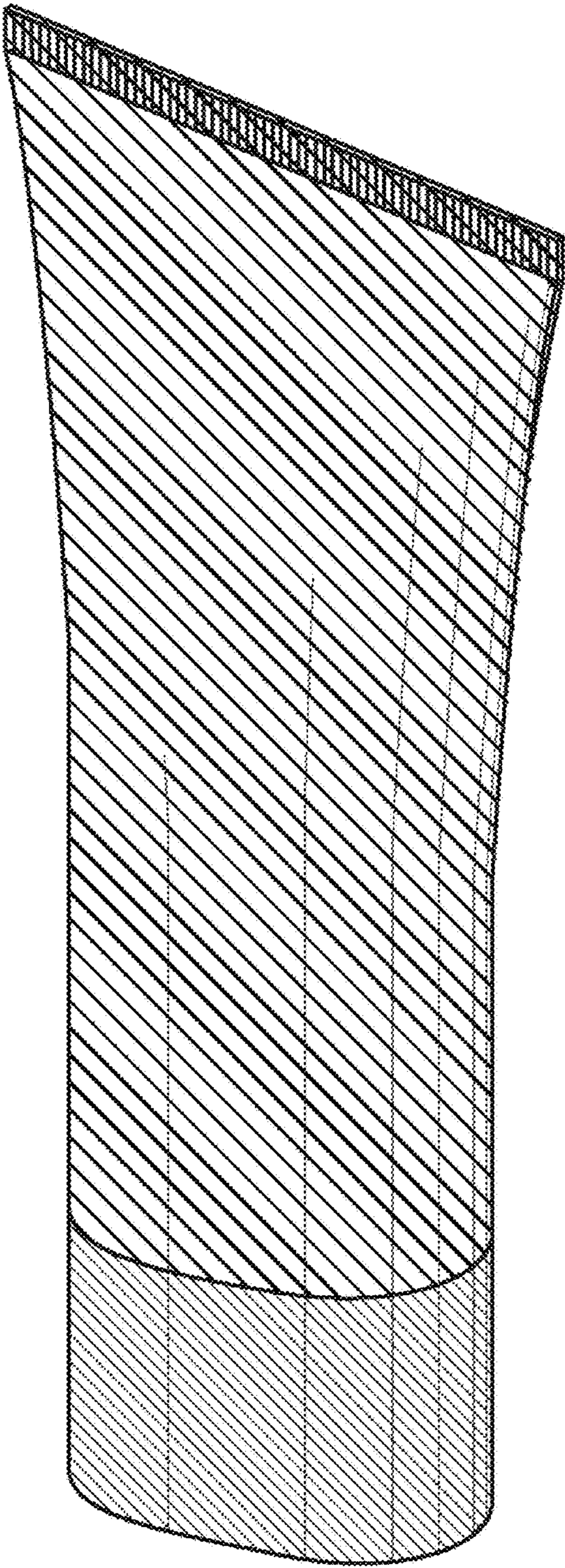

Fig. 1

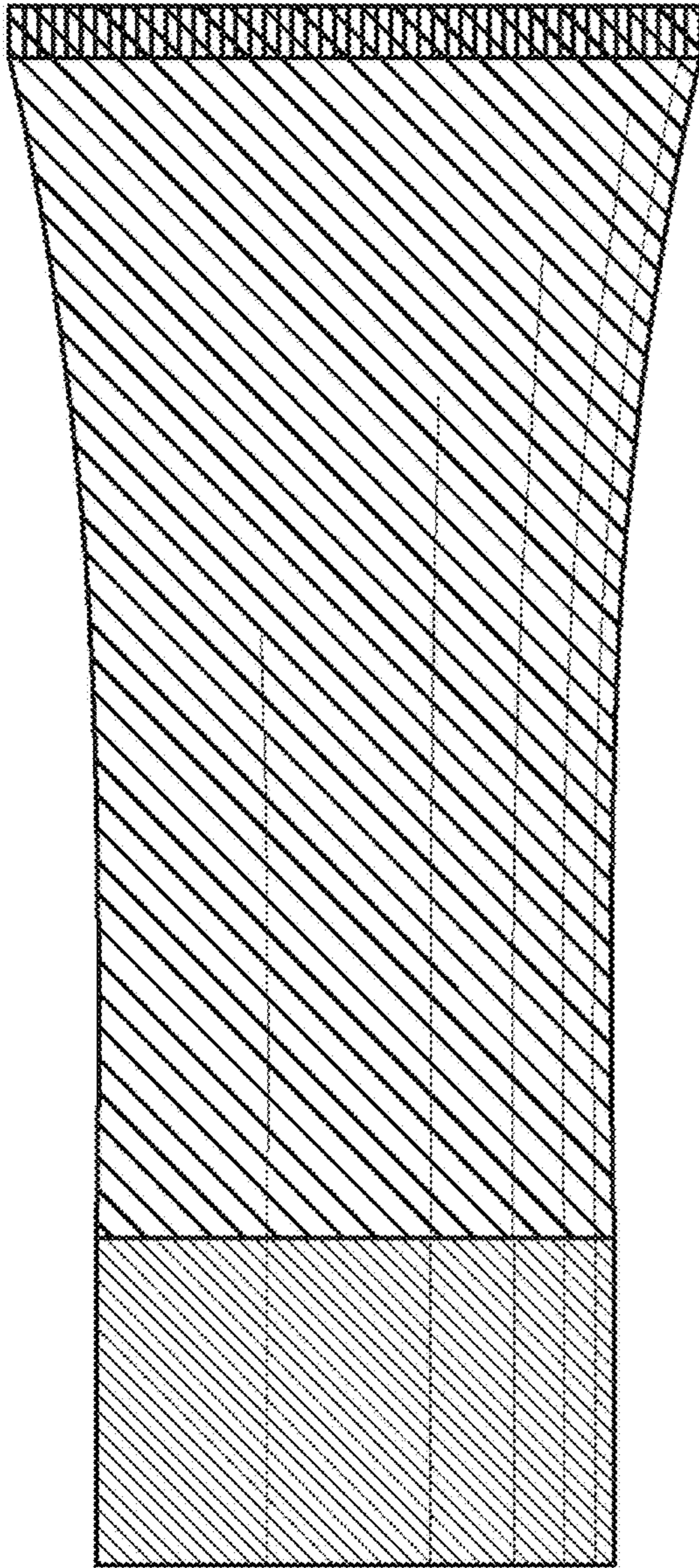

Fig. 2

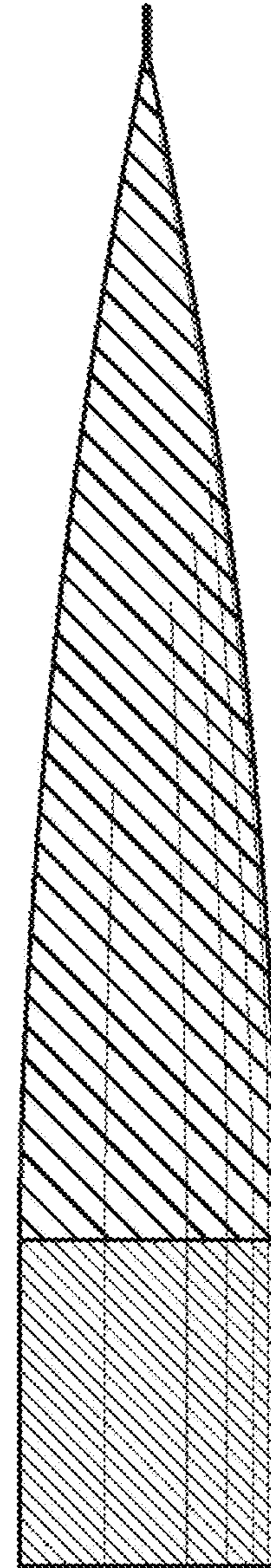

Fig. 3

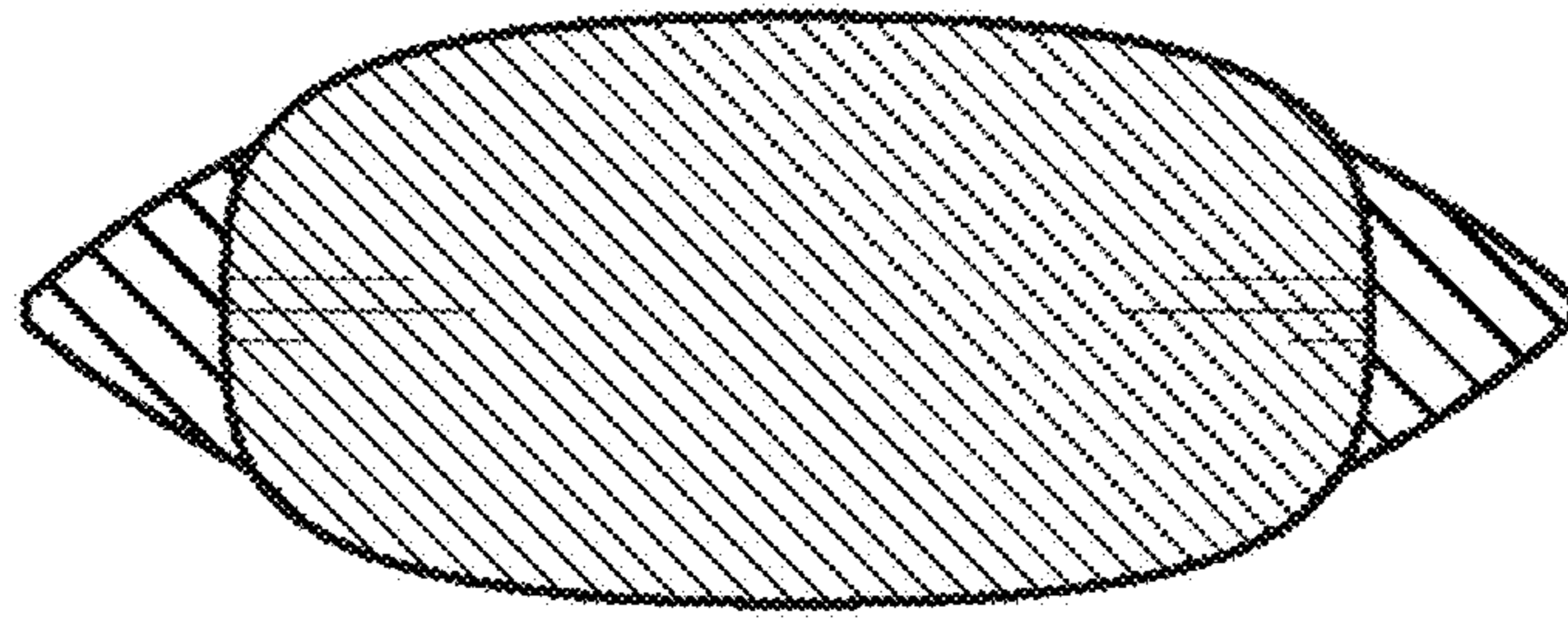

Fig. 4

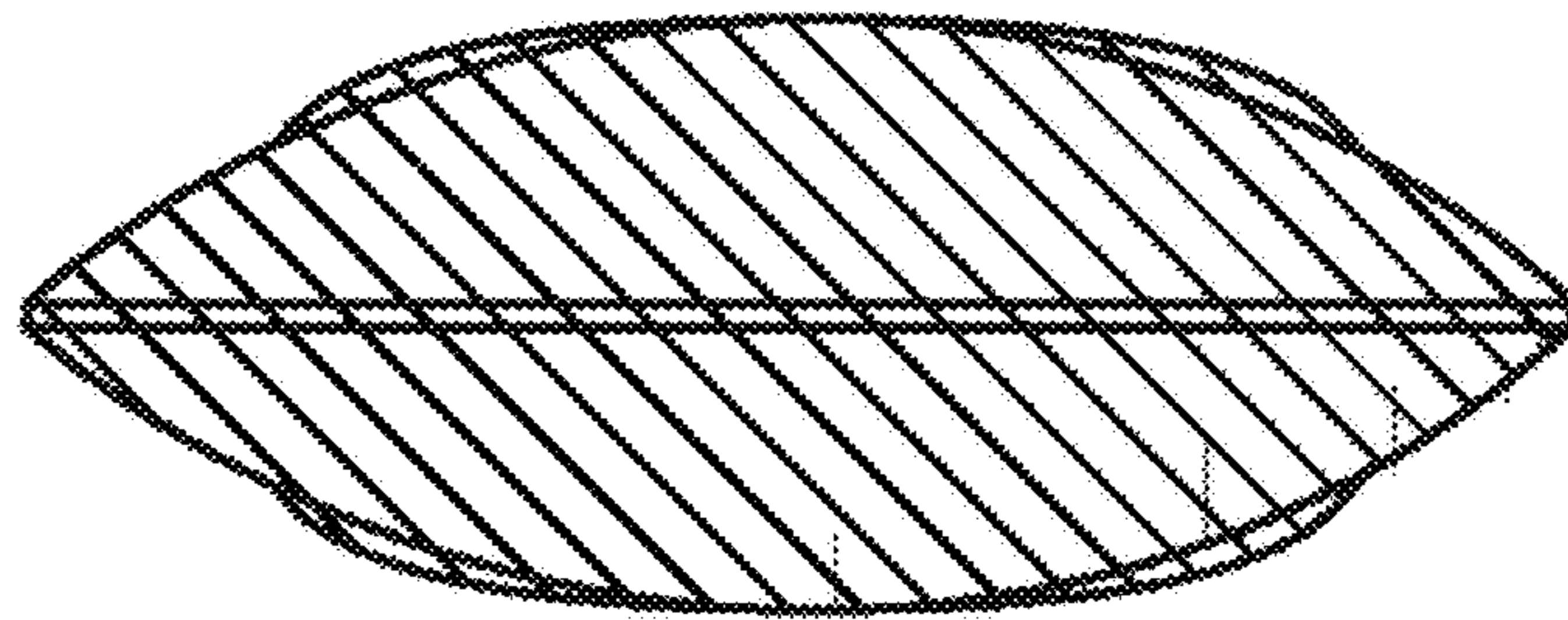

Fig. 5

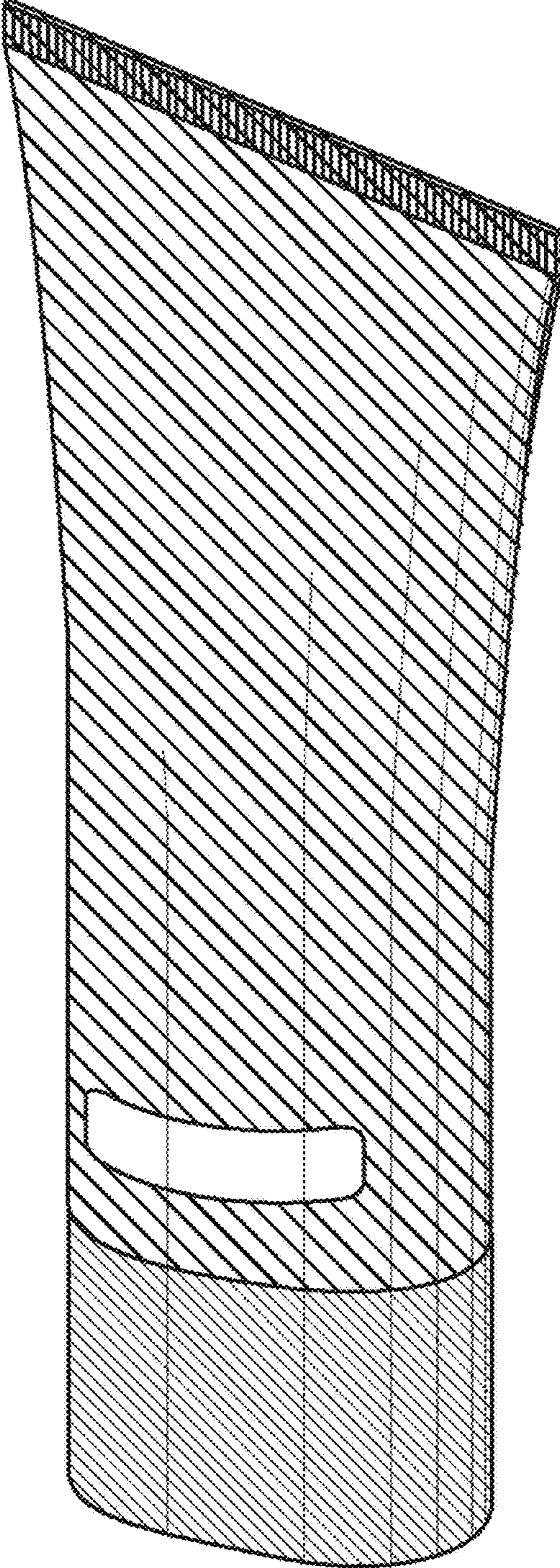

Fig. 6

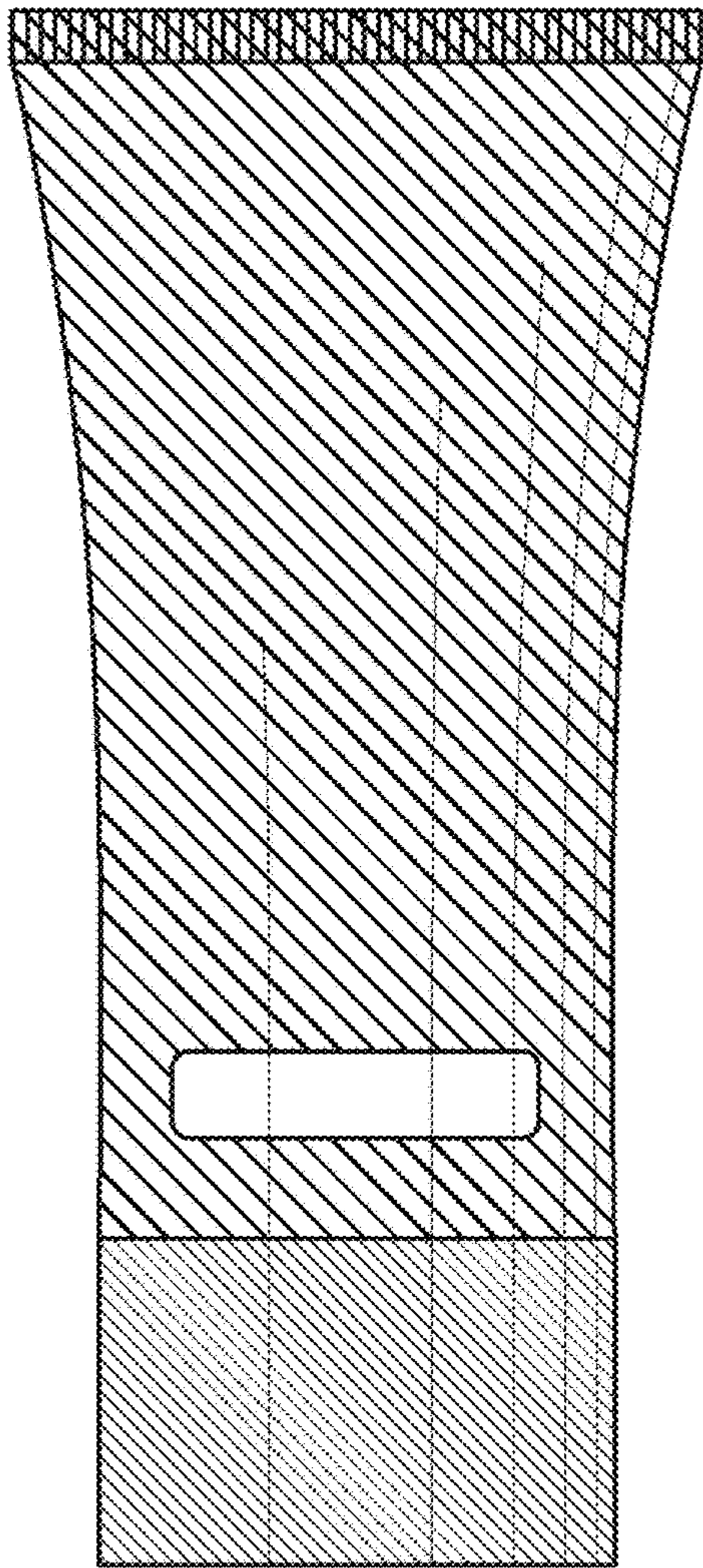

Fig. 7

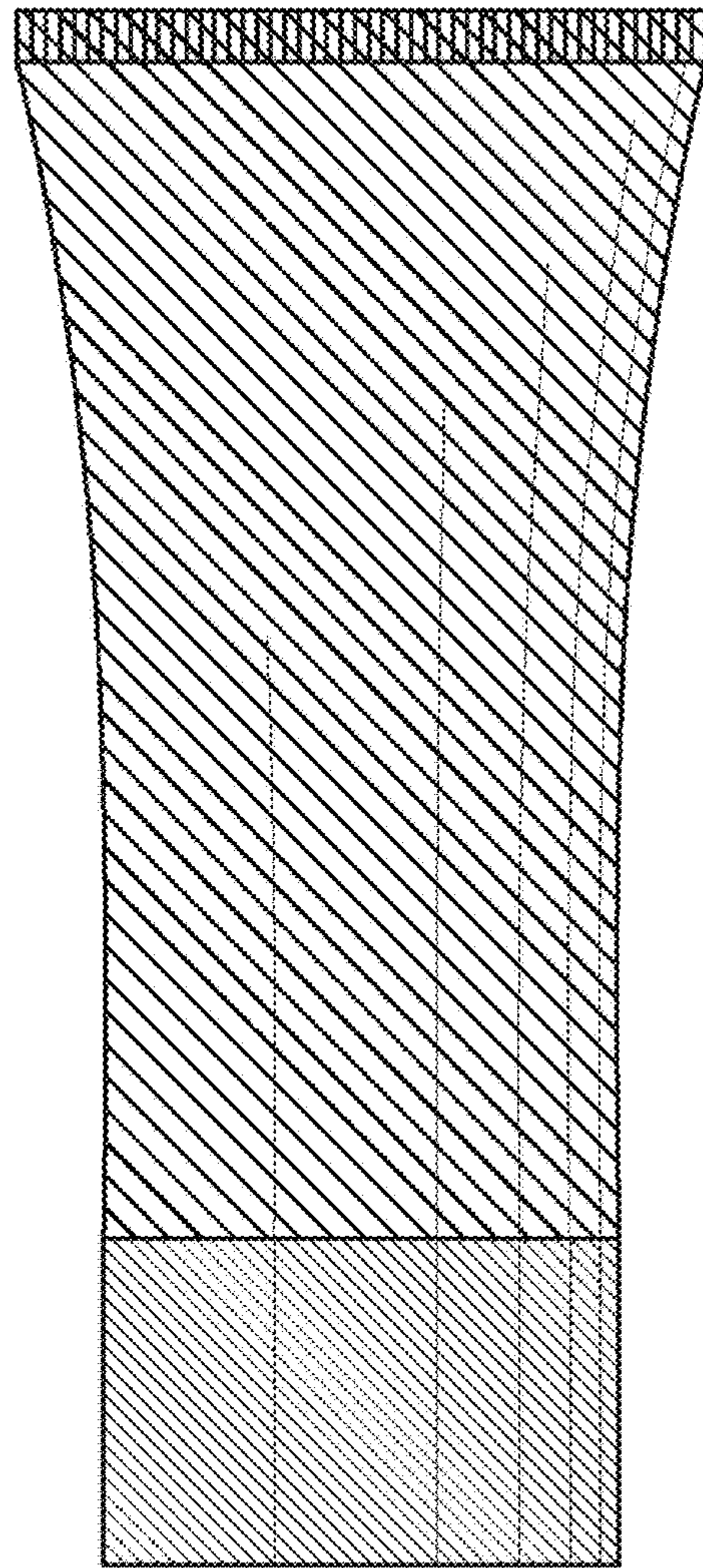

Fig. 8

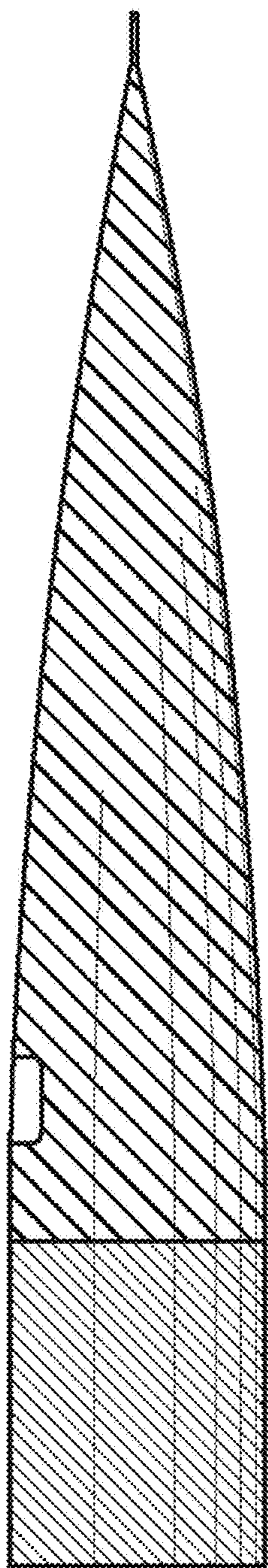

Fig. 9

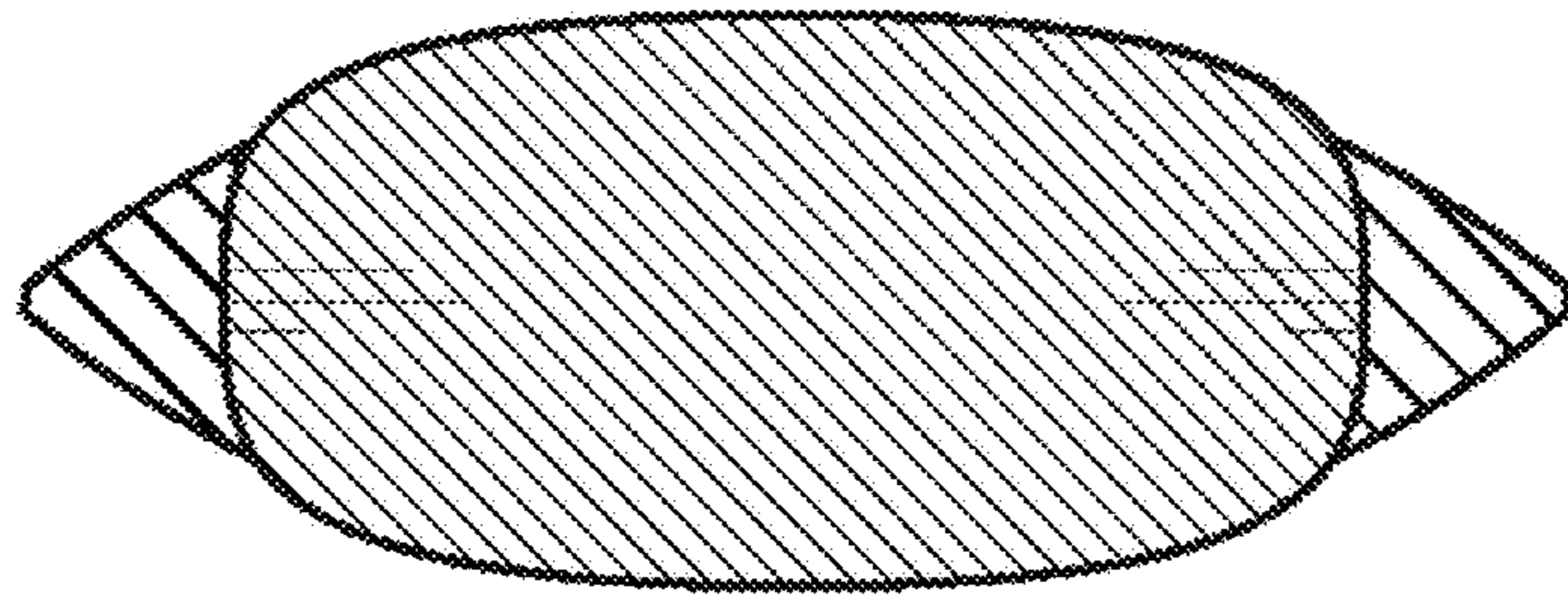

Fig. 10

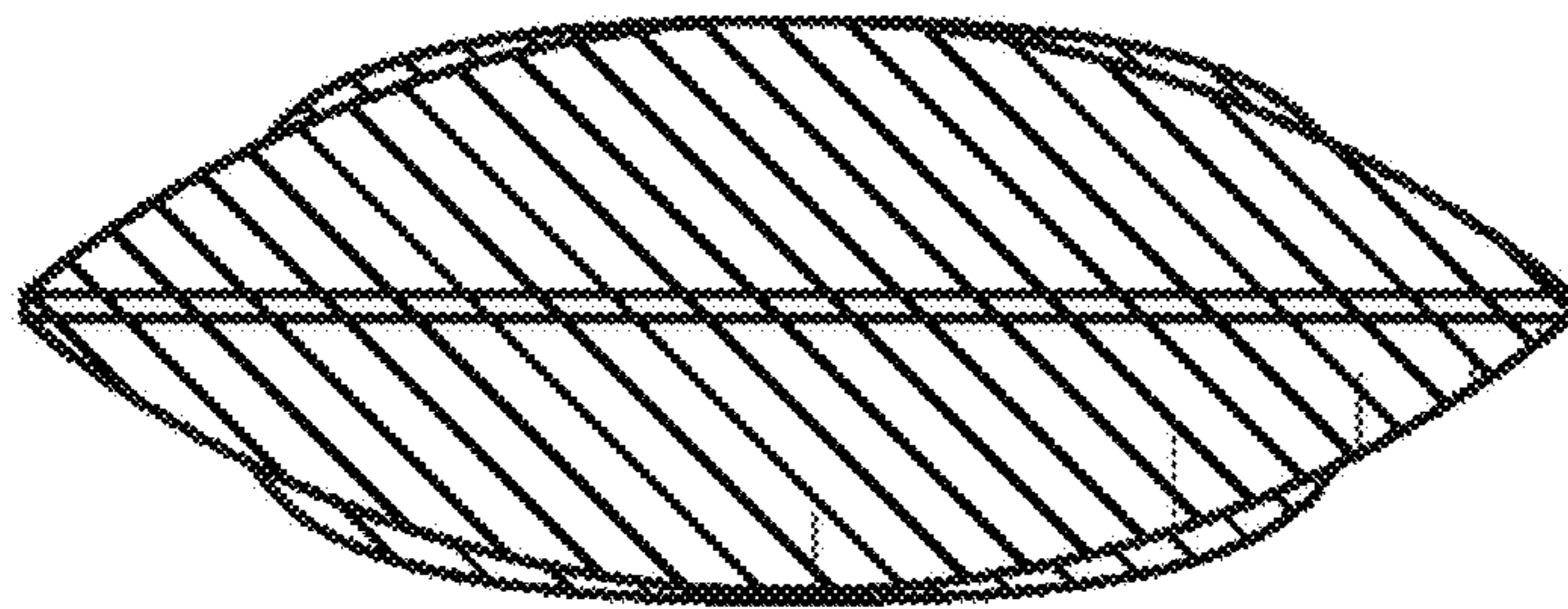

Fig. 11

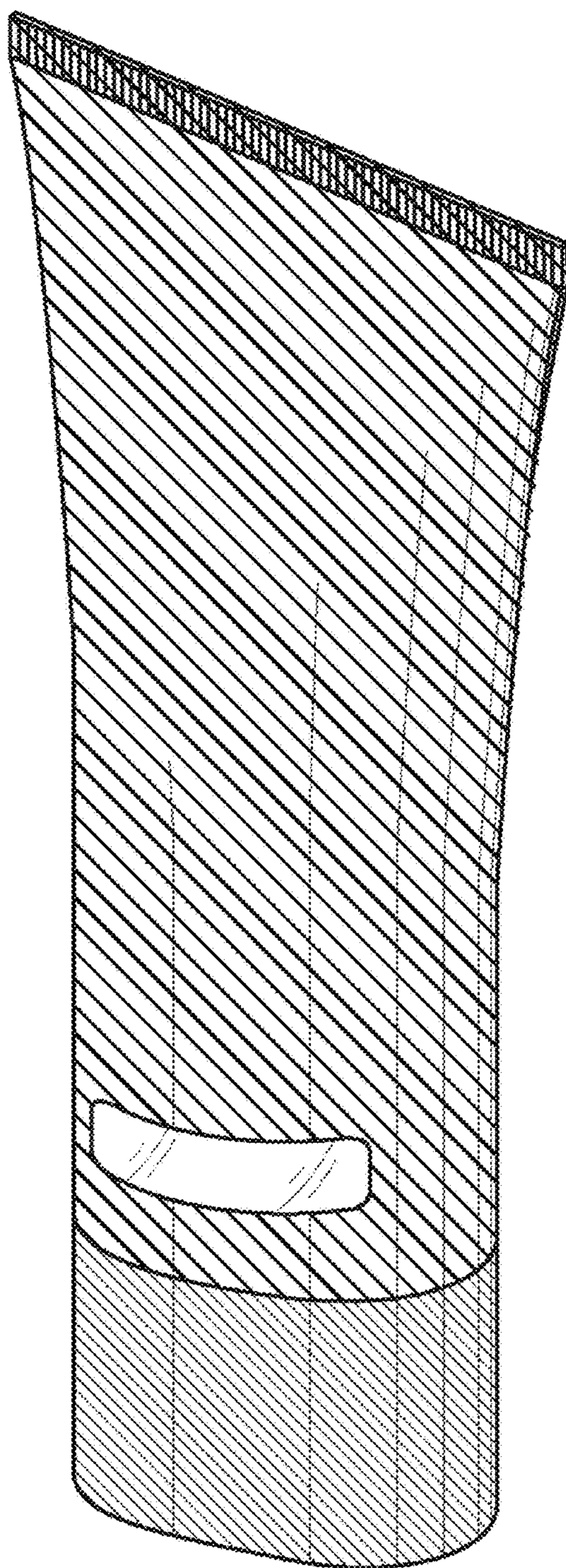

Fig. 12

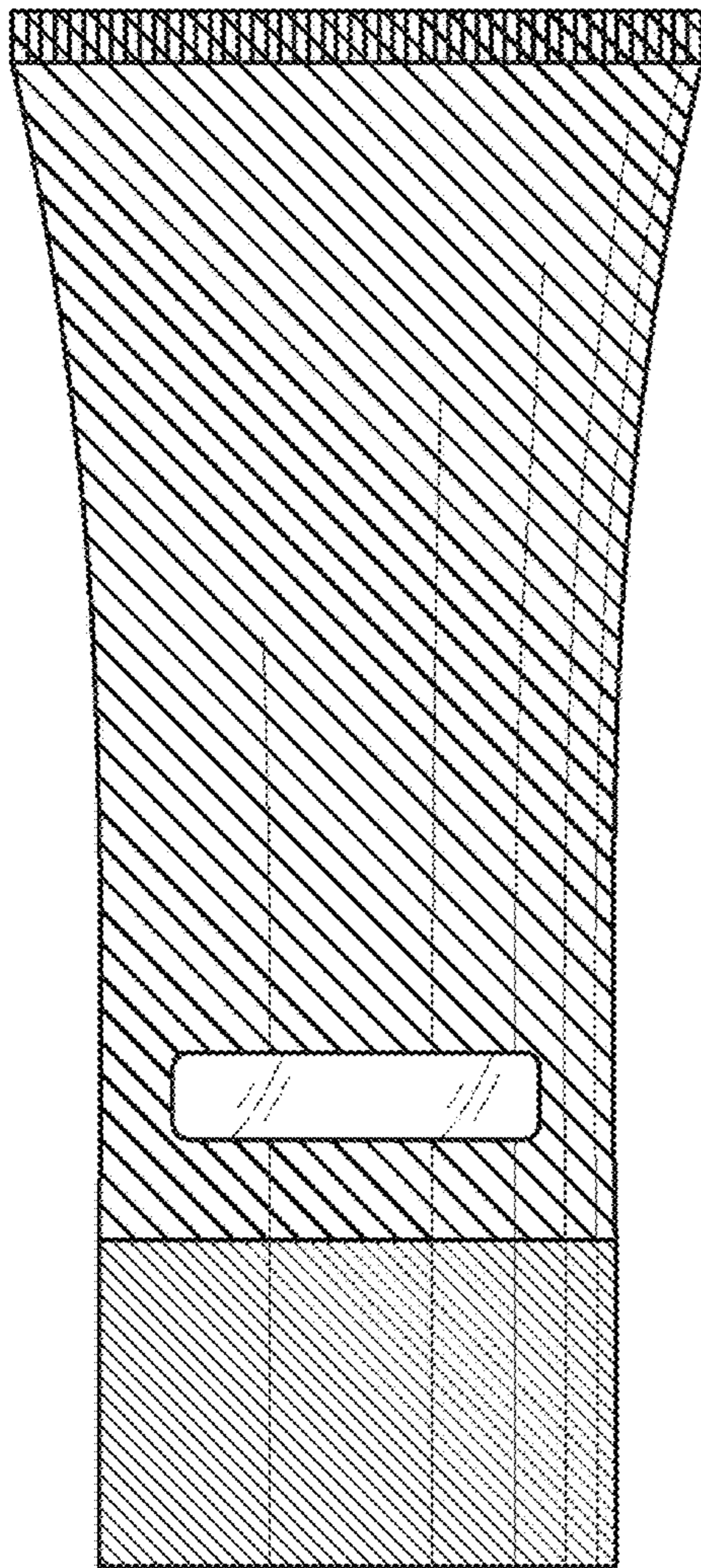

Fig. 13

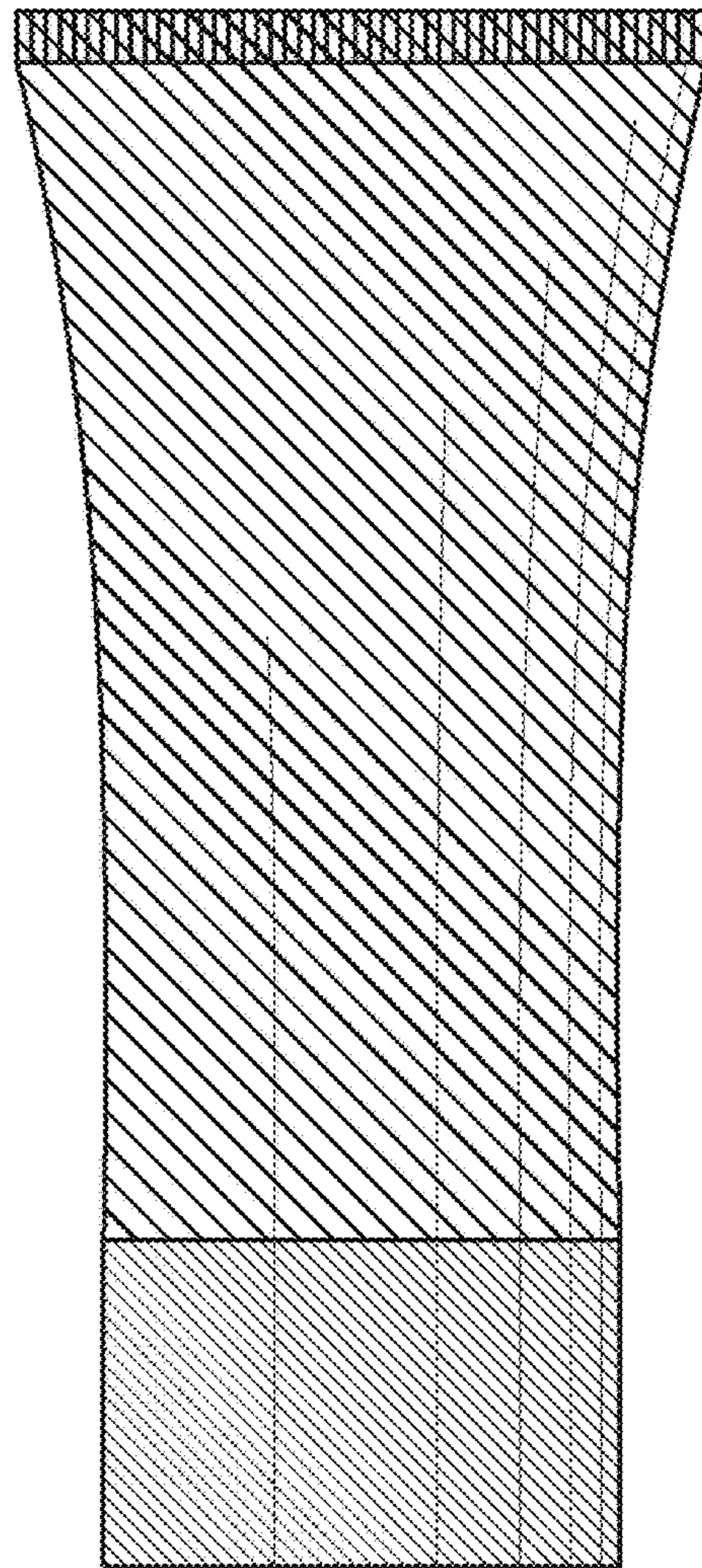

Fig. 14

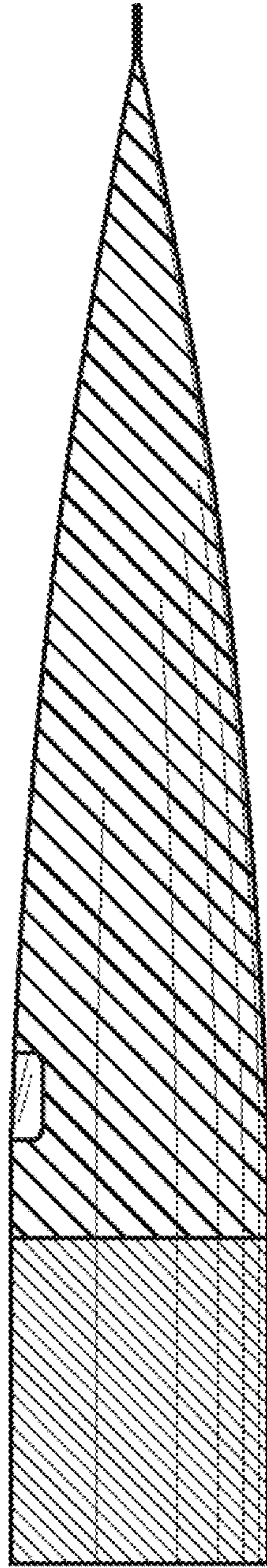

Fig. 15

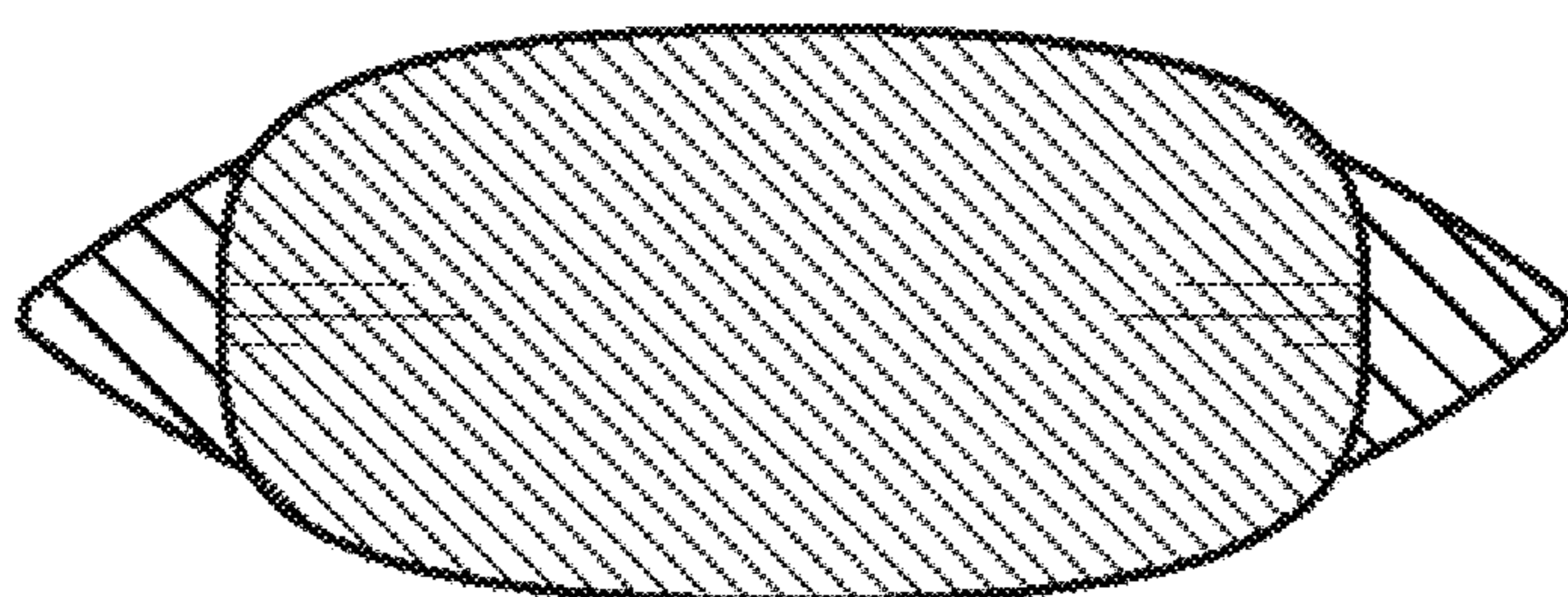

Fig. 16

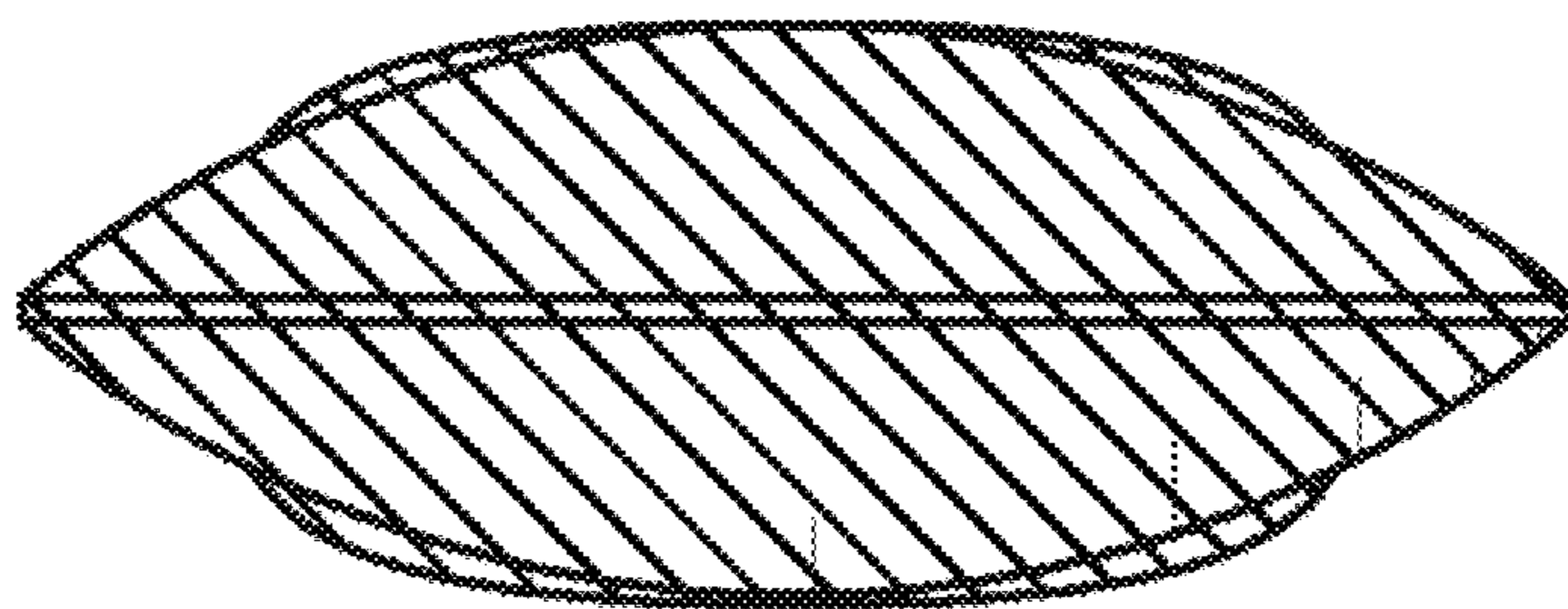

Fig. 17

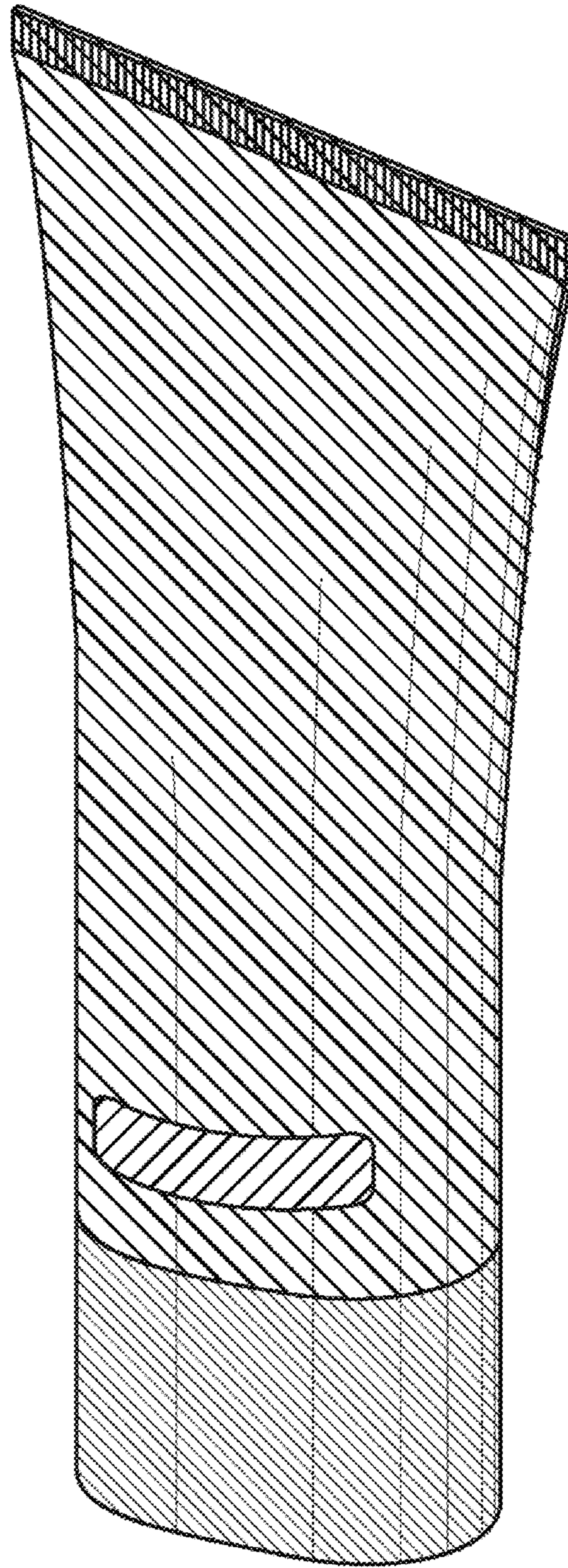

Fig. 18

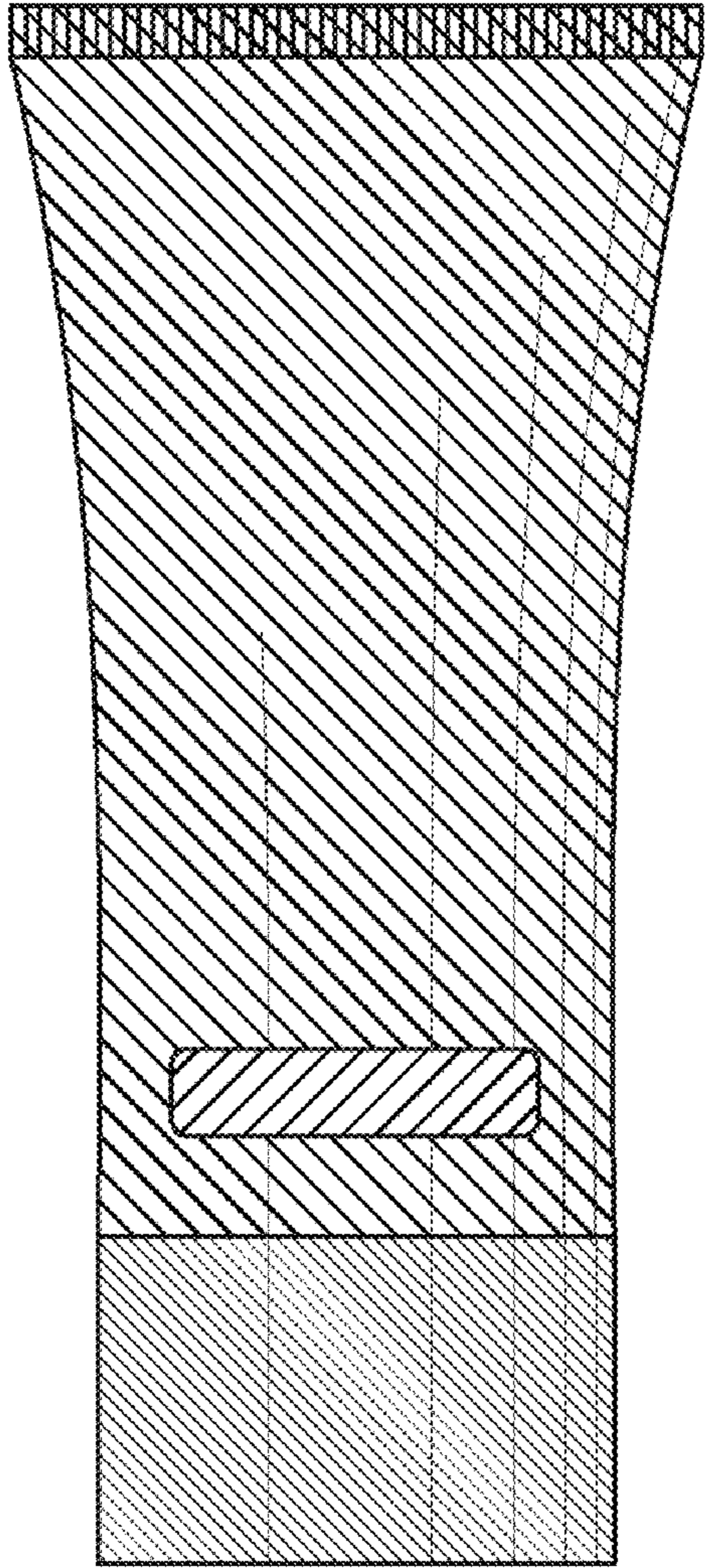

Fig. 19

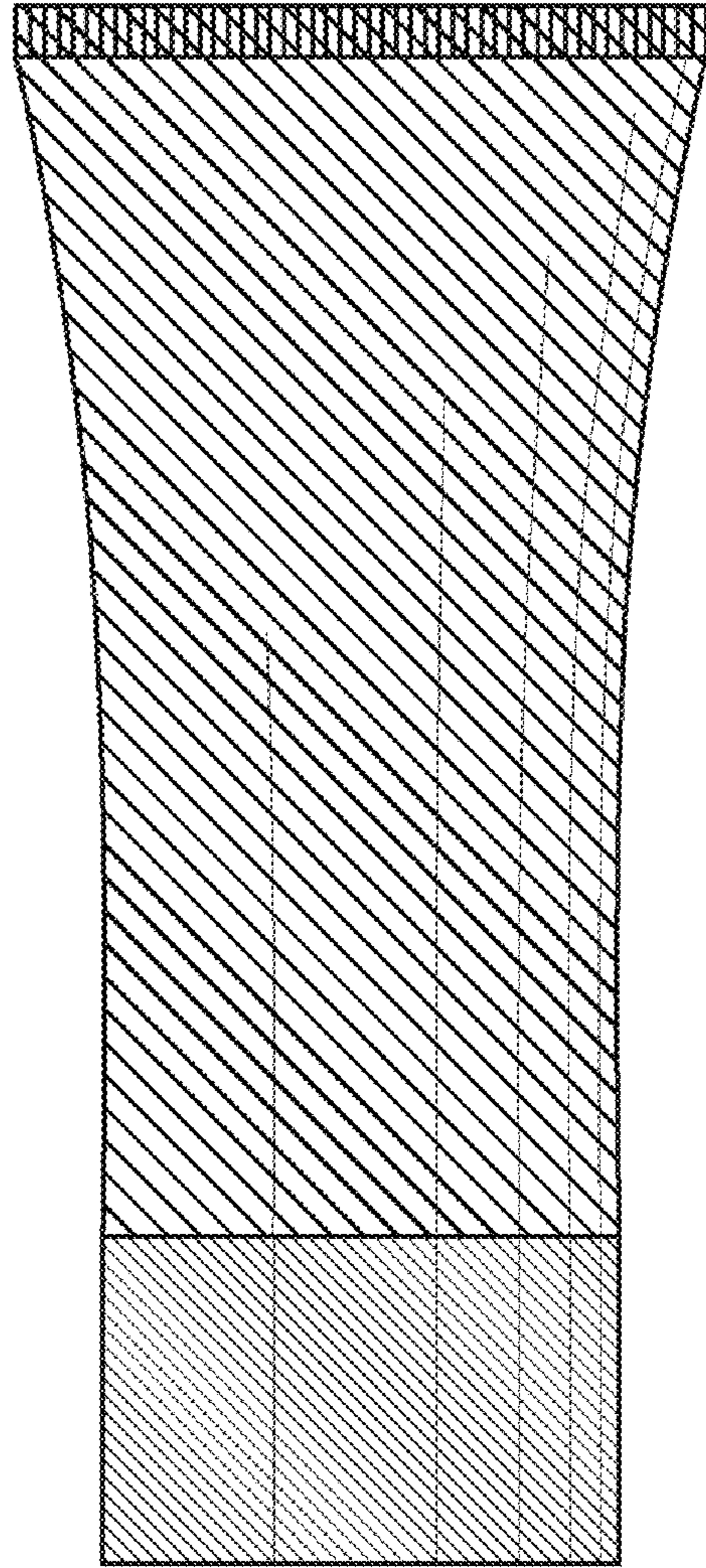

Fig. 20

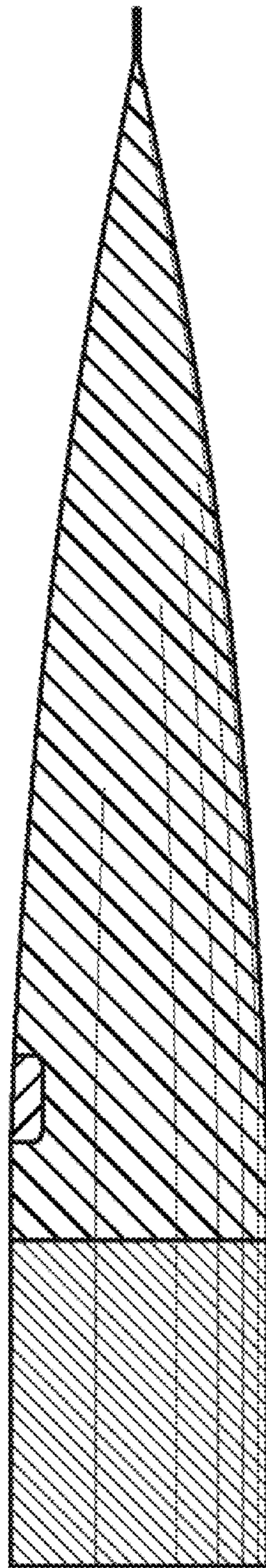

Fig. 21

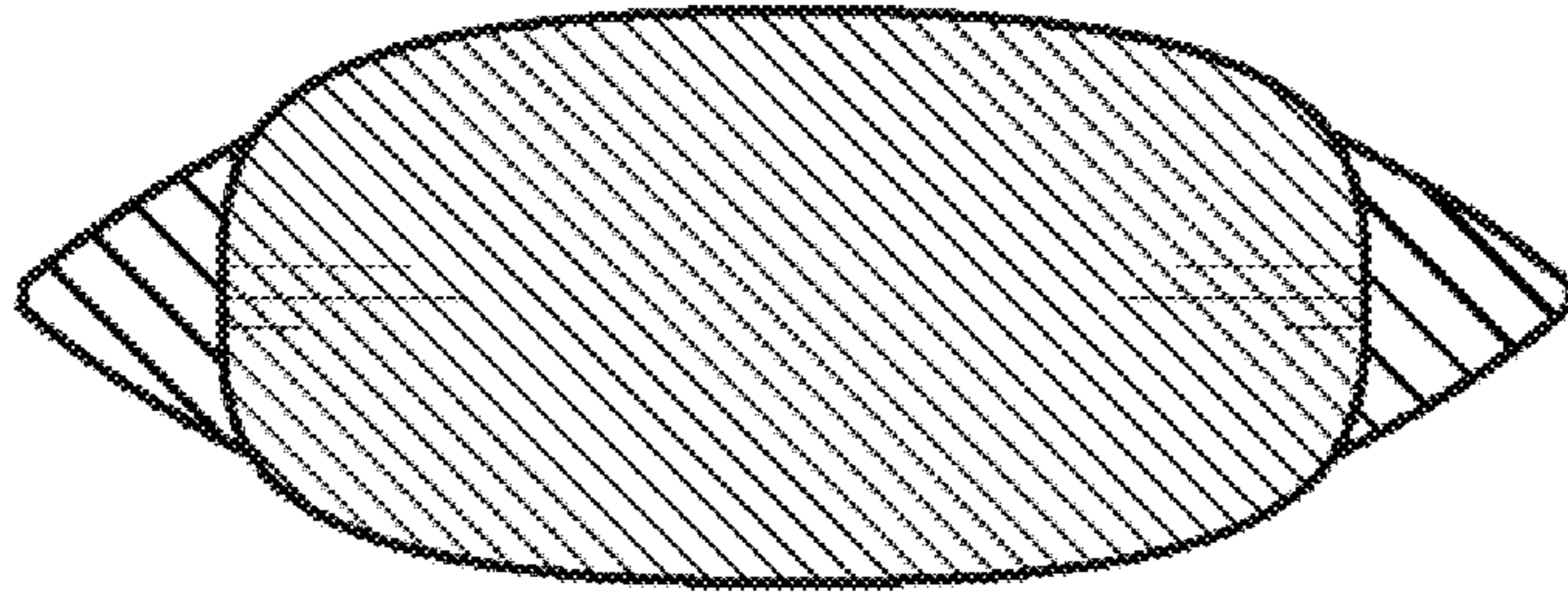

Fig. 22

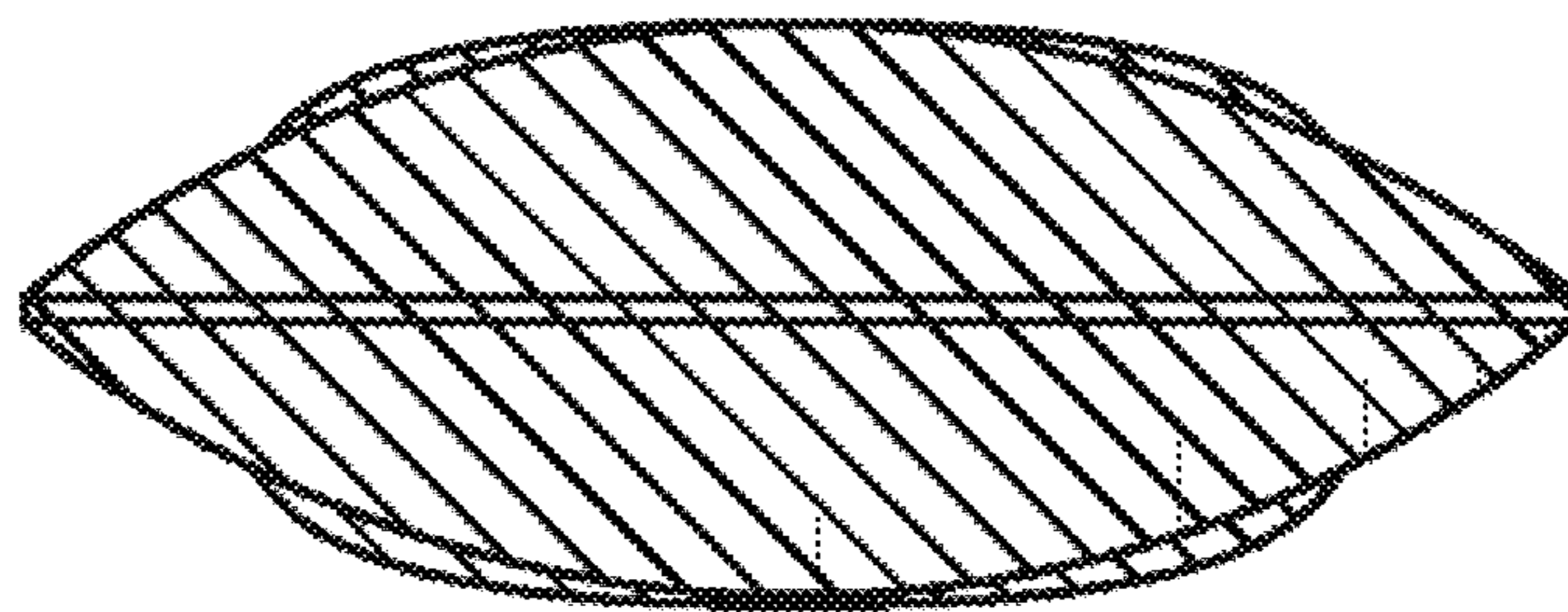

Fig. 23

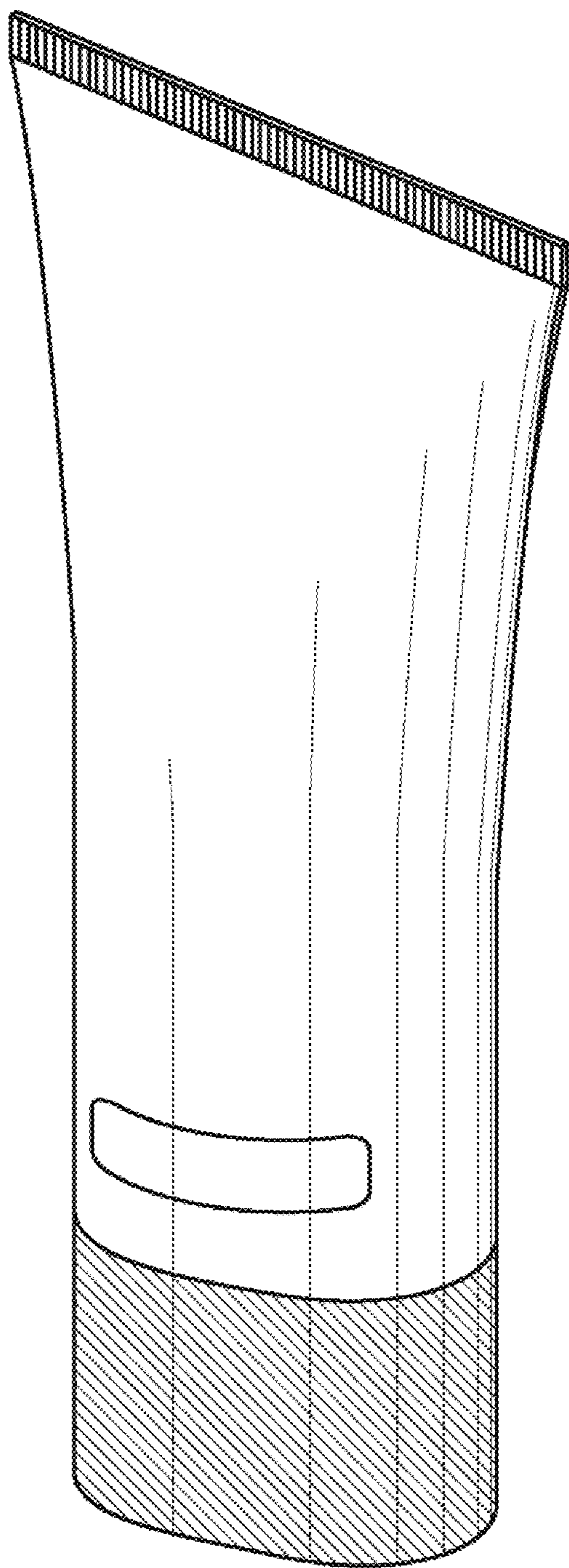

Fig. 24

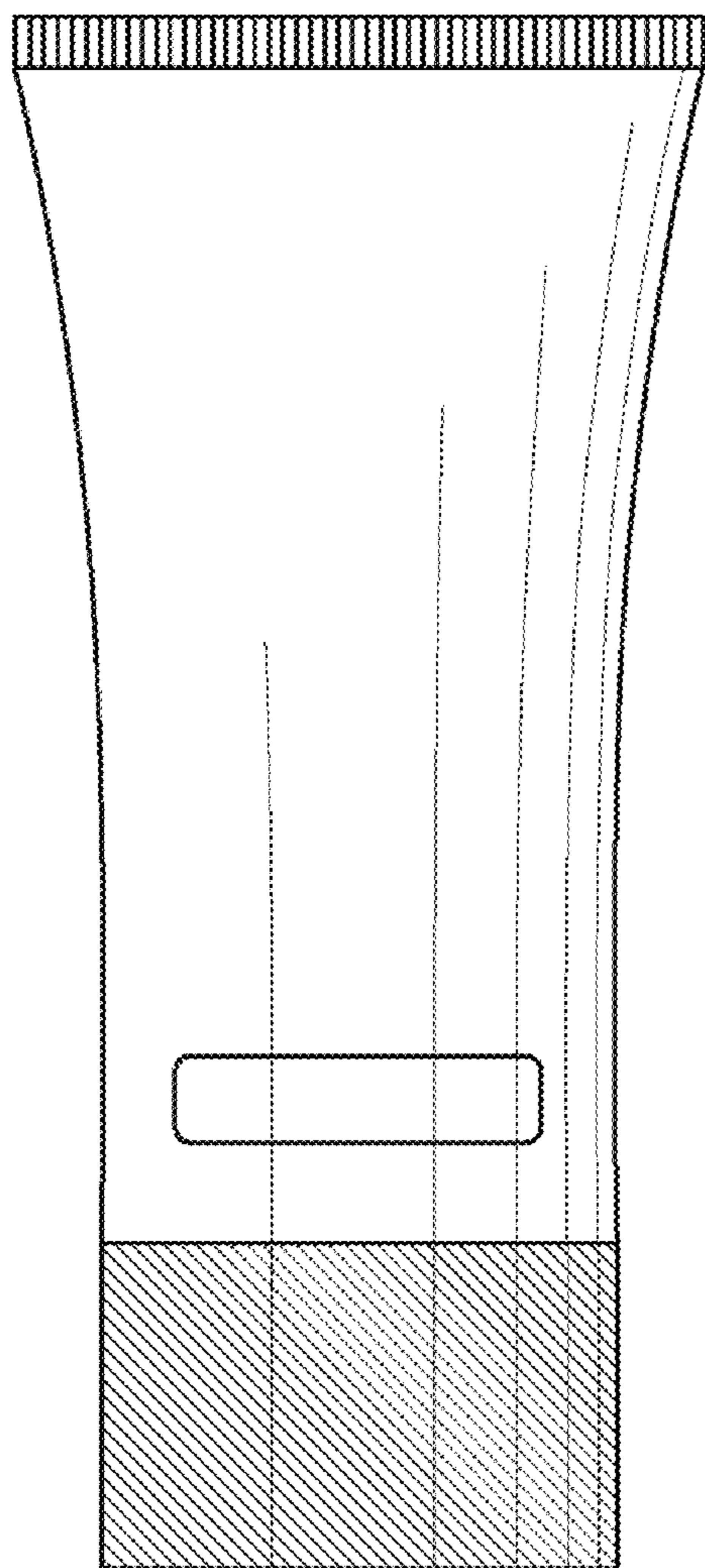

Fig. 25

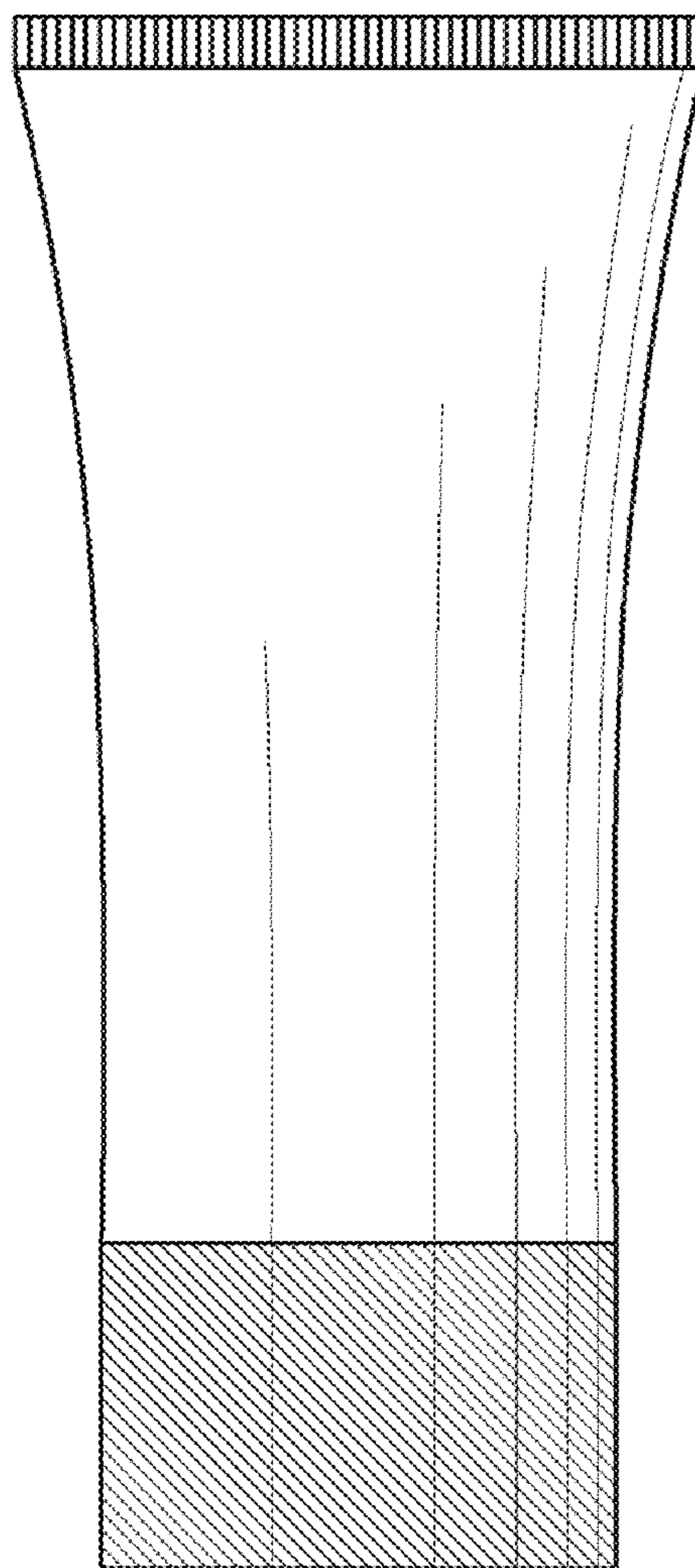

Fig. 26

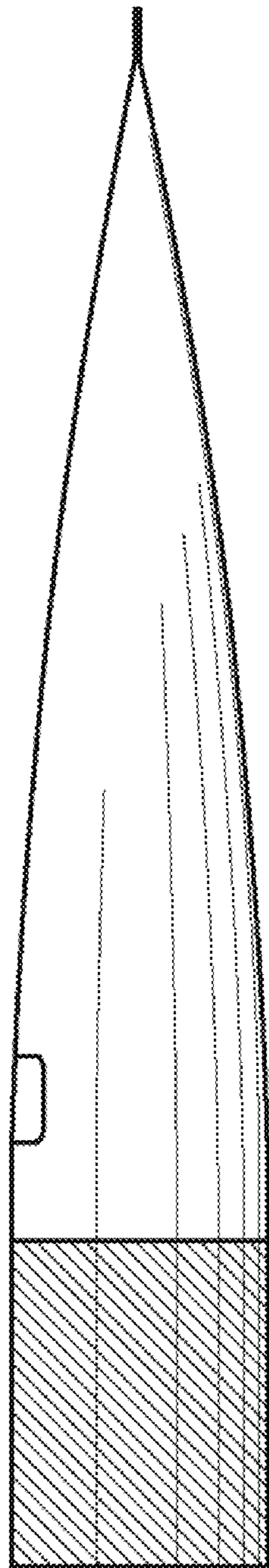

Fig. 27

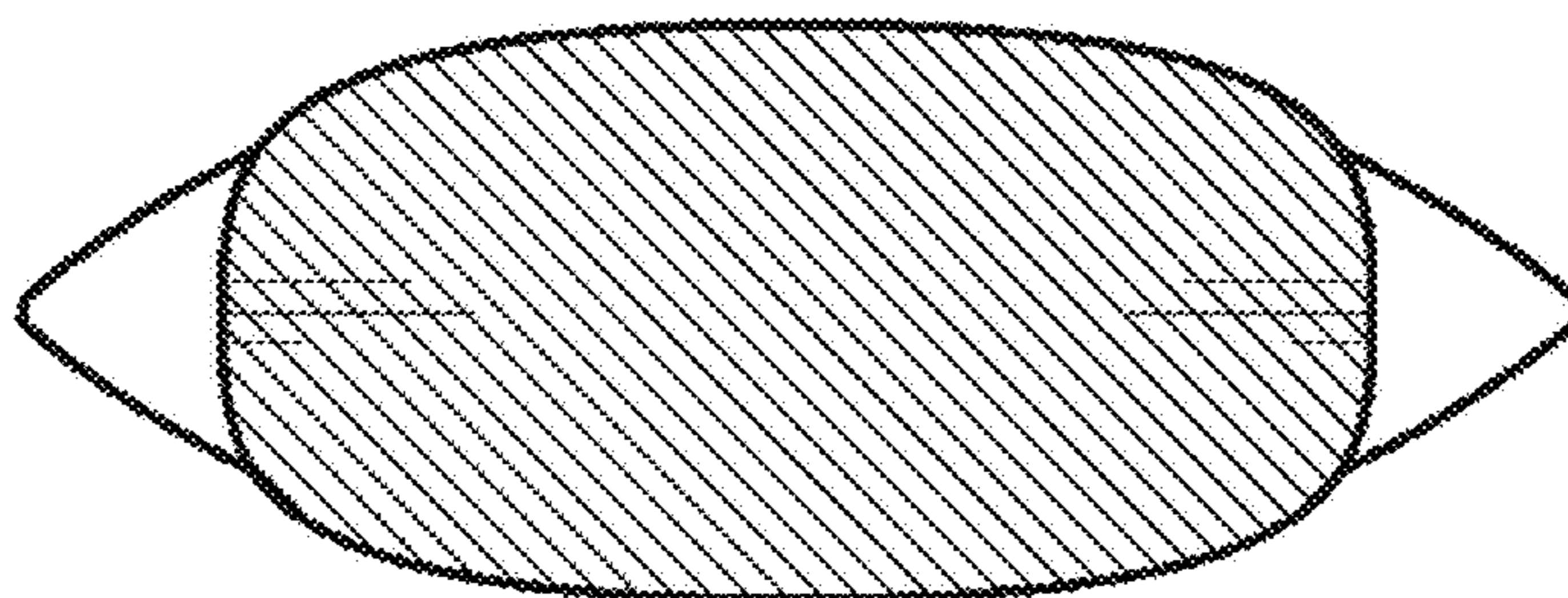

Fig. 28

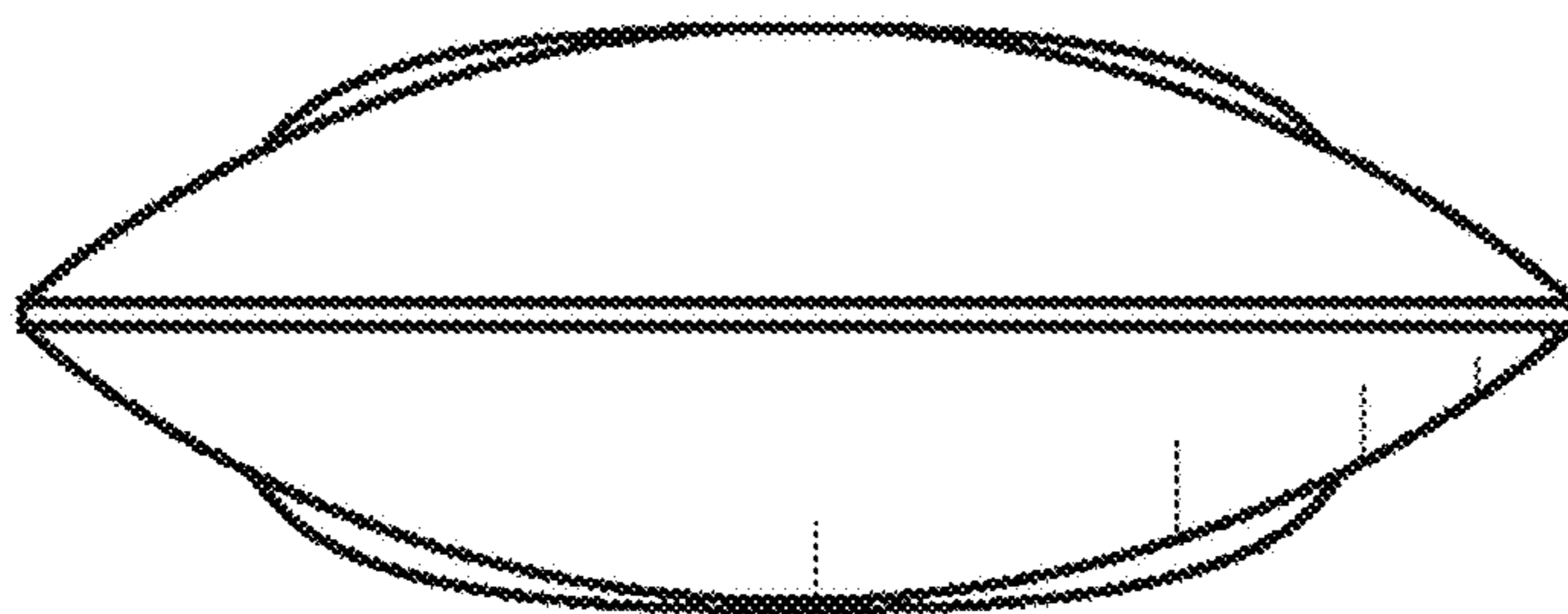

Fig. 29