



US00D649018S

(12) **United States Design Patent**
Kope

(10) **Patent No.:** **US D649,018 S**

(45) **Date of Patent:** **** Nov. 22, 2011**

(54) **LOCKING SWIVEL HOOK**

(75) Inventor: **Tyler R. M. Kope**, Seattle, WA (US)

(73) Assignee: **Black Rapid, Inc.**, Seattle, WA (US)

(**) Term: **14 Years**

(21) Appl. No.: **29/361,125**

(22) Filed: **May 5, 2010**

(51) **LOC (9) Cl.** **08-05**

(52) **U.S. Cl.** **D8/367**

(58) **Field of Classification Search** D8/367,
D8/323, 382, 356, 354, 372, 1; D12/115,
D12/317; D3/328, 207; 63/8, 7, 12, 15,
63/1.14; D6/323; 248/301-304, 175, 63;
70/59; 402/35; 114/218, 114; 24/598.1,
24/599.6, 588.1, 592.11, 452, 601, 601.5,
24/599.9, 129 R, 600.9; 294/137, 158, 82.19;
410/101; 182/3; D11/210; D9/752; D19/32
See application file for complete search history.

(56) **References Cited**

U.S. PATENT DOCUMENTS

D337,935 S * 8/1993 Hawley D8/367
5,878,834 A * 3/1999 Brainerd et al. 182/3
D434,971 S 12/2000 Cheng

(Continued)

FOREIGN PATENT DOCUMENTS

CN 452348 8/2001

(Continued)

Primary Examiner — Cynthia Underwood

(74) *Attorney, Agent, or Firm* — Davis Wright Tremaine
LLP; George C. Rondeau, Jr.

(57) **CLAIM**

The ornamental design for a locking swivel hook, as shown
and described.

DESCRIPTION

FIG. 1 is top left side perspective view of a locking swivel
hook showing my new design.

FIG. 2 is a left side elevational view thereof.
FIG. 3 is a right side elevational view thereof.
FIG. 4 is a front elevational view thereof.
FIG. 5 is a rear elevational view thereof.
FIG. 6 is a top plan view thereof.
FIG. 7 is a bottom plan view thereof.
FIG. 8 is a top left side perspective view of a second embodi-
ment thereof.
FIG. 9 is a left side elevational view thereof.
FIG. 10 is a right side elevational view thereof.
FIG. 11 is a front elevational view thereof.
FIG. 12 is a rear elevational view thereof.
FIG. 13 is a top plan view thereof.
FIG. 14 is a bottom plan view thereof.
FIG. 15 is a top left side perspective view of a third embodi-
ment thereof.
FIG. 16 is a left side elevational view thereof.
FIG. 17 is a right side elevational view thereof.
FIG. 18 is a front elevational view thereof.
FIG. 19 is a rear elevational view thereof.
FIG. 20 is a top plan view thereof.
FIG. 21 is a bottom plan view thereof.
FIG. 22 is a top left side perspective view of a fifth embodi-
ment thereof.
FIG. 23 is a left side elevational view thereof.
FIG. 24 is a right side elevational view thereof.
FIG. 25 is a front elevational view thereof.
FIG. 26 is a rear elevational view thereof.
FIG. 27 is a top plan view thereof.
FIG. 28 is a bottom plan view thereof.
FIG. 29 is a top left side perspective view of a sixth embodi-
ment thereof.
FIG. 30 is a left side elevational view thereof.
FIG. 31 is a right side elevational view thereof.
FIG. 32 is a front elevational view thereof.
FIG. 33 is a rear elevational view thereof.
FIG. 34 is a top plan view thereof.
FIG. 35 is a bottom plan view thereof.
FIG. 36 is a top left side perspective view of a seventh
embodiment thereof.
FIG. 37 is a left side elevational view thereof.
FIG. 38 is a right side elevational view thereof.
FIG. 39 is a front elevational view thereof.
FIG. 40 is a rear elevational view thereof.
FIG. 41 is a top plan view thereof; and,
FIG. 42 is a bottom plan view thereof.
The broken lines represent portions of the locking swivel
hook that form no part of the claim.

1 Claim, 18 Drawing Sheets

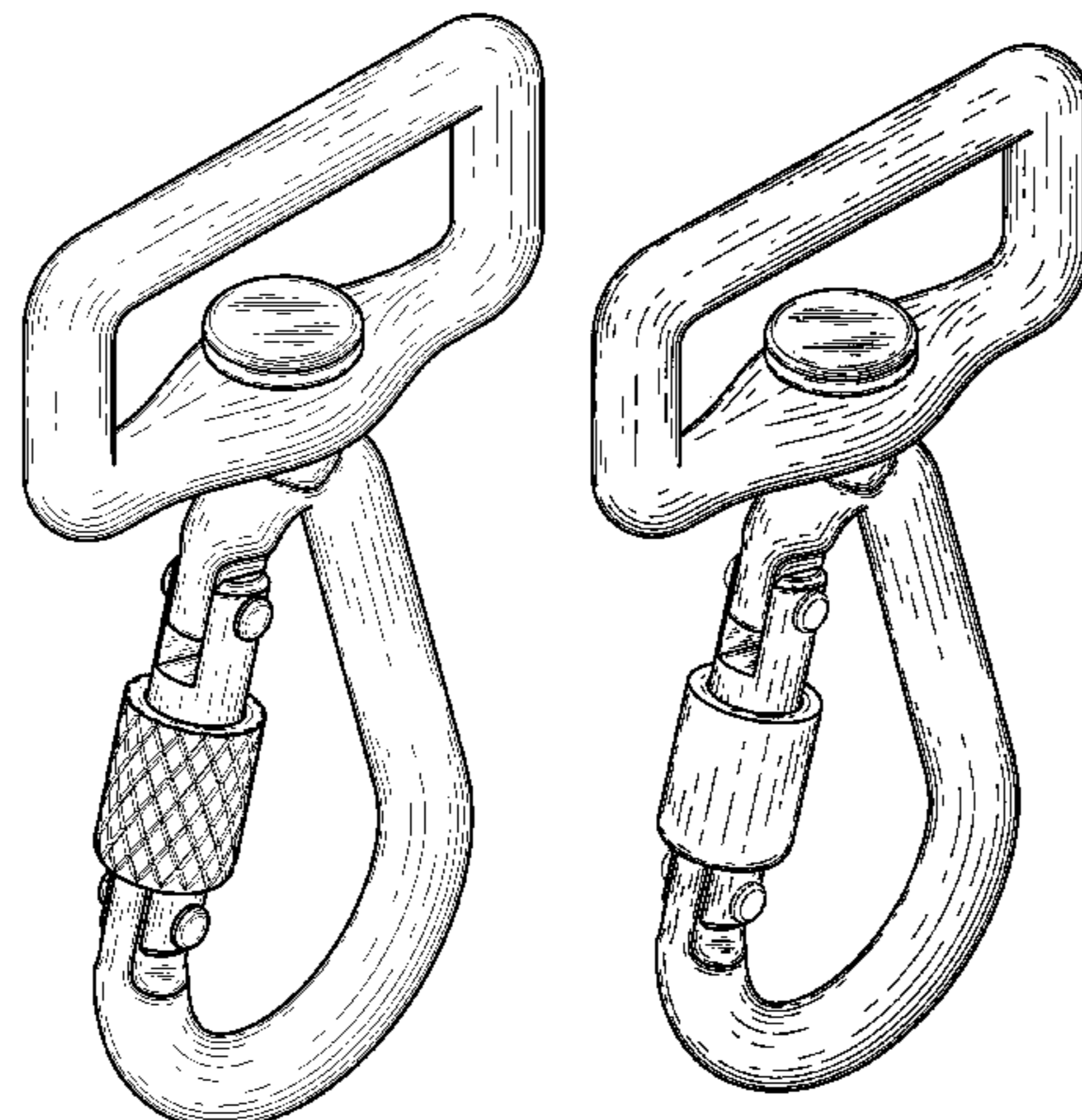

US D649,018 S

Page 2

U.S. PATENT DOCUMENTS

6,550,413 B2 * 4/2003 Fiorentino et al. 114/311
D496,251 S 9/2004 Buscart
D579,763 S * 11/2008 Uehara et al. D8/367
D631,331 S * 1/2011 Kelleghan D8/356
2006/0179784 A1 * 8/2006 Chen 52/698

FOREIGN PATENT DOCUMENTS

CN D122371 4/2008

* cited by examiner

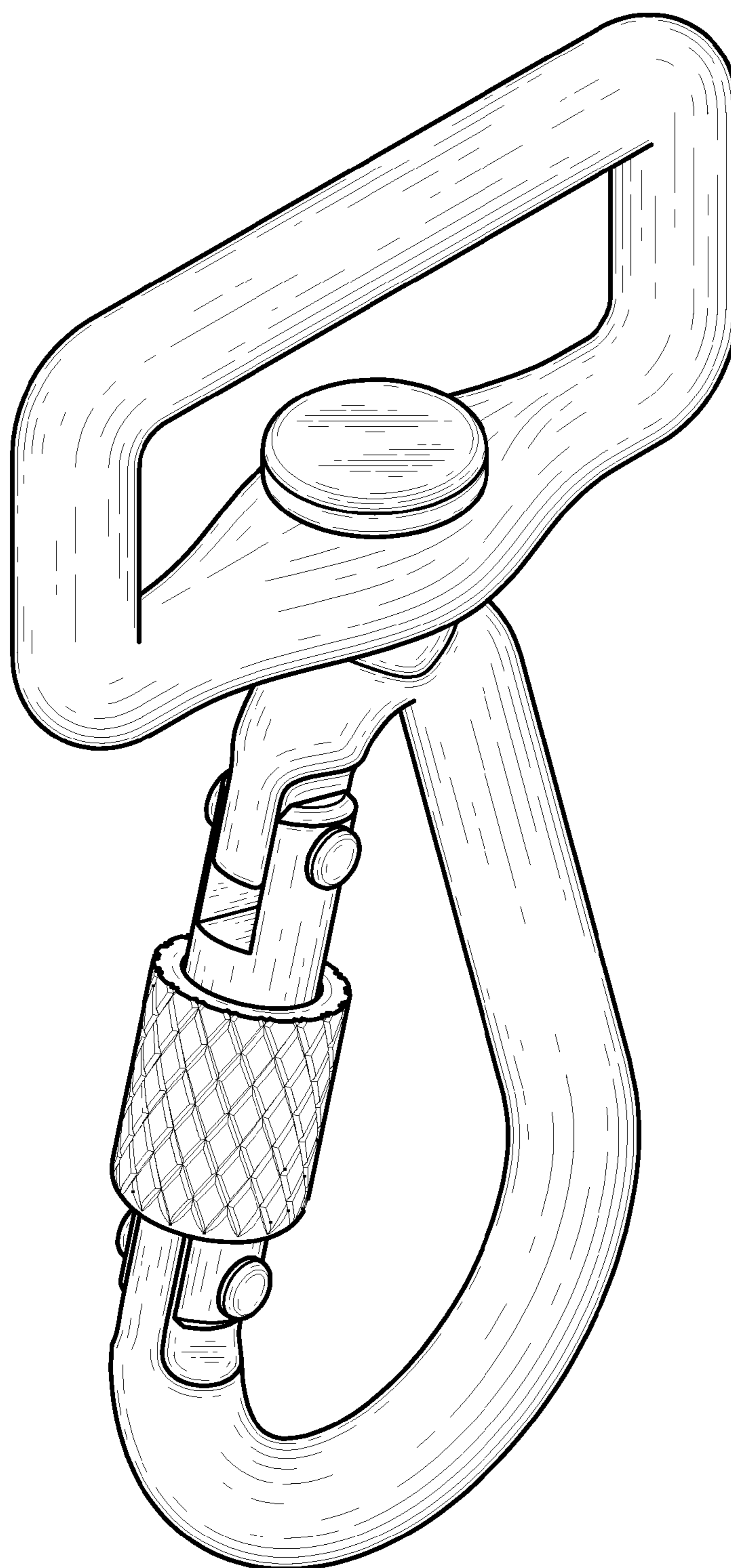

Fig. 1

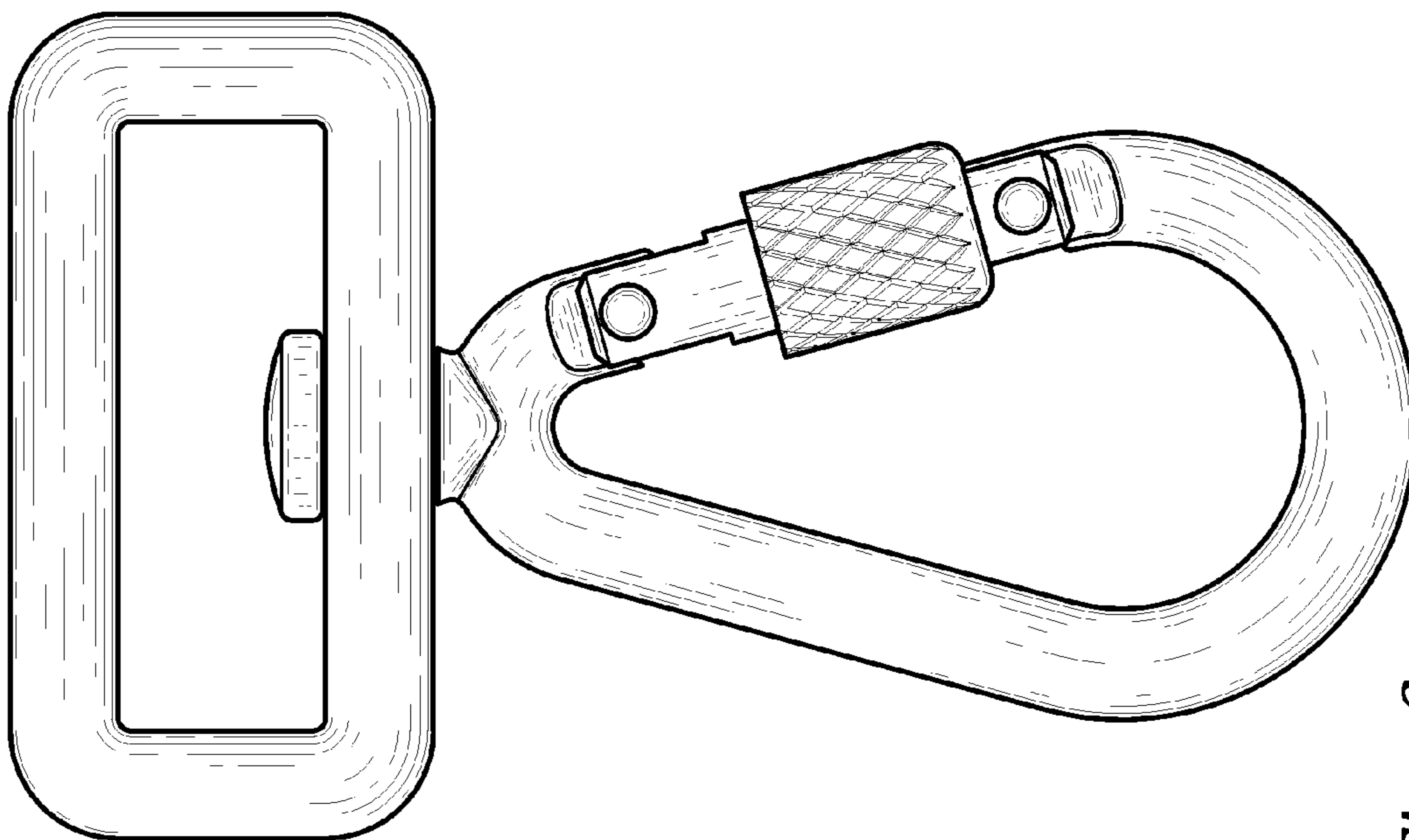

Fig. 3

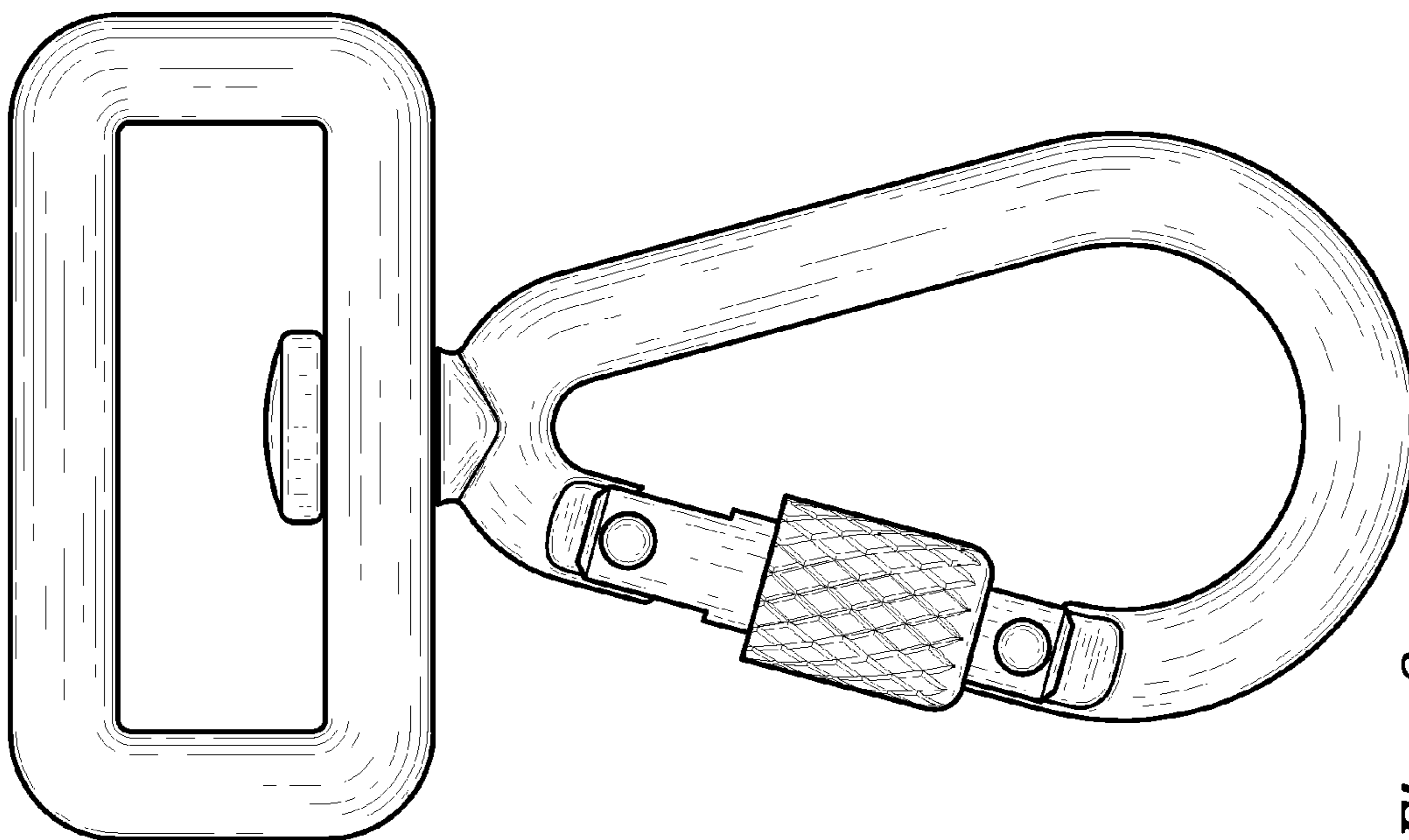

Fig. 2

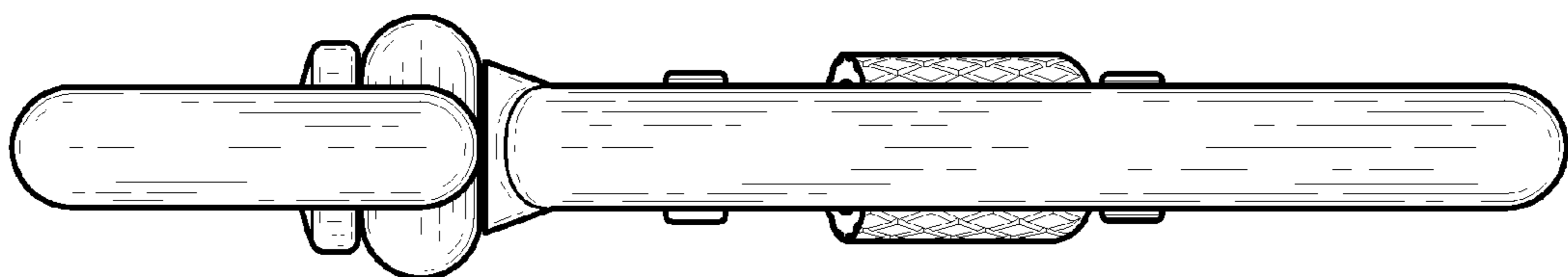

Fig. 4

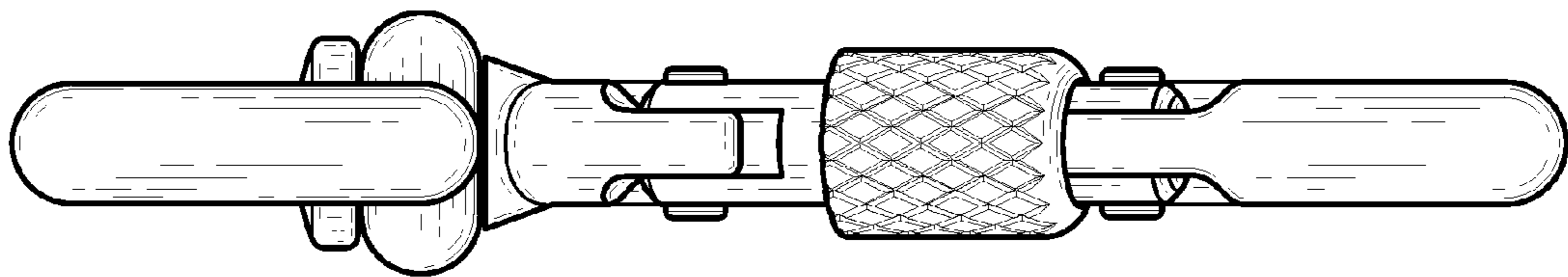

Fig. 5

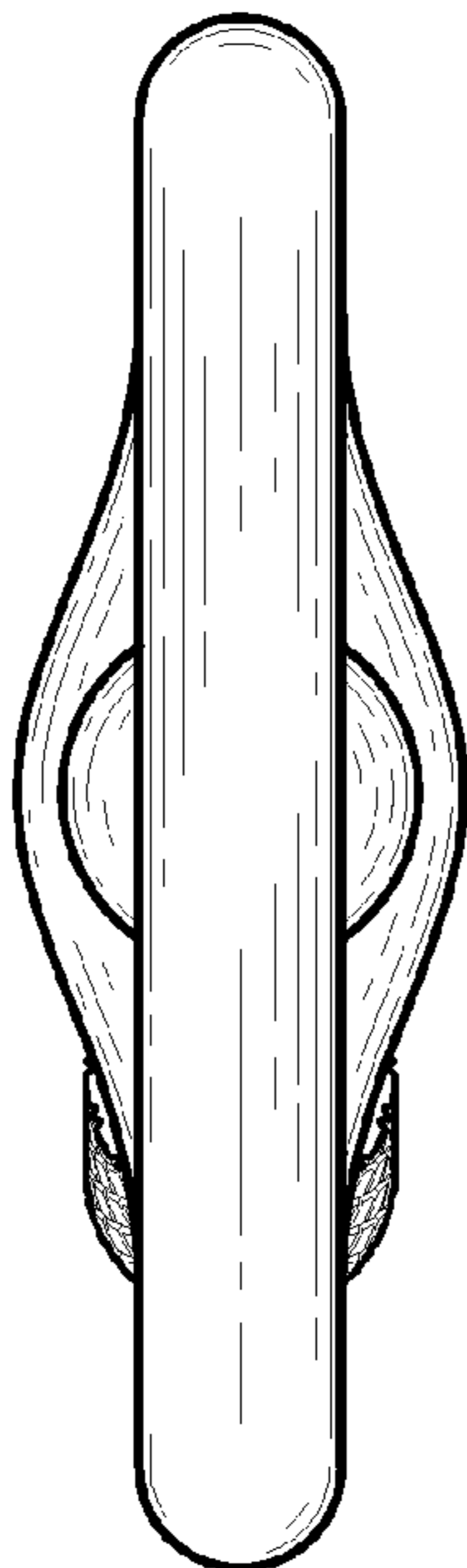

Fig. 6

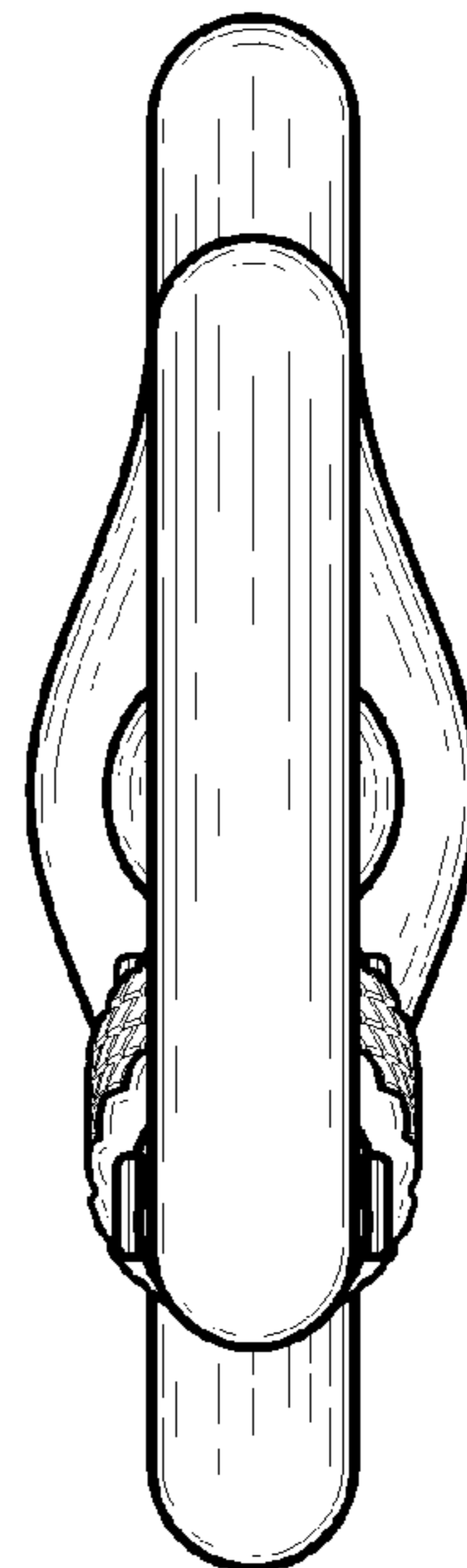

Fig. 7

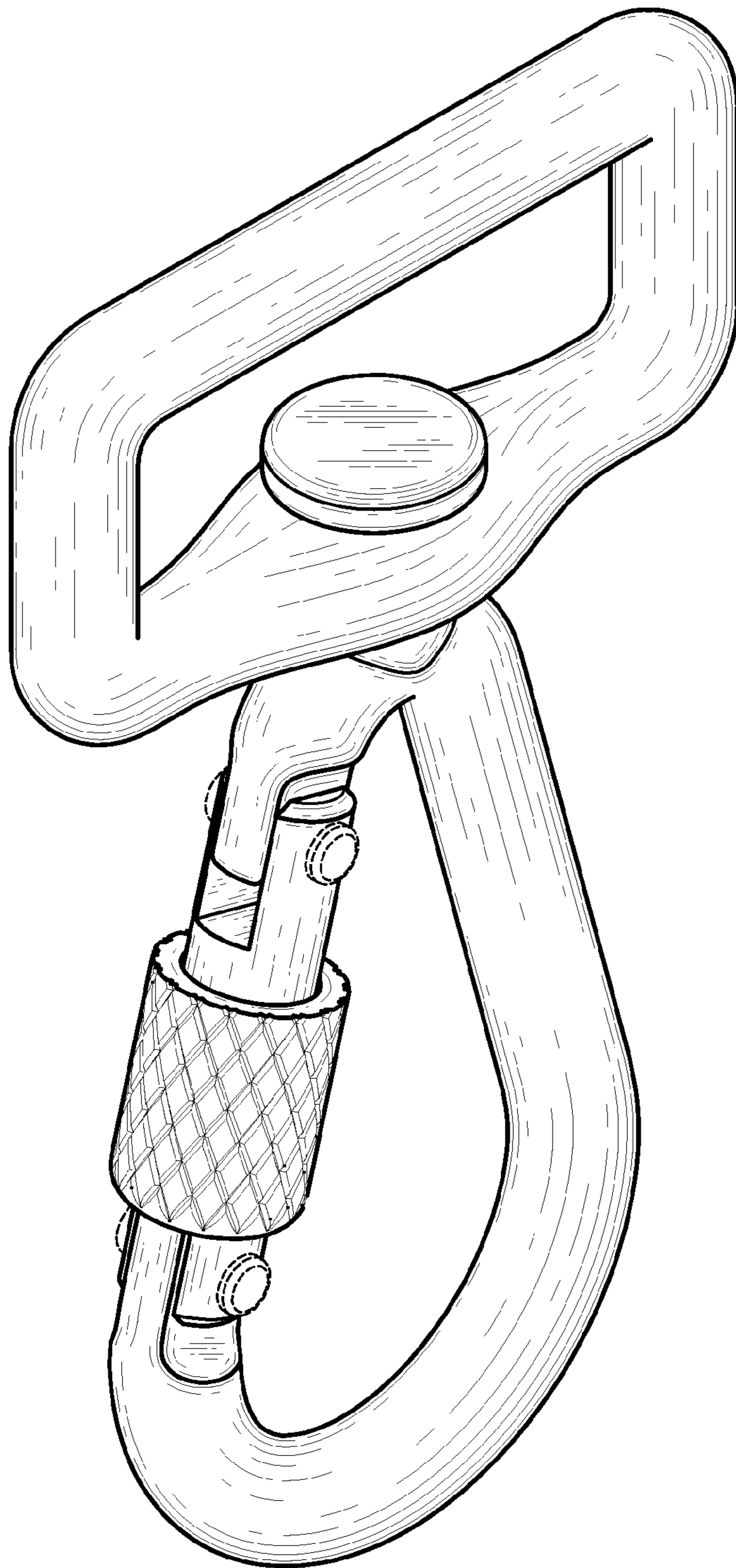

Fig. 8

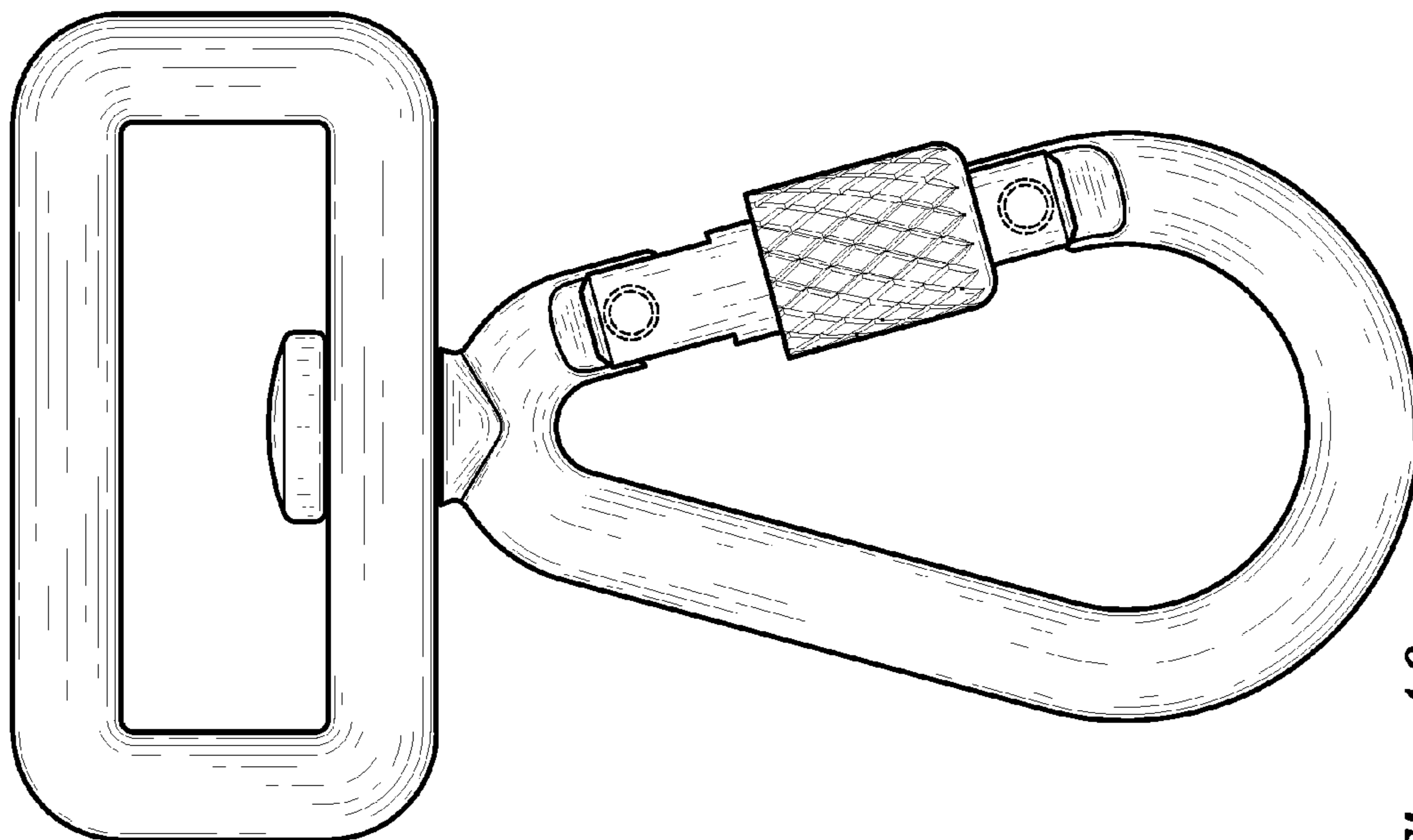

Fig. 10

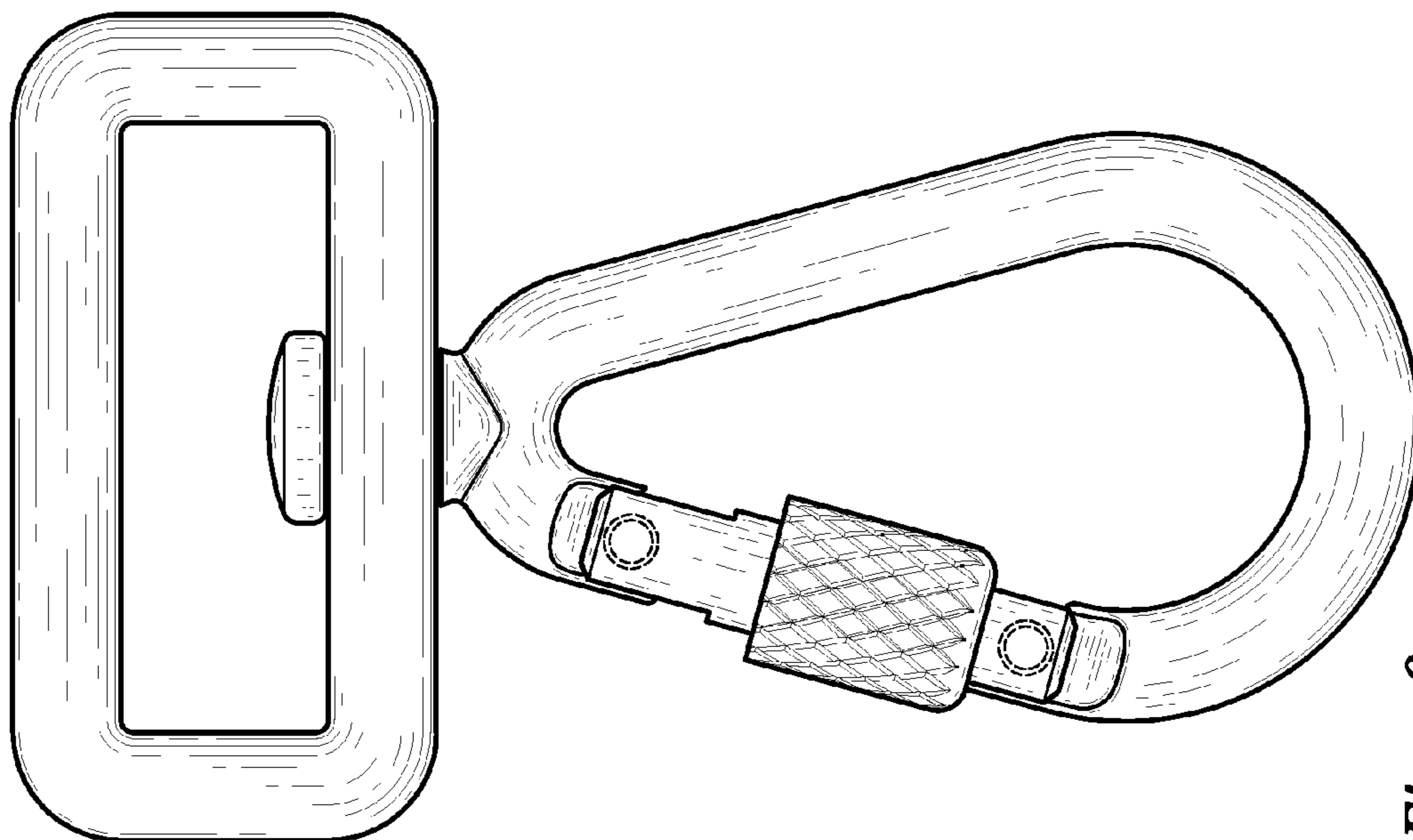

Fig. 9

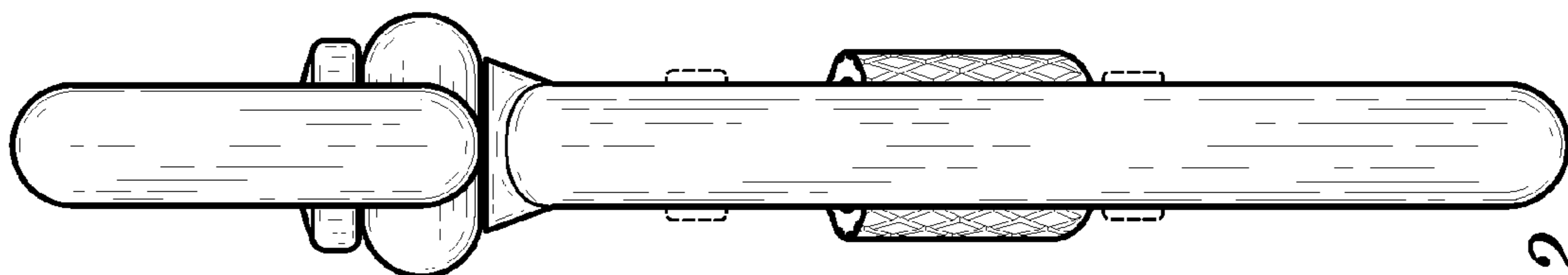

Fig. 11

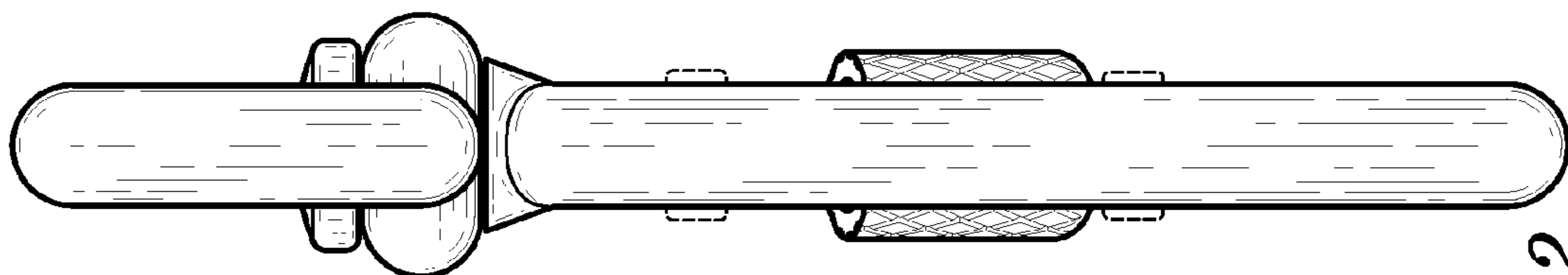

Fig. 12

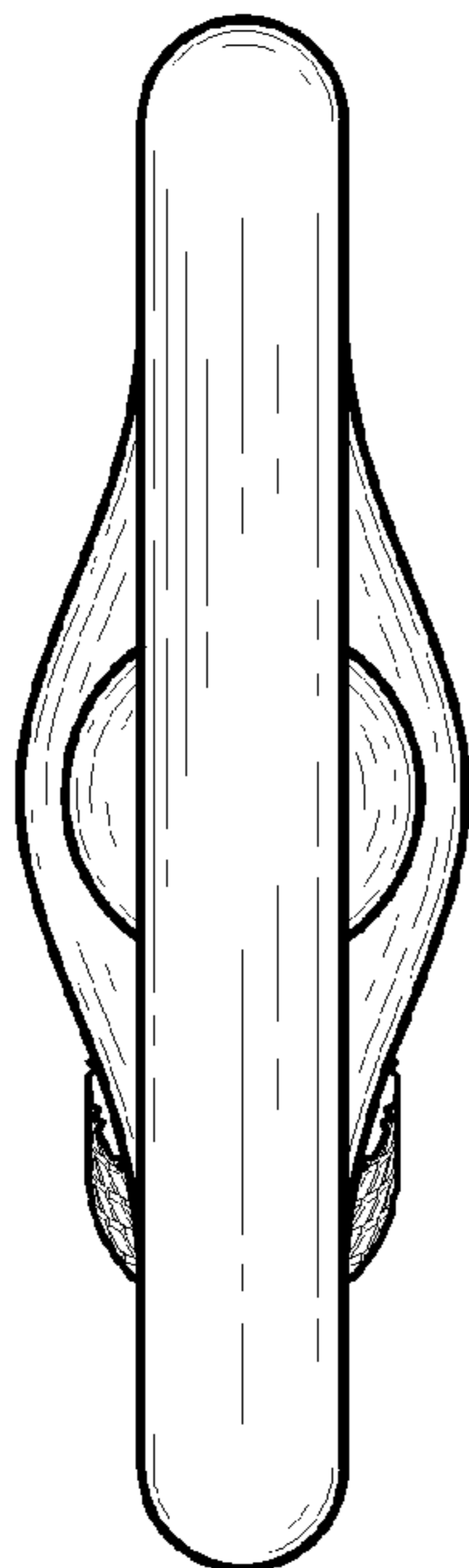

Fig. 13

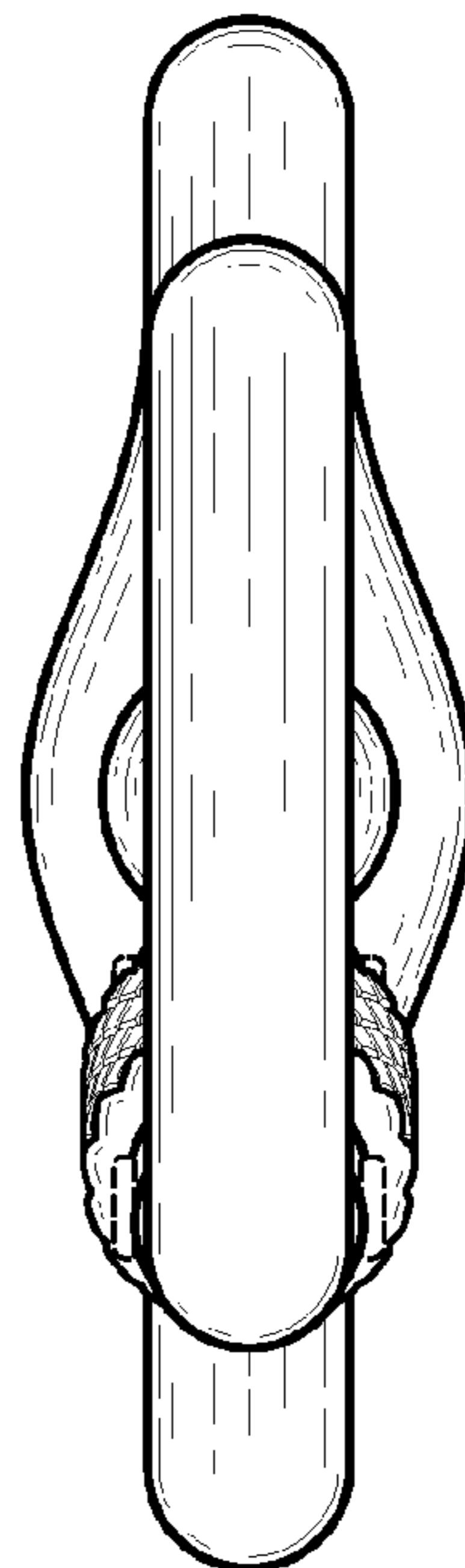

Fig. 14

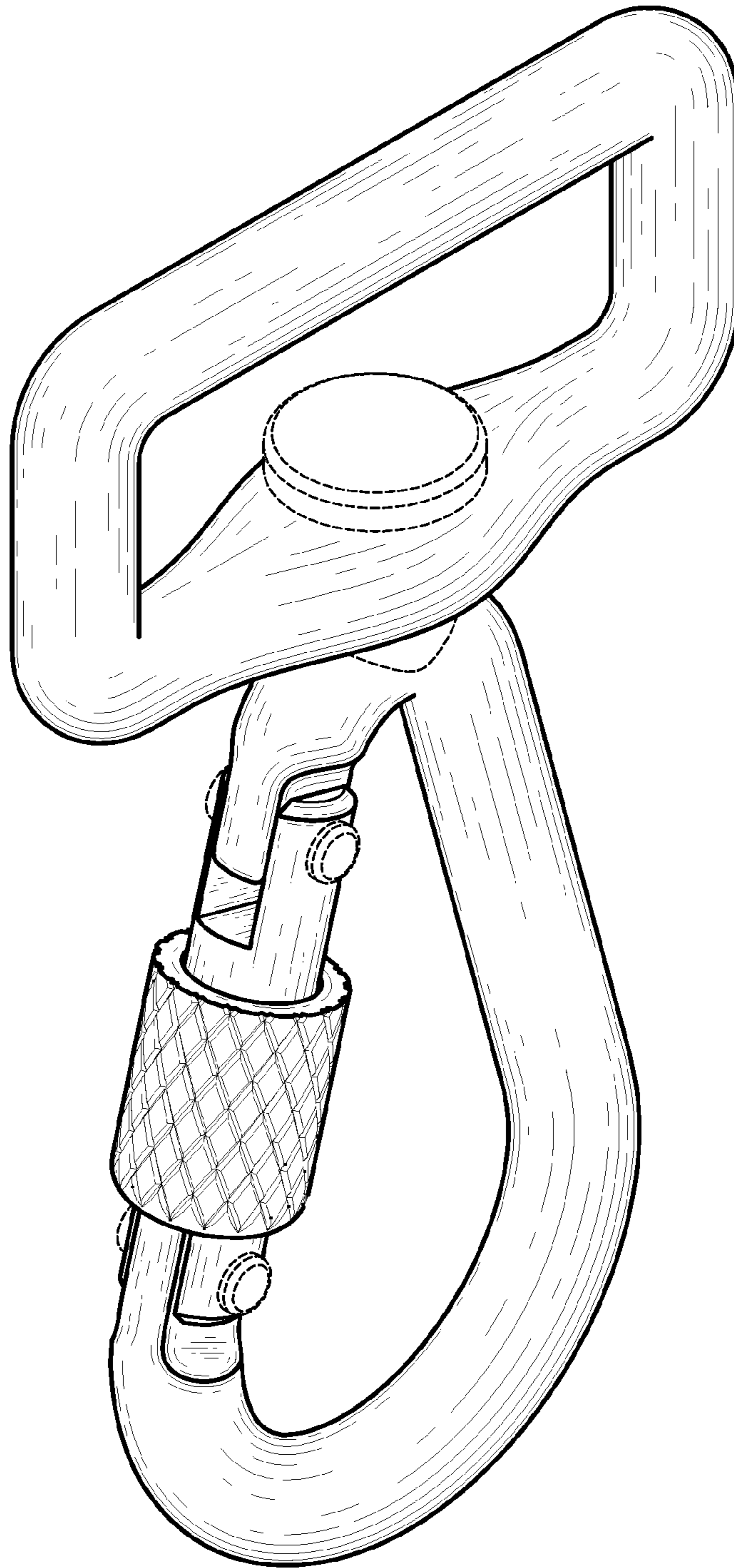

Fig. 15

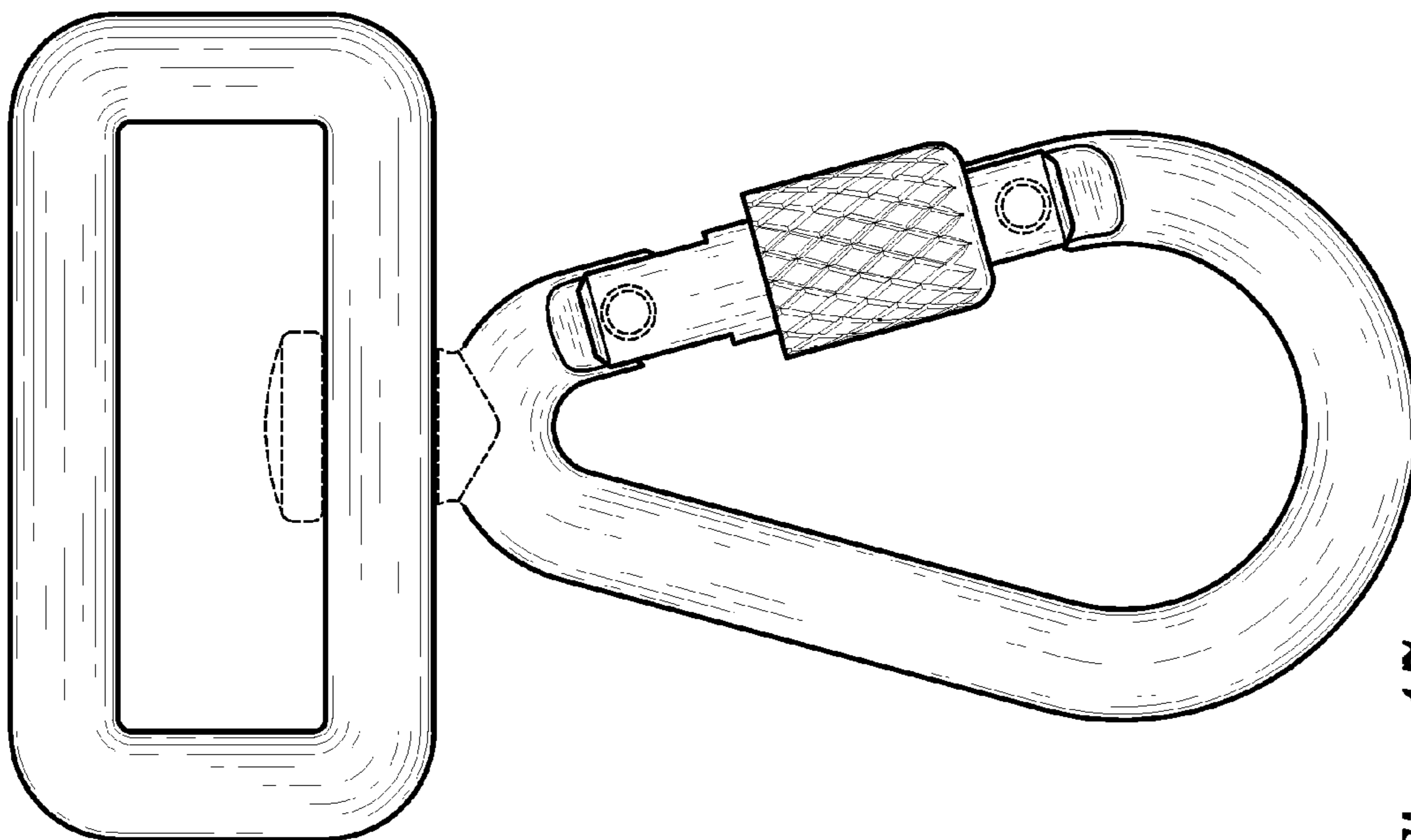

Fig. 16

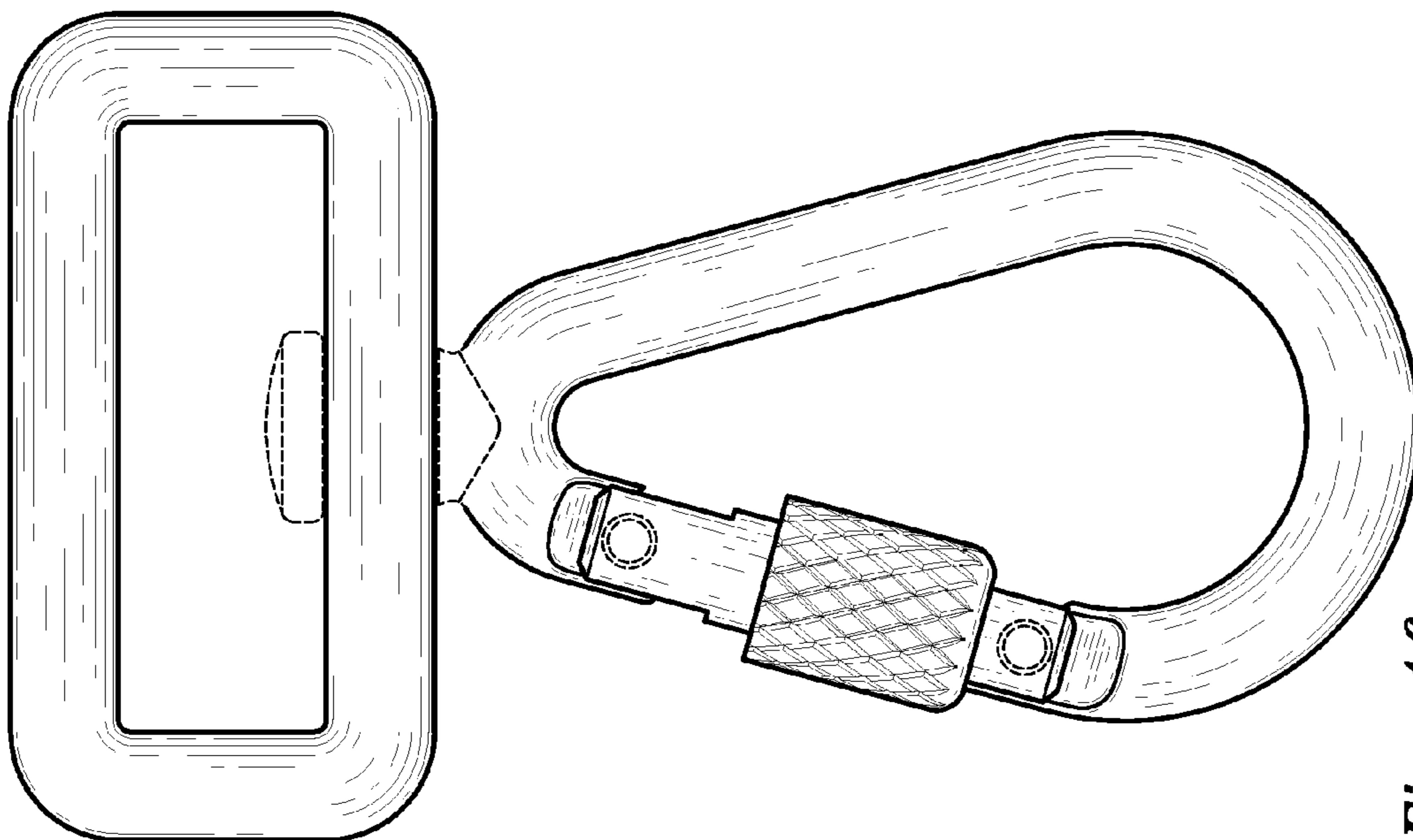

Fig. 17

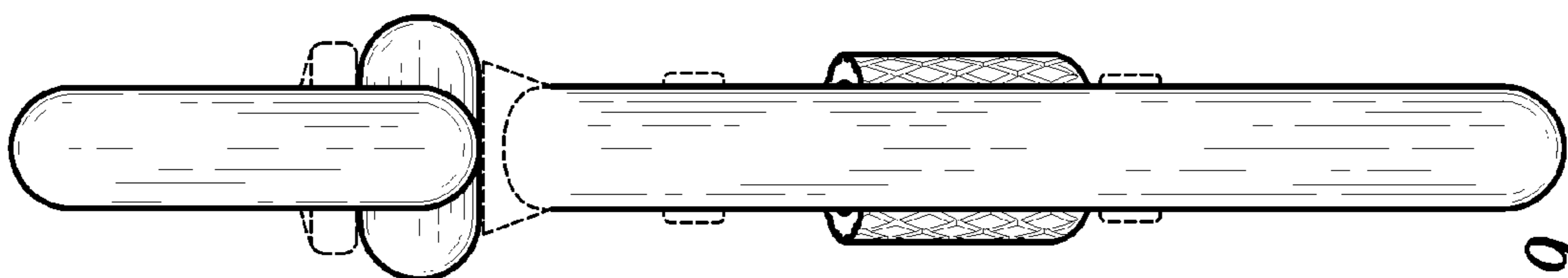

Fig. 18

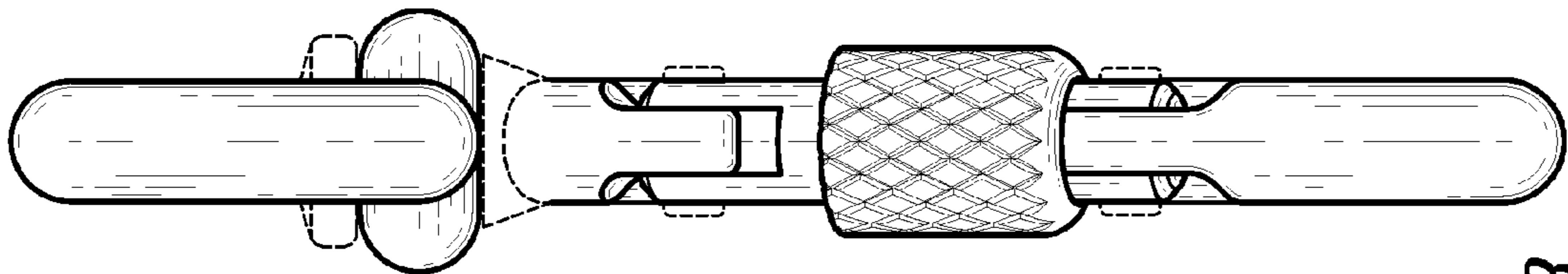

Fig. 19

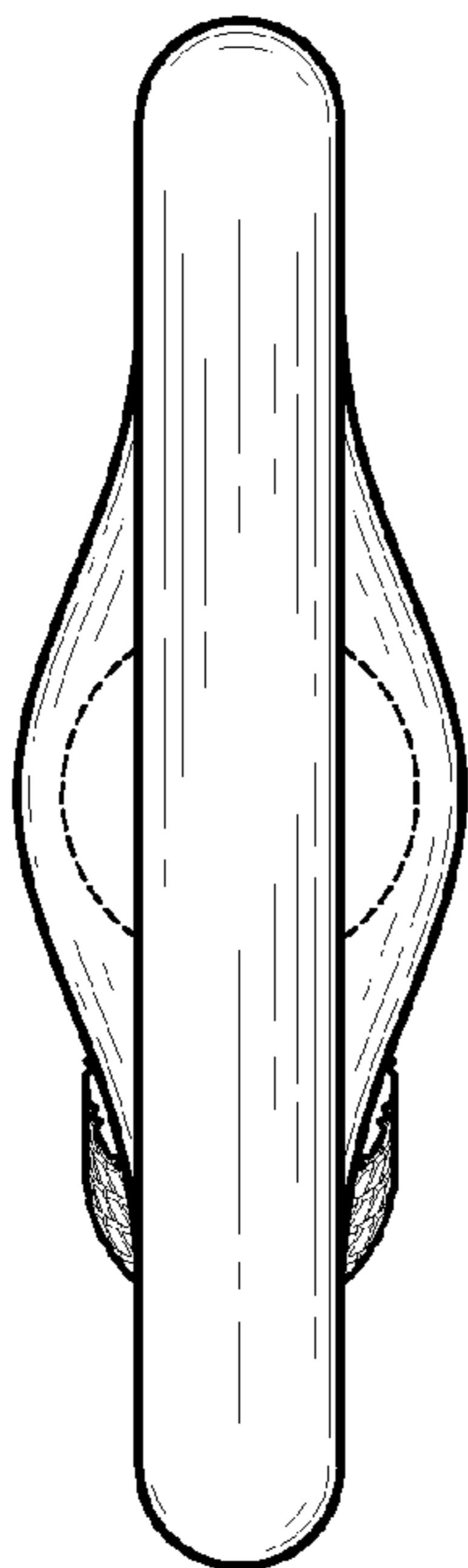

Fig. 20

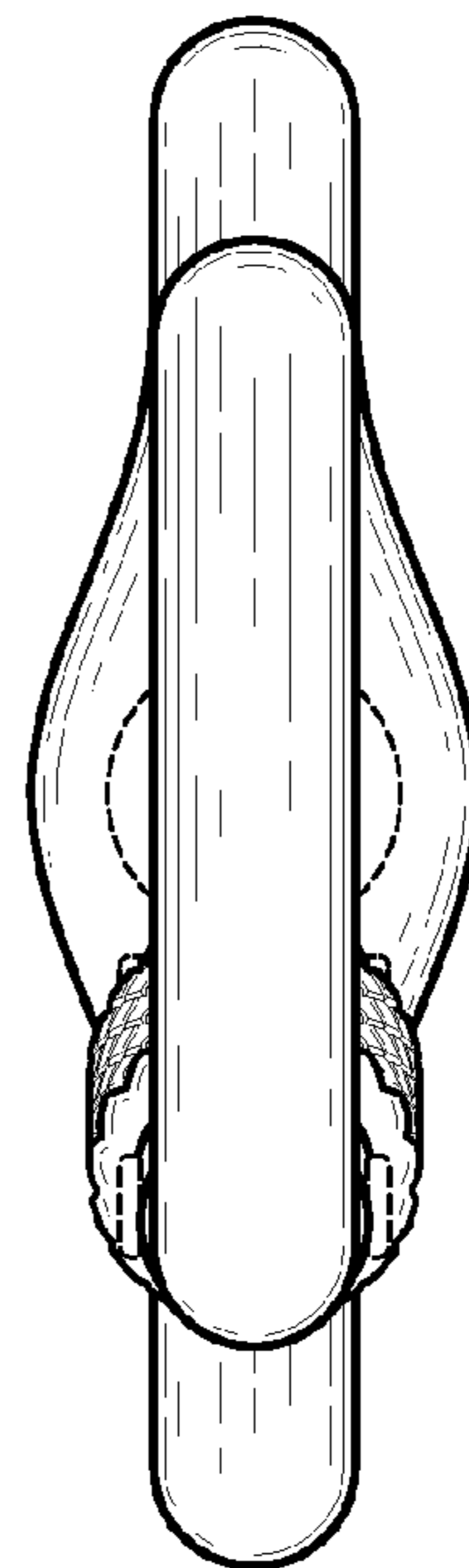

Fig. 21

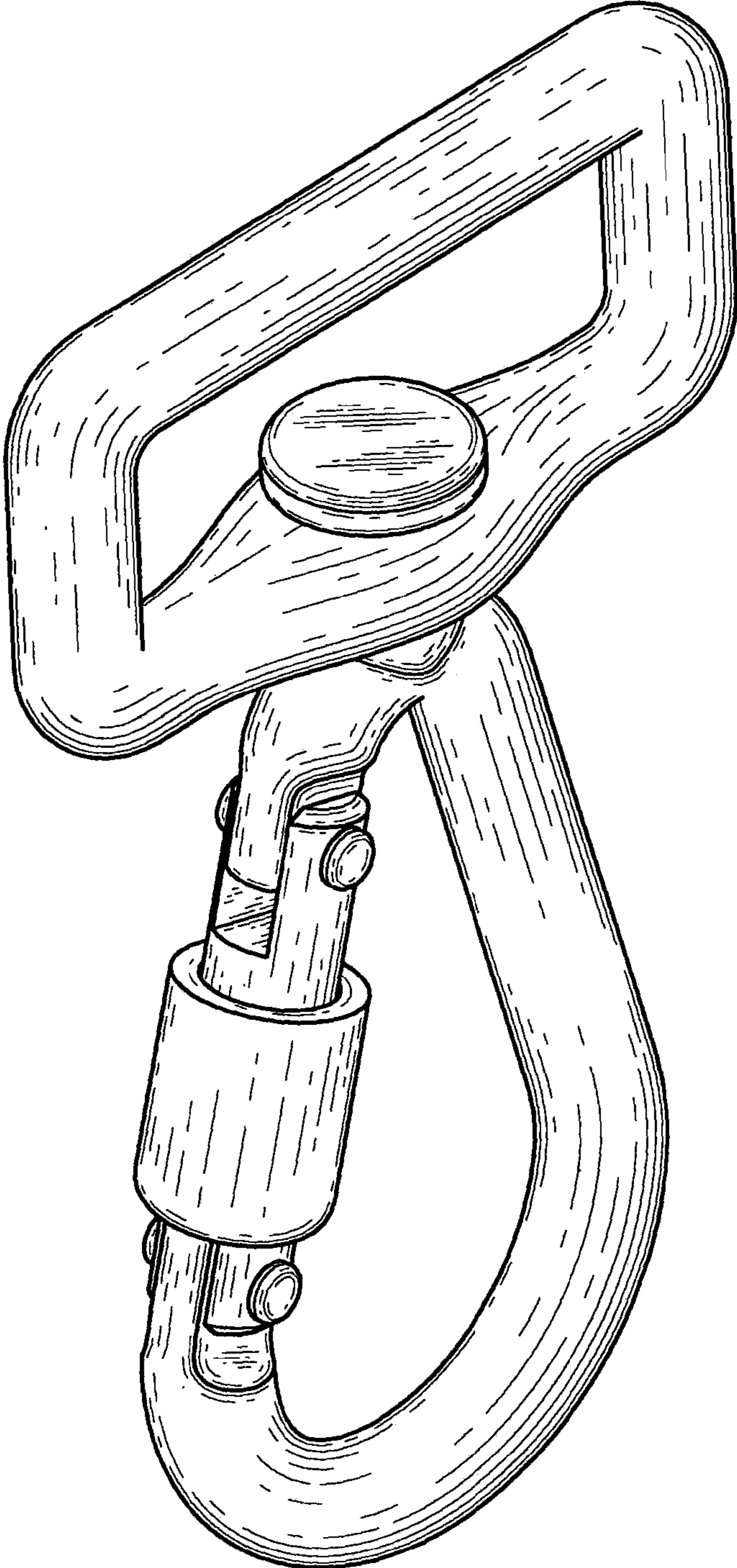

Fig. 22

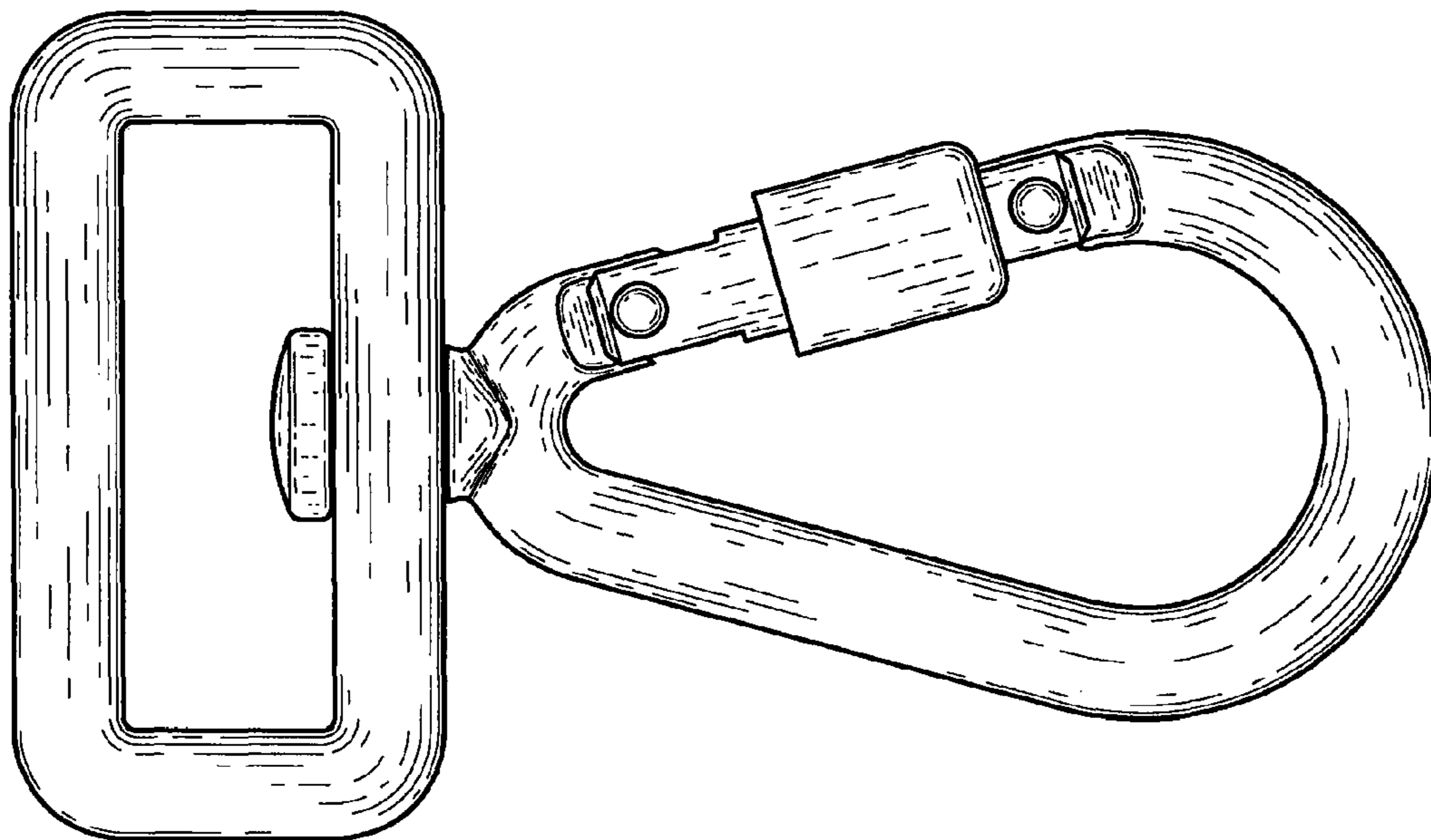

Fig. 24

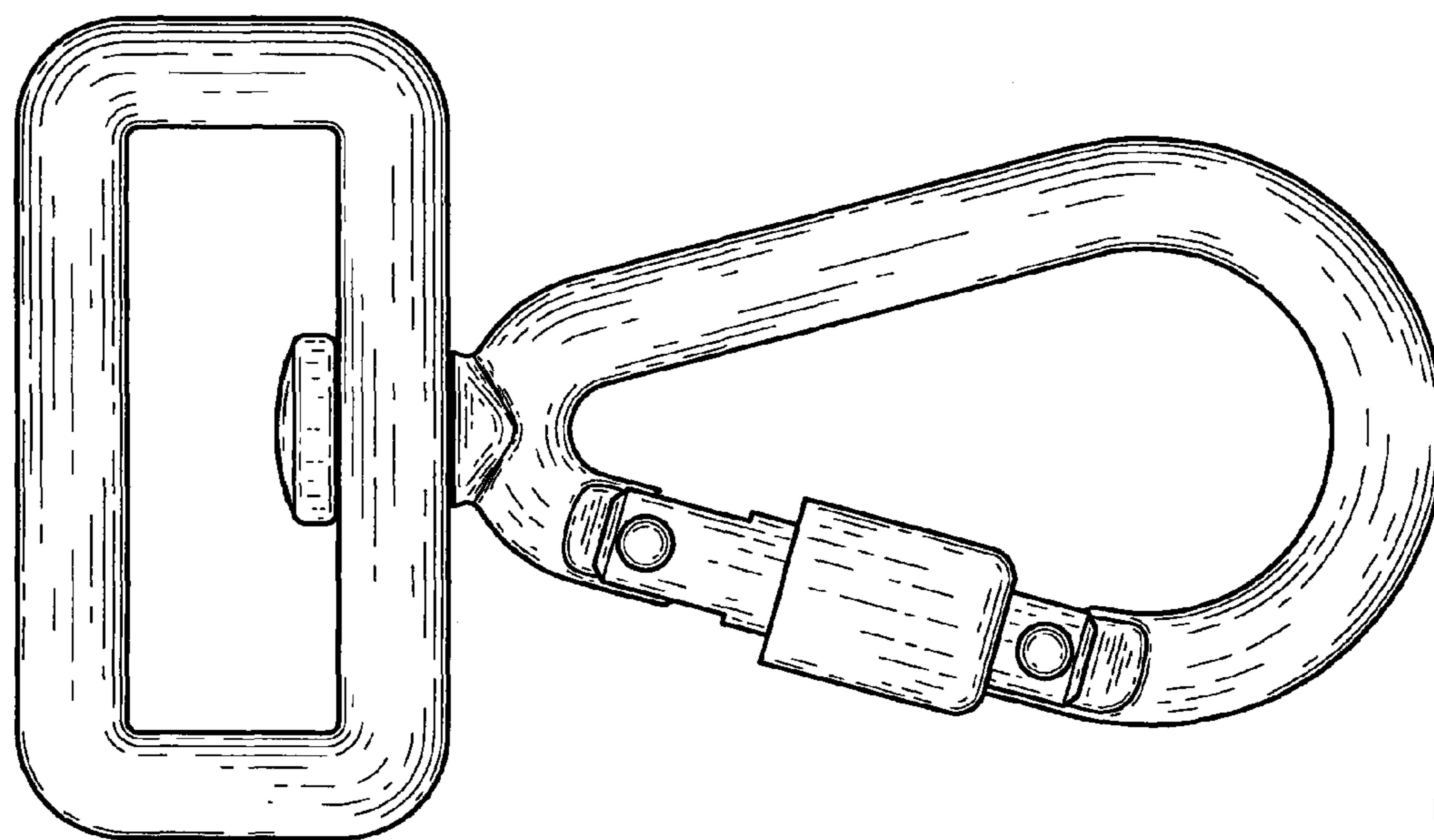

Fig. 23

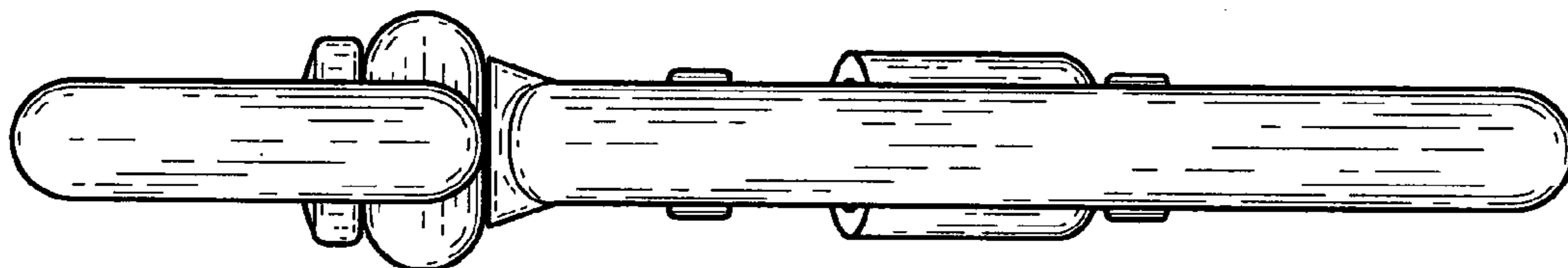

Fig. 25

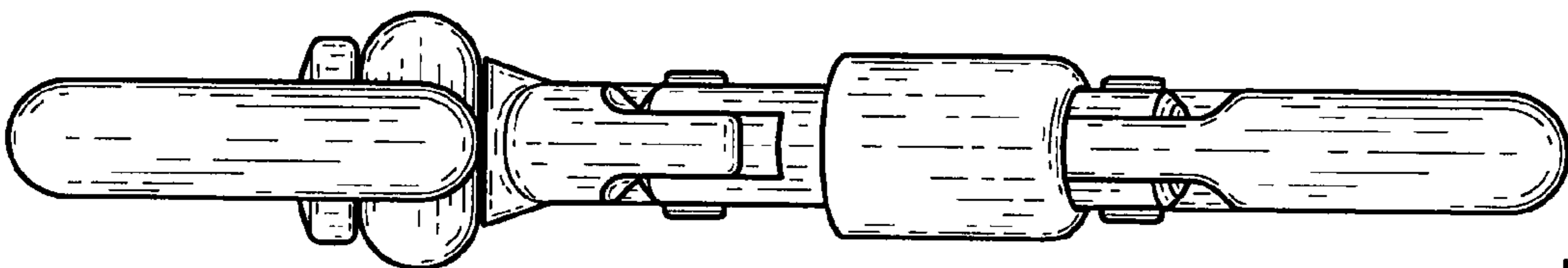

Fig. 26

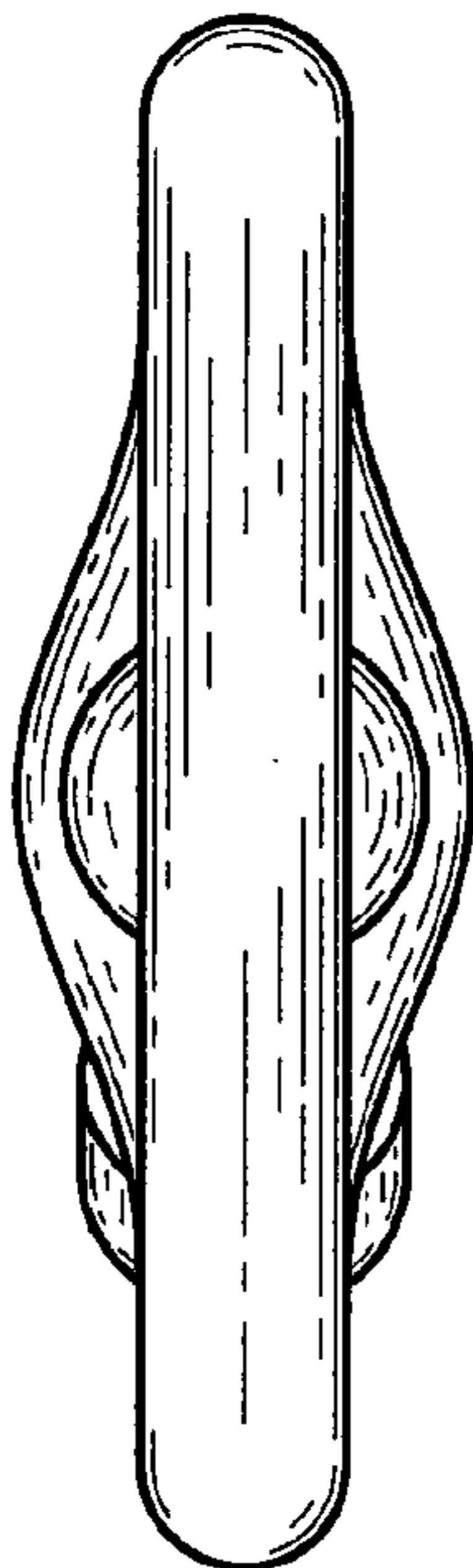

Fig. 27

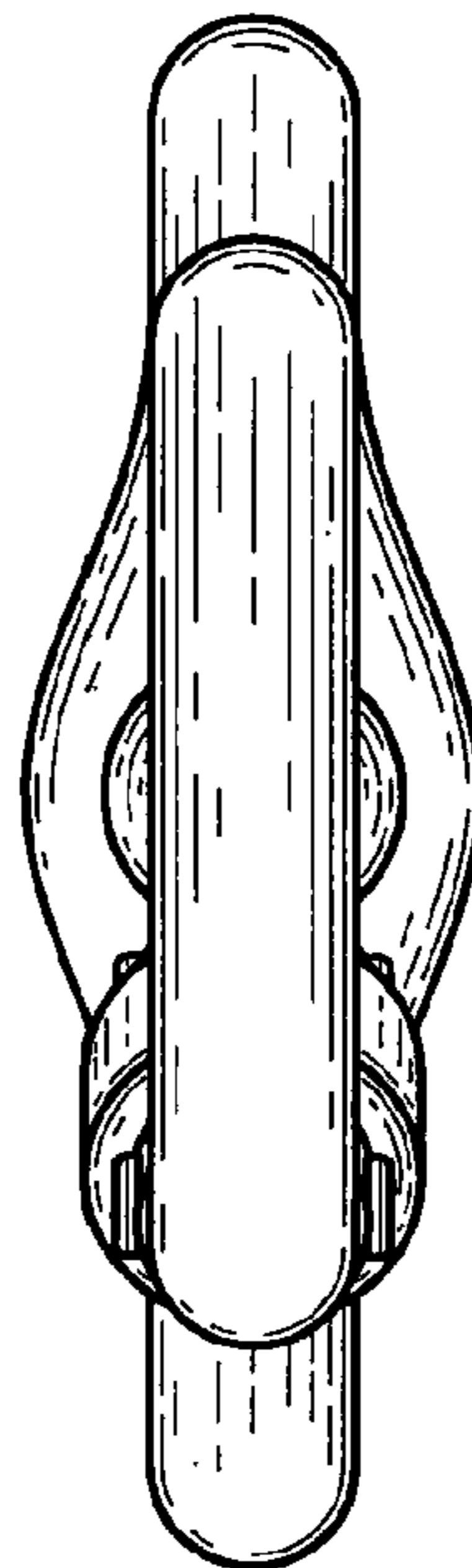

Fig. 28

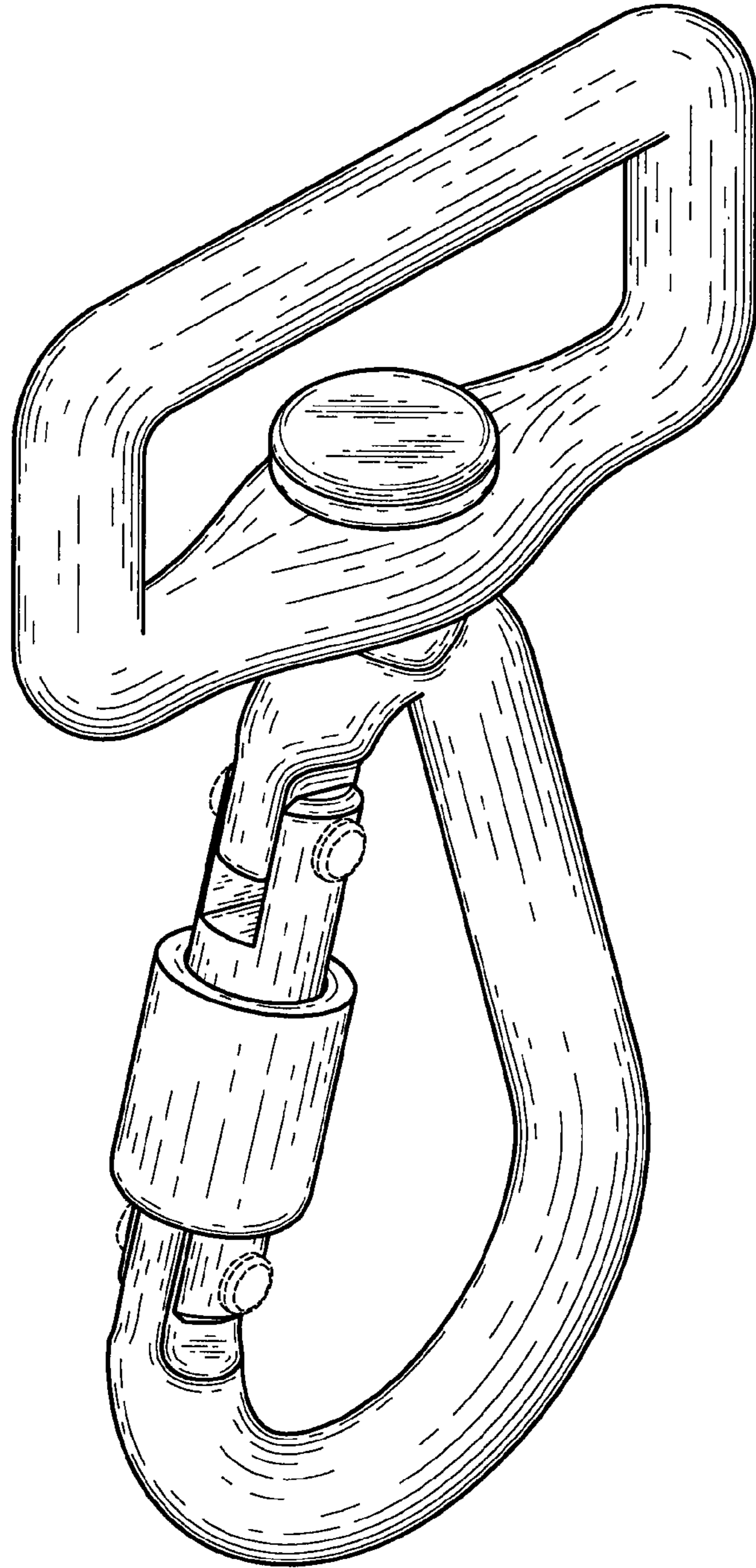

Fig. 29

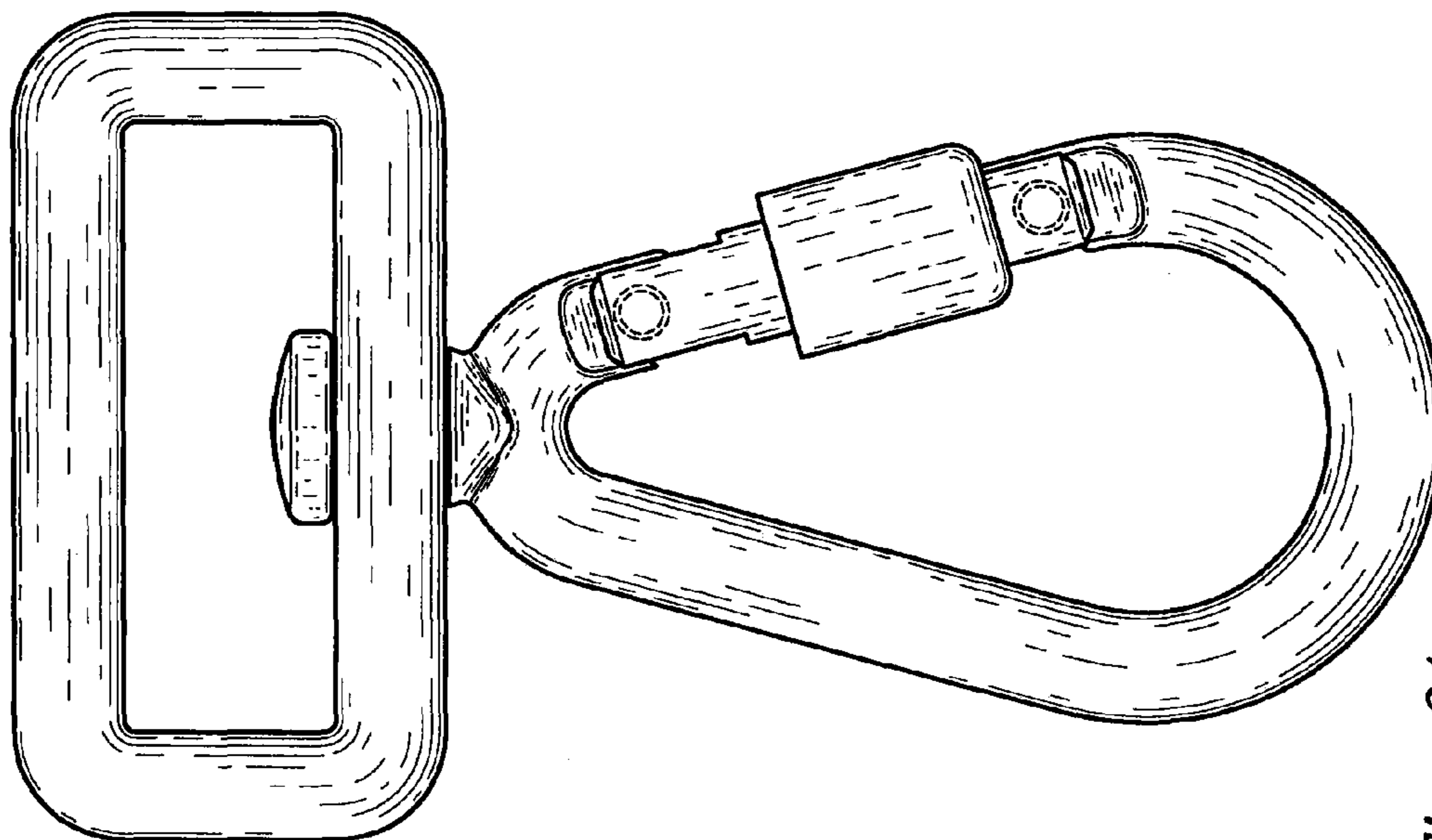

Fig. 31

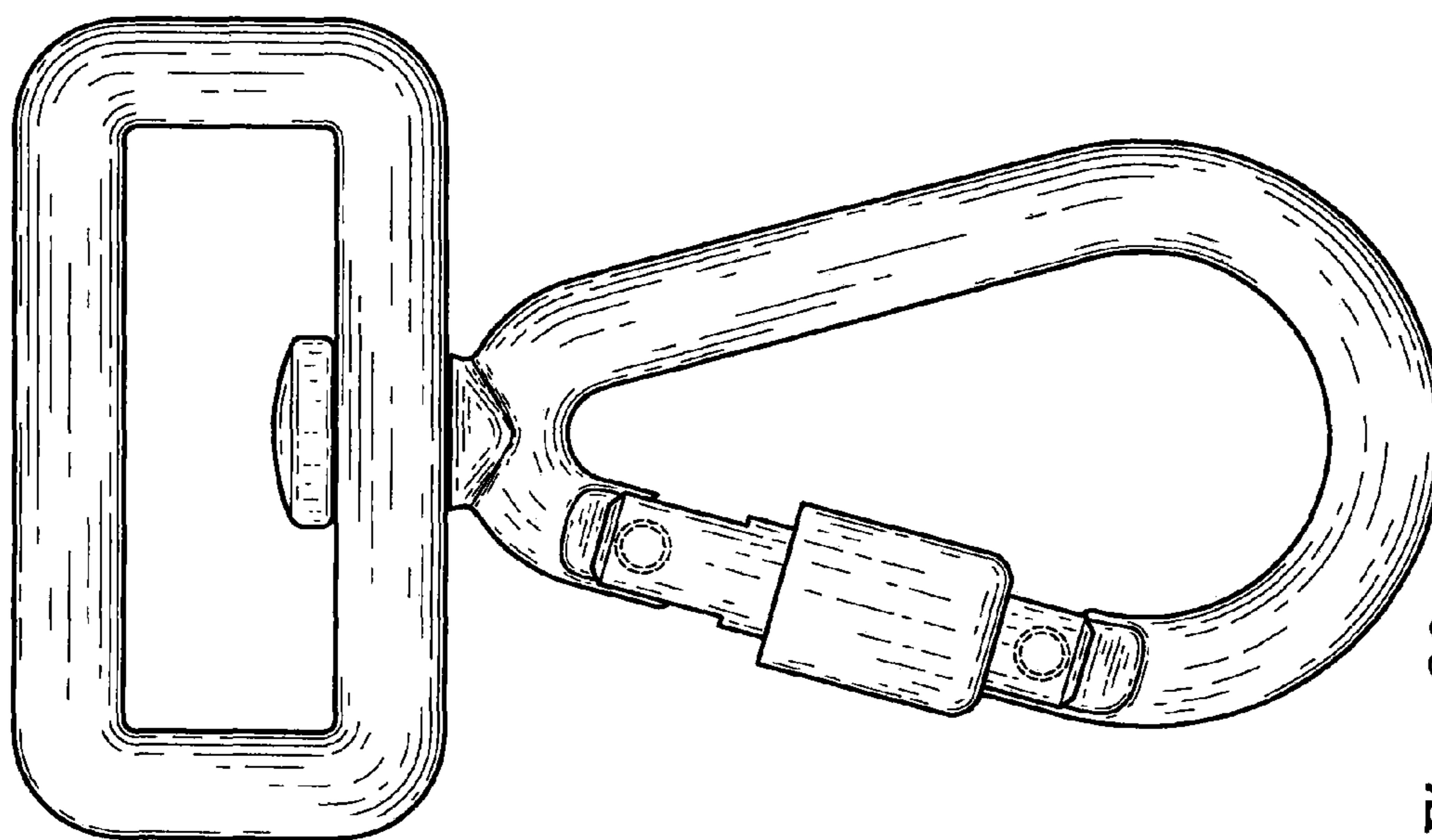

Fig. 30

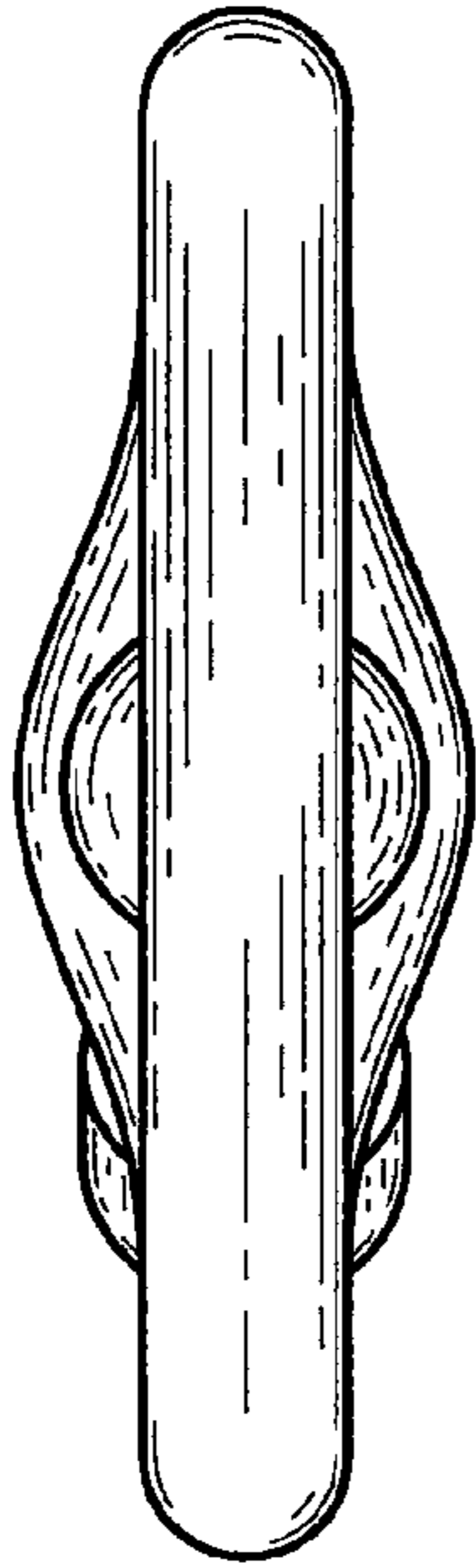

Fig. 34

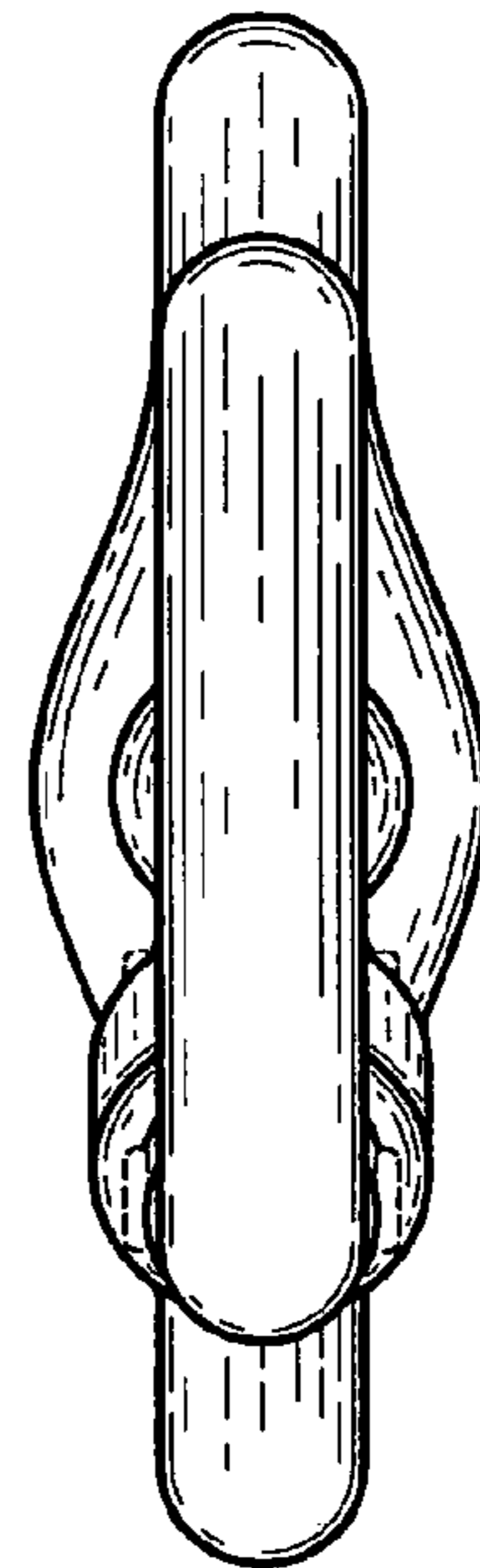

Fig. 35

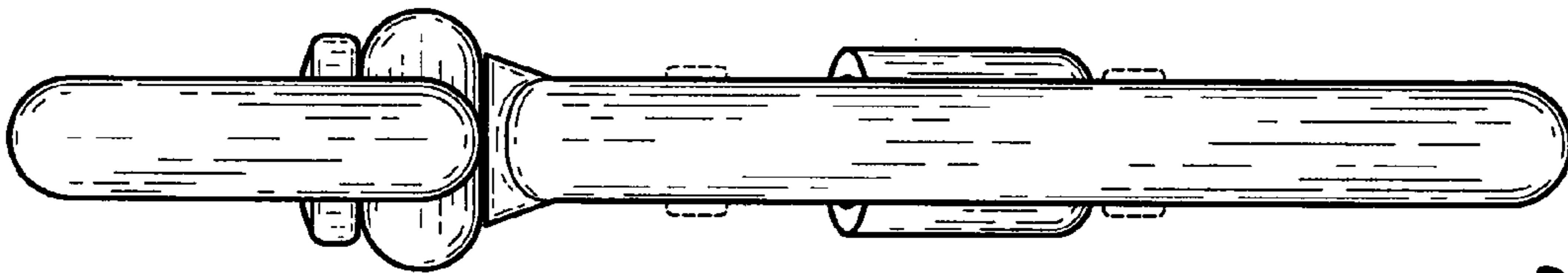

Fig. 33

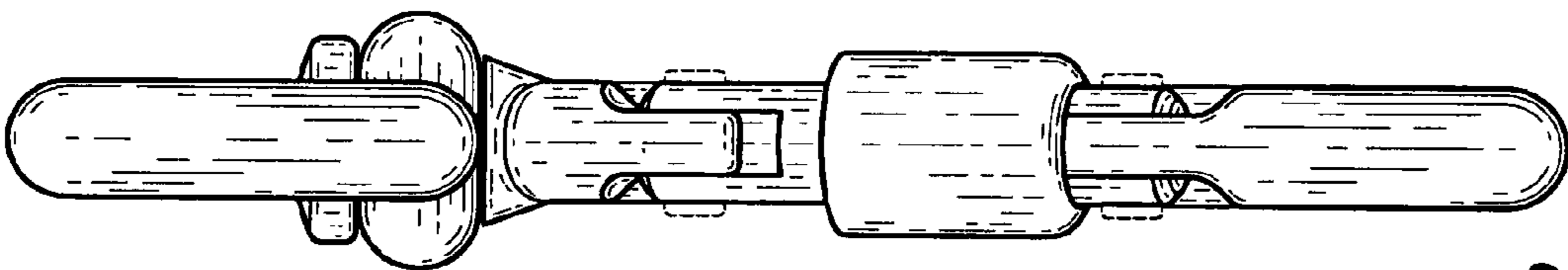

Fig. 32

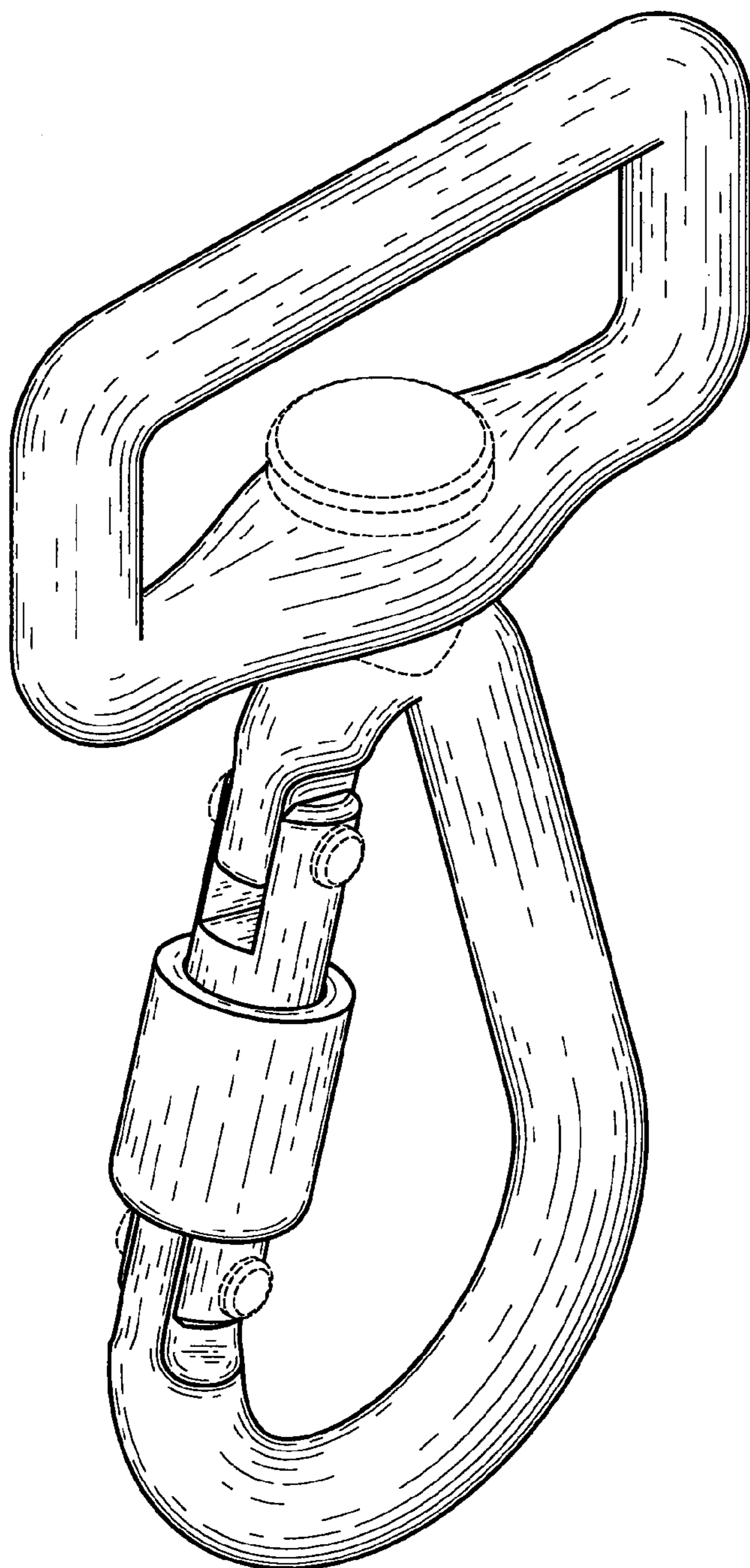

Fig. 36

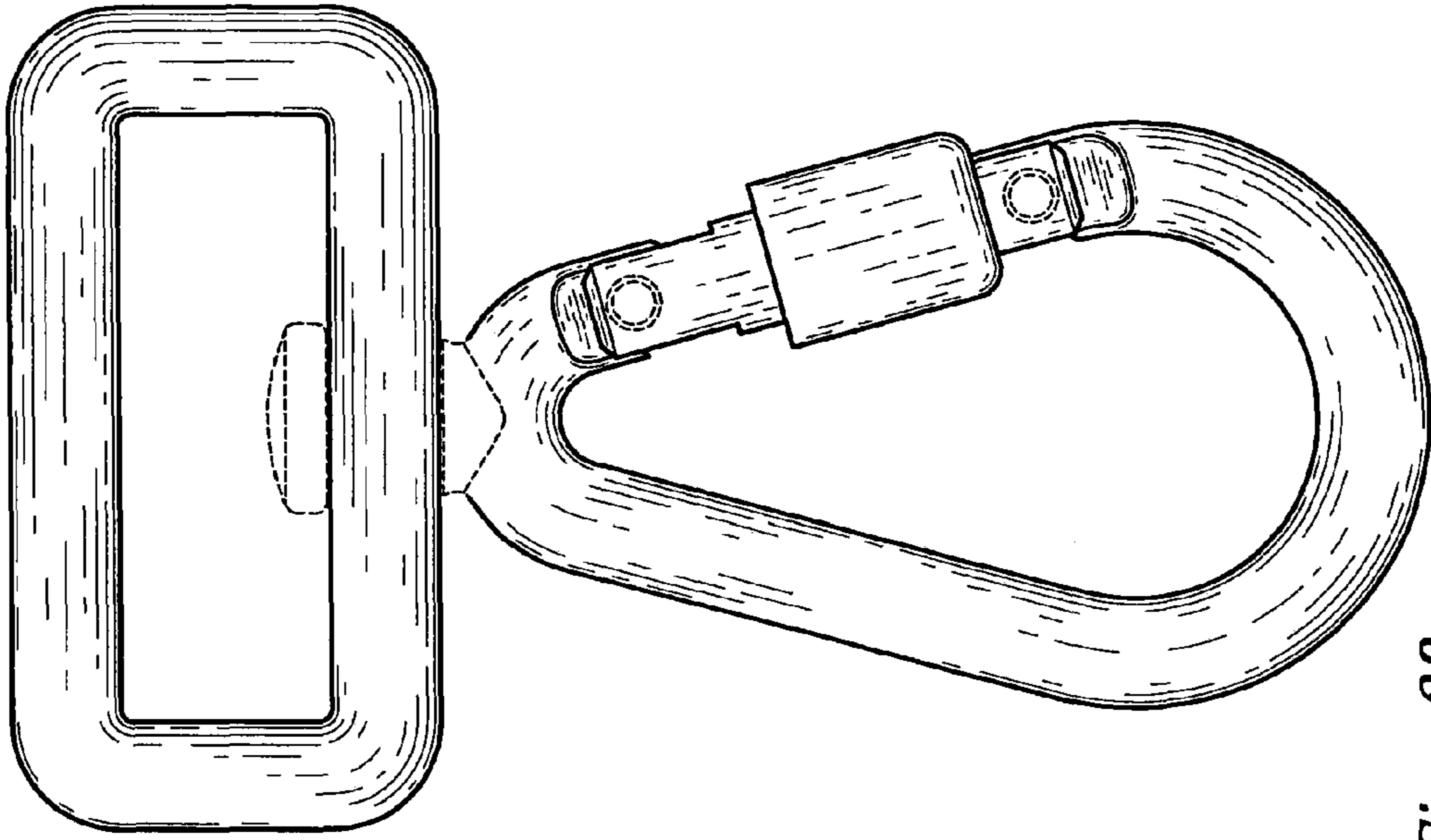

Fig. 38

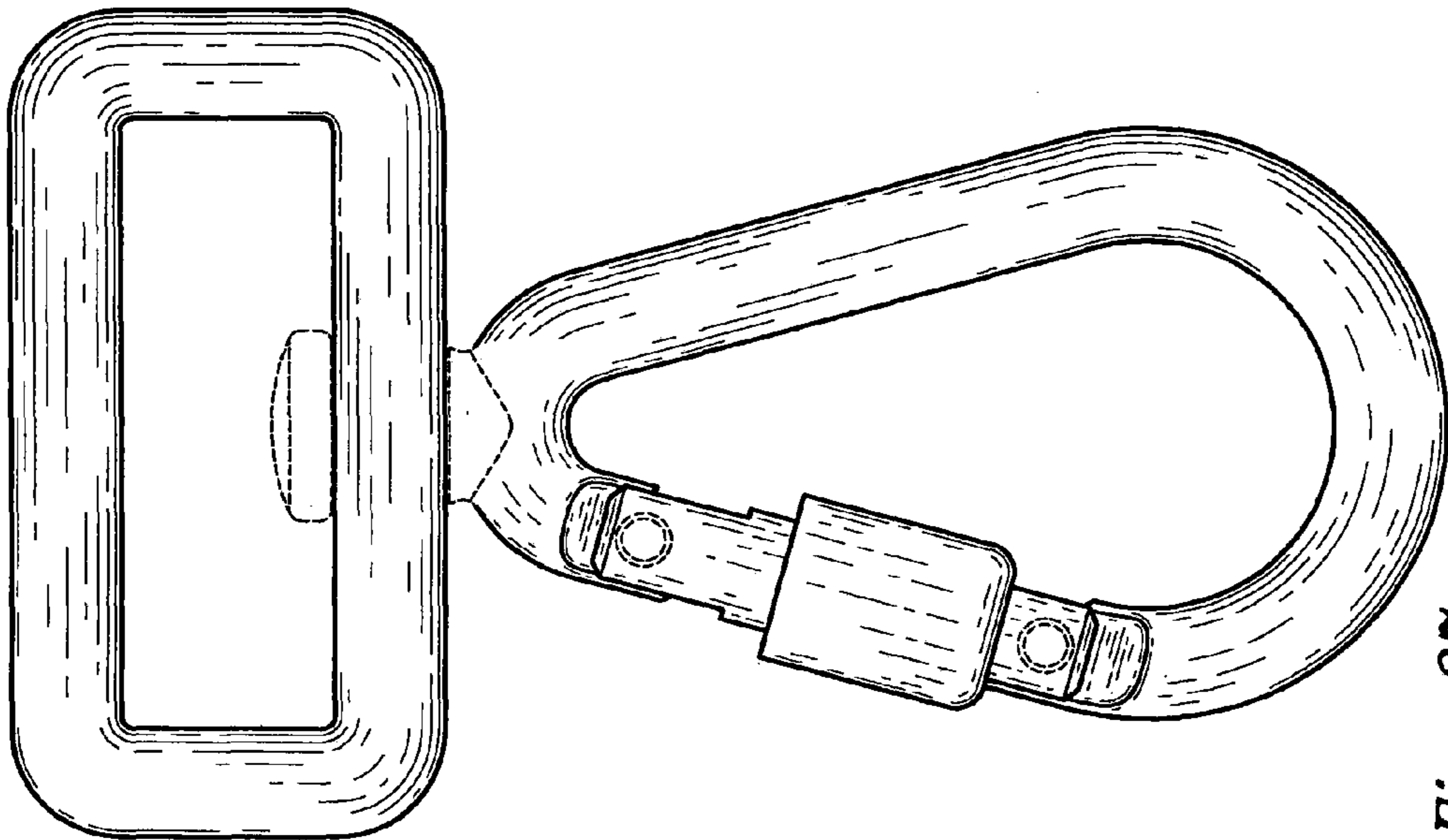

Fig. 37

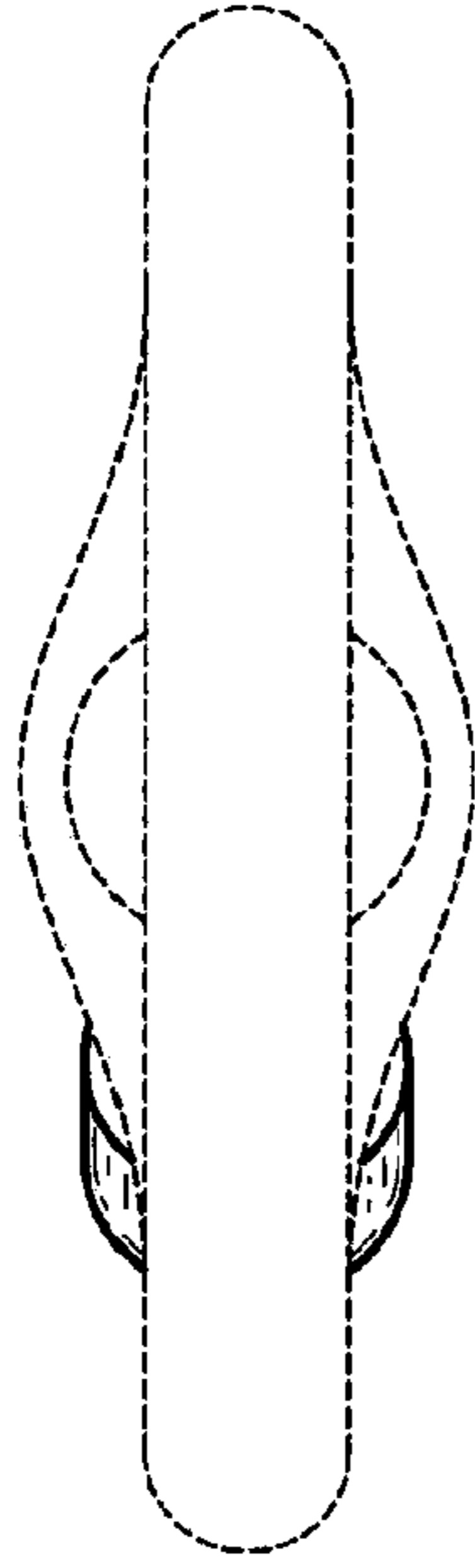

Fig. 41

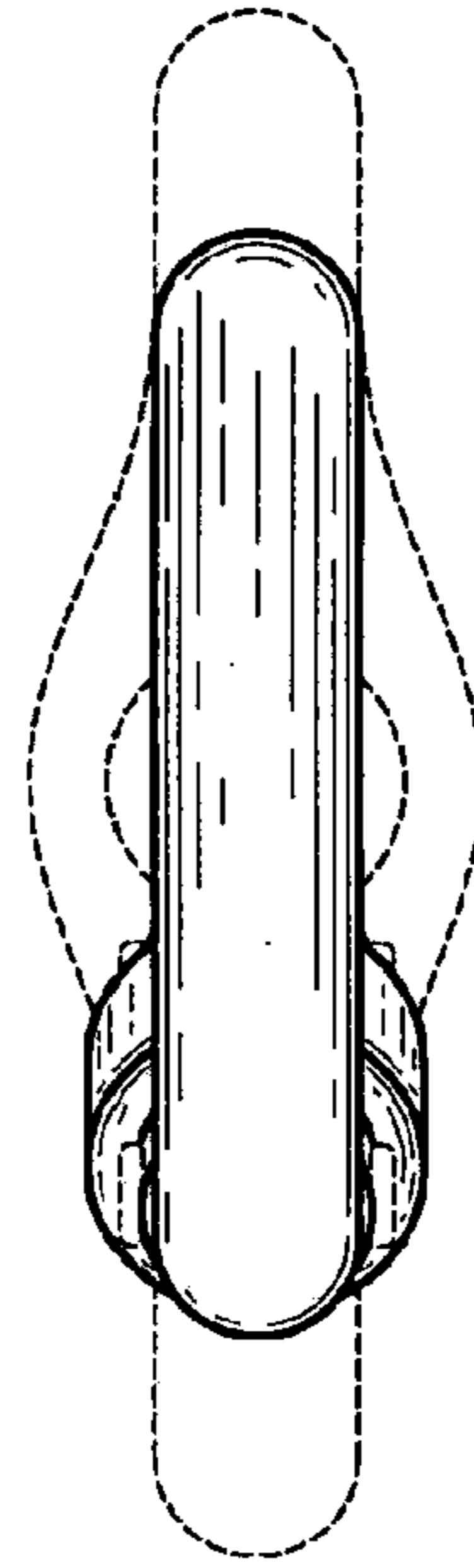

Fig. 42

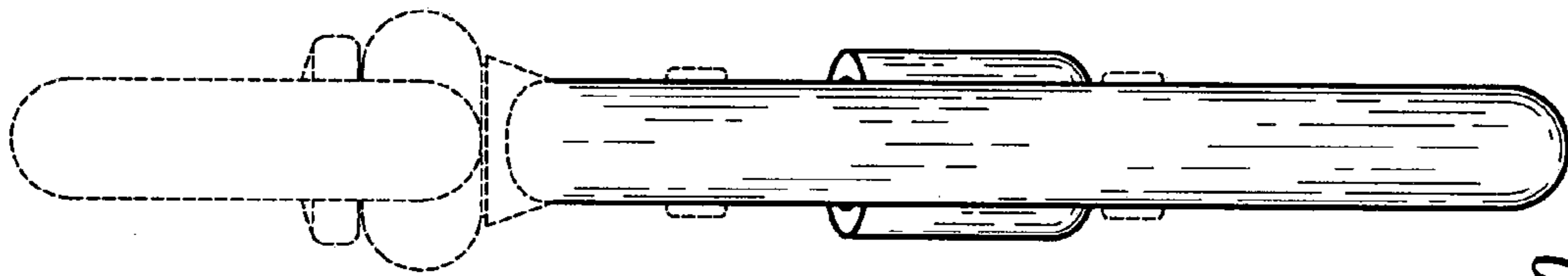

Fig. 40

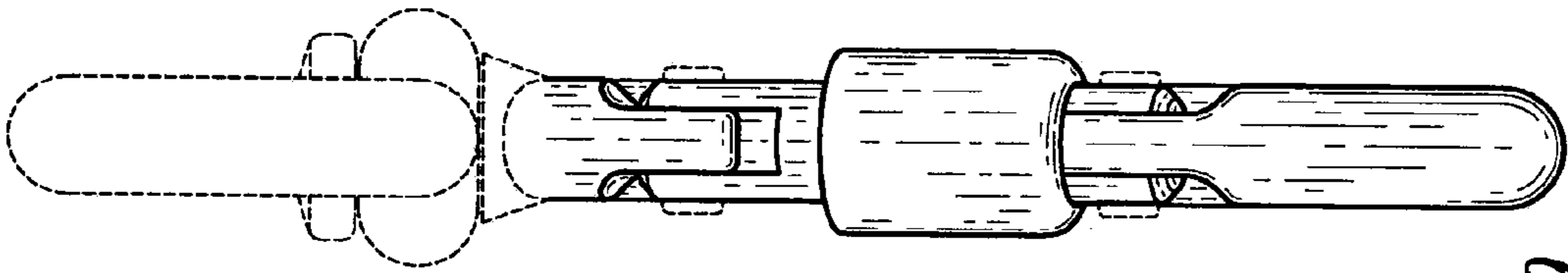

Fig. 39

UNITED STATES PATENT AND TRADEMARK OFFICE
CERTIFICATE OF CORRECTION

PATENT NO. : D649,018 S
APPLICATION NO. : 29/361125
DATED : November 22, 2011
INVENTOR(S) : Kope

Page 1 of 2

It is certified that error appears in the above-identified patent and that said Letters Patent is hereby corrected as shown below:

Delete figs. 39-42 and substitute therefor the drawing sheet, consisting of figs.
39-42 as shown on the attached page.

Signed and Sealed this
Third Day of January, 2012

A handwritten signature in black ink that reads "David J. Kappos". The signature is written in a cursive, slightly slanted style.

David J. Kappos
Director of the United States Patent and Trademark Office

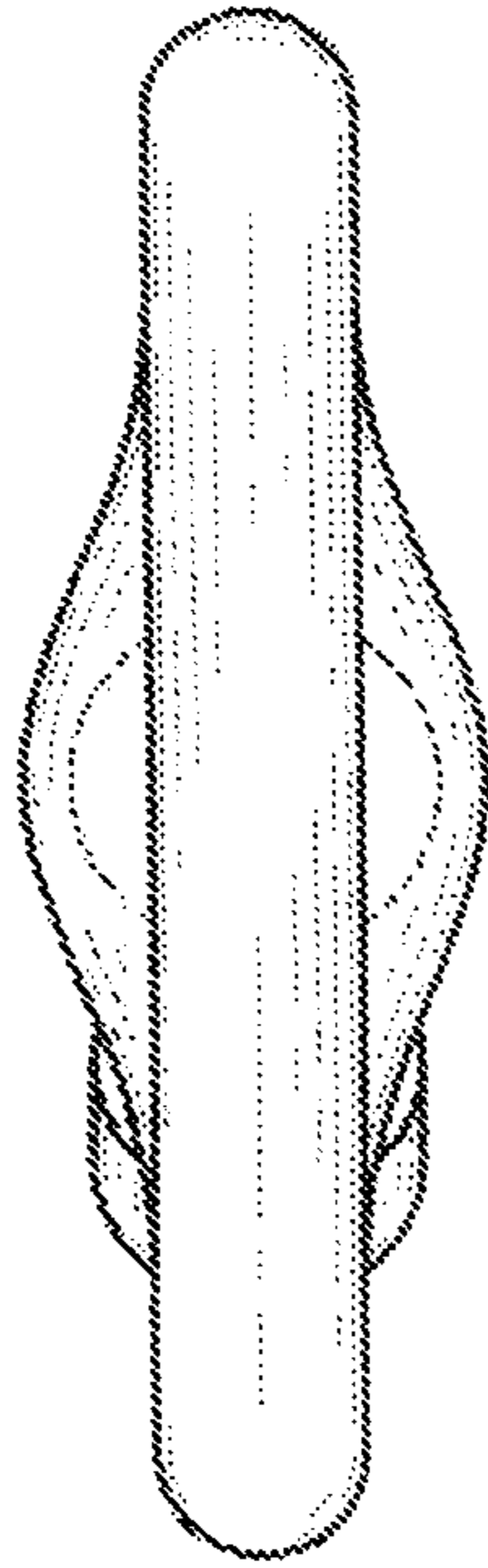

Fig. 41

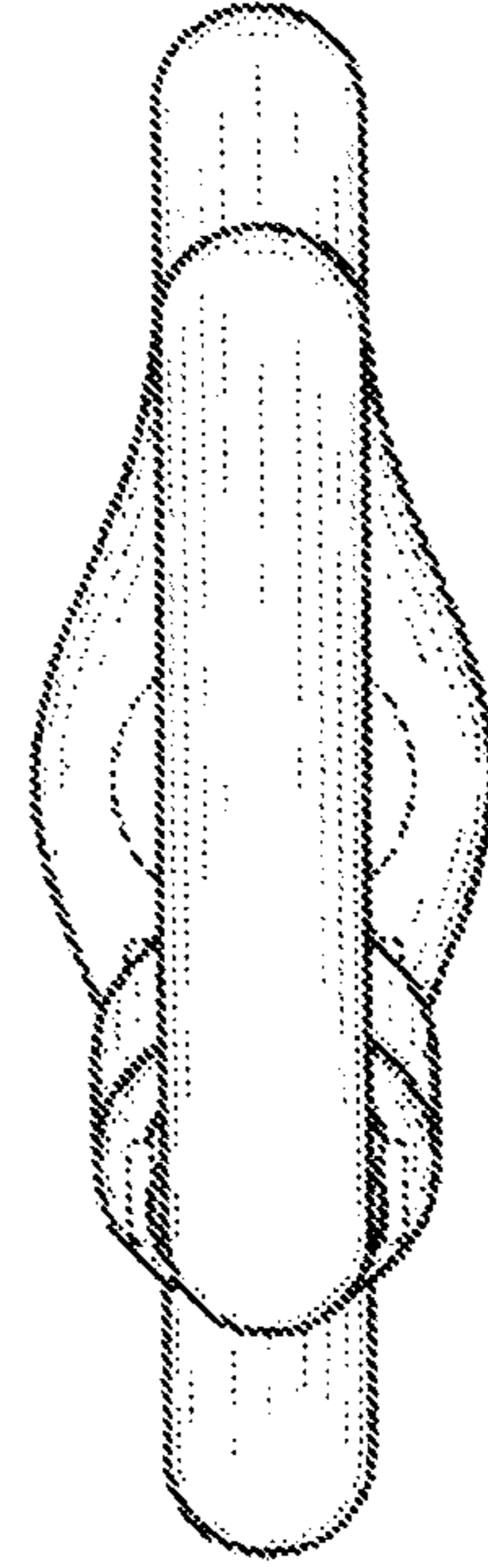

Fig. 42

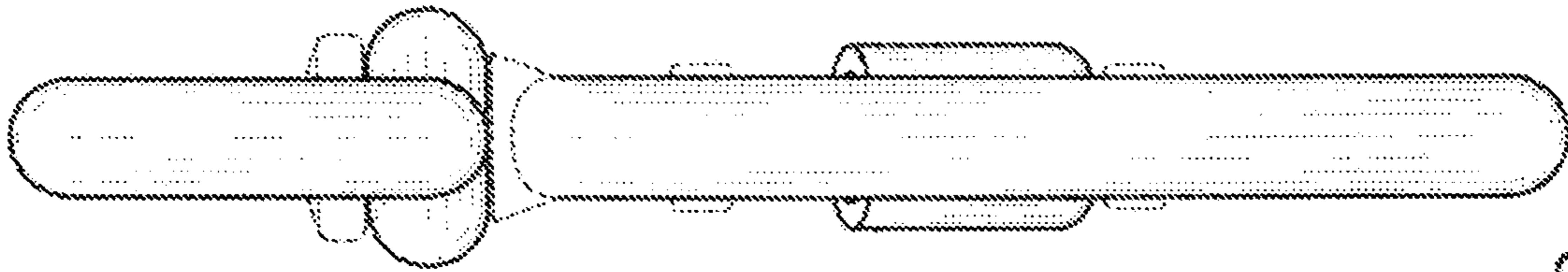

Fig. 40

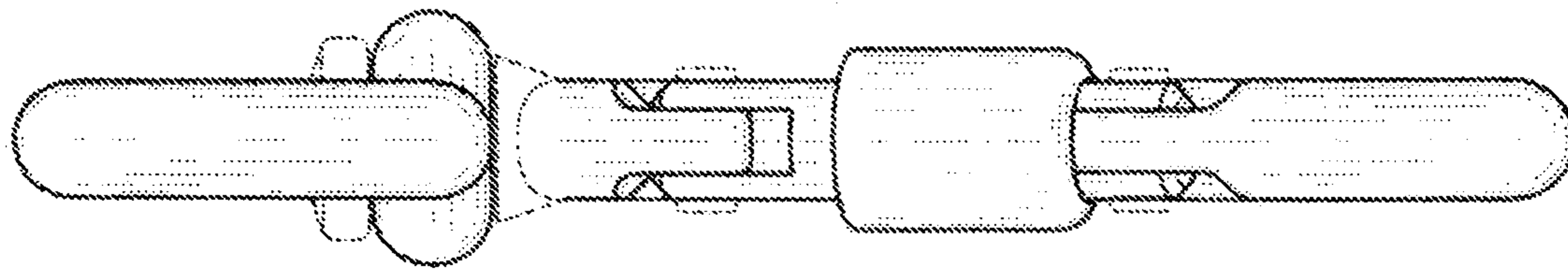

Fig. 39