



US00D648938S

(12) **United States Design Patent**  
**Meersschaert et al.**

(10) **Patent No.:** **US D648,938 S**

(45) **Date of Patent:** **\*\* Nov. 22, 2011**

(54) **LUGGAGE**

(75) Inventors: **Reinhard Meersschaert**, Merelbeke (BE); **Davide Caimi**, Bovisio Masciago (IT)

(73) Assignee: **Samsonite IP Holdings S.a.r.l.**, Luxembourg (LU)

(\*\*) Term: **14 Years**

(21) Appl. No.: **29/378,152**

(22) Filed: **Oct. 29, 2010**

(51) **LOC (9) Cl.** ..... **03-01**

(52) **U.S. Cl.** ..... **D3/279**

(58) **Field of Classification Search** ..... D3/273, D3/276, 279, 281, 283, 289, 291, 301; 190/13 R, 190/100, 101, 103, 106, 107, 108, 109, 111, 190/112, 113, 114, 115, 117, 118, 119, 124, 190/125, 903

See application file for complete search history.

(56) **References Cited**

**U.S. PATENT DOCUMENTS**

5,105,919	A	4/1992	Bomes et al.	
5,265,894	A	11/1993	Dunn	
5,884,737	A	3/1999	Cabo	
5,975,170	A	11/1999	Anguiano	
6,557,702	B1	5/2003	Sanderson et al.	
6,595,334	B1	7/2003	Saetia	
6,763,940	B1	7/2004	Lai	
D500,597	S *	1/2005	Hillman	D3/301
D512,220	S *	12/2005	Van Himbeeck	D3/279

6,994,193	B2	2/2006	Saetia	
D524,049	S *	7/2006	Hughes	D3/289
7,255,145	B2	8/2007	Oh	
D603,163	S *	11/2009	Van Himbeeck	D3/279
2001/0022257	A1	9/2001	Sadow	

\* cited by examiner

*Primary Examiner* — Jennifer Rivard

(74) *Attorney, Agent, or Firm* — Dorsey & Whitney LLP

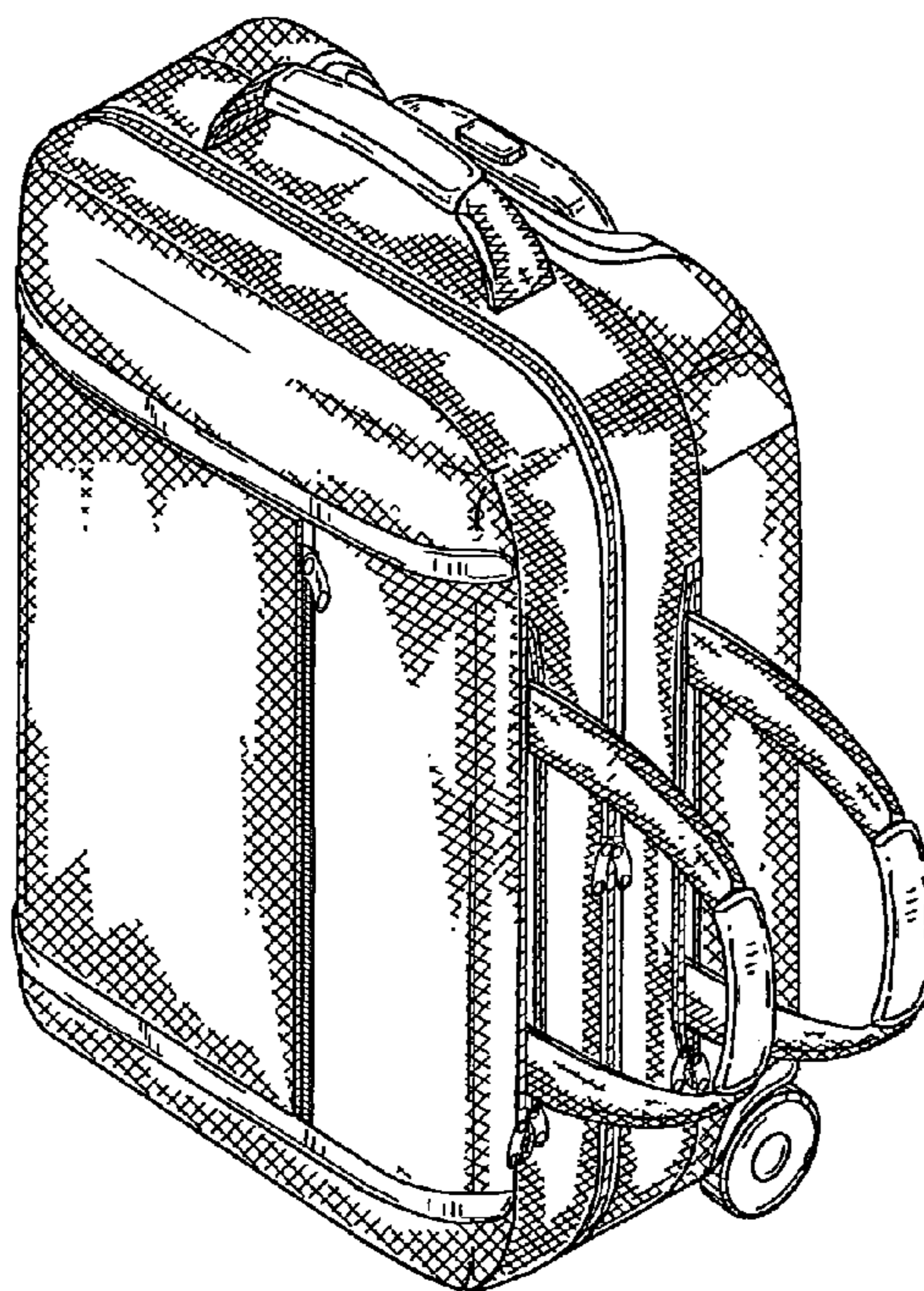
(57) **CLAIM**

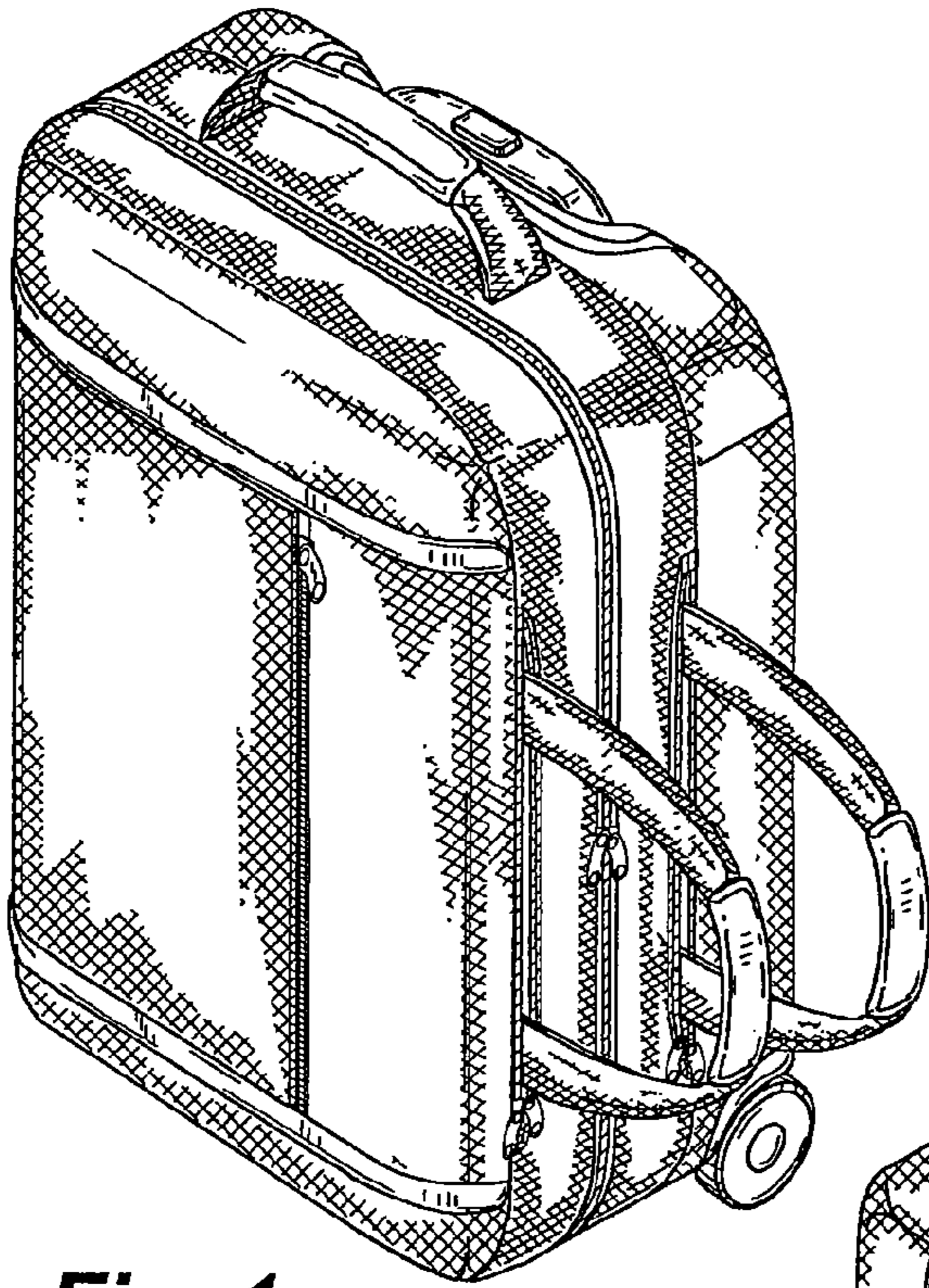
We claim the ornamental design for the luggage, as shown and described.

**DESCRIPTION**

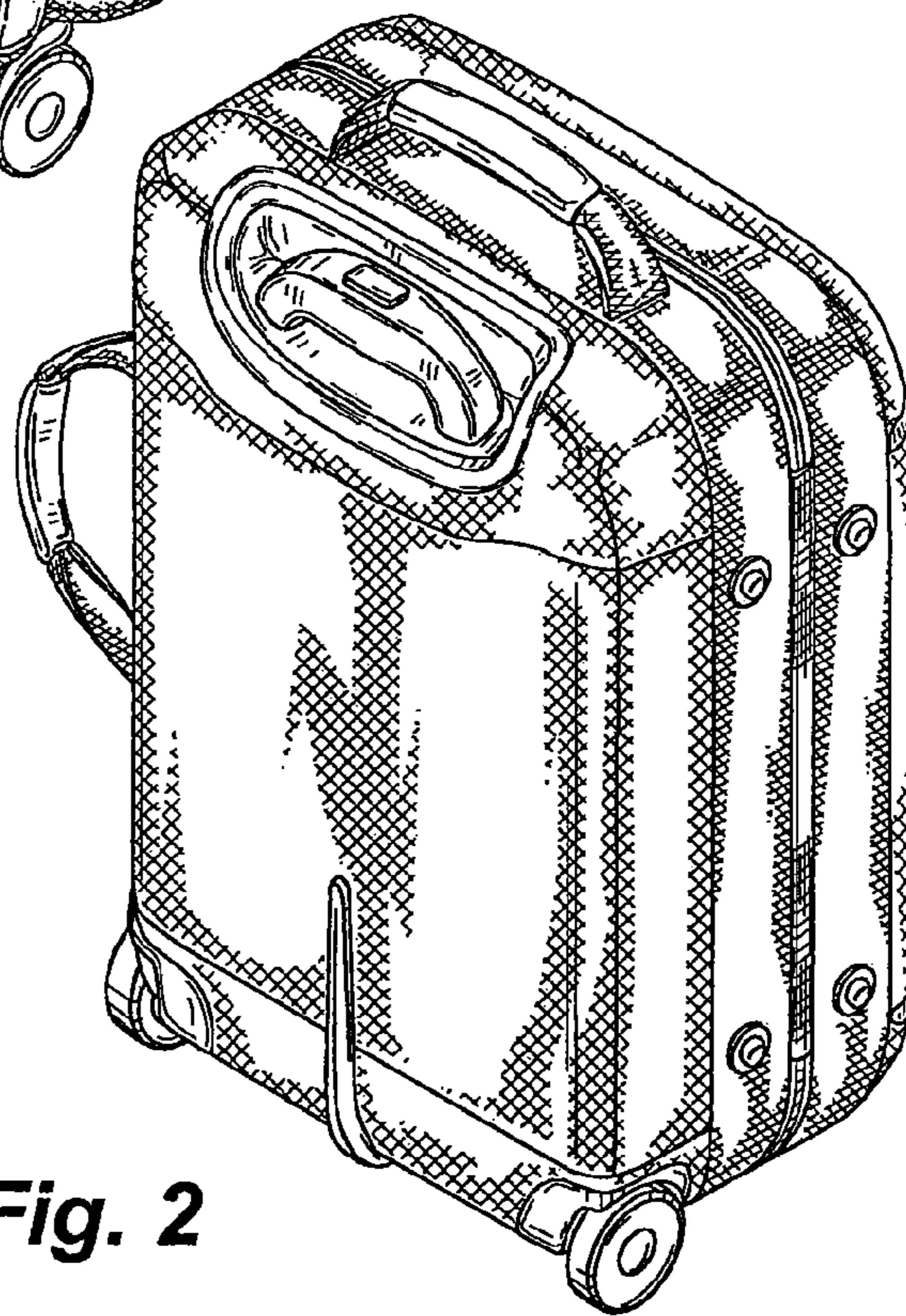
FIG. 1 shows a front perspective view of the luggage; FIG. 2 shows a back perspective view of the luggage of FIG. 1; FIG. 3 shows a rear elevation view of the luggage of FIG. 1; FIG. 4 shows a left elevation view of the luggage of FIG. 1; FIG. 5 shows a top view of the luggage of FIG. 1; FIG. 6 shows a front elevation view of the luggage of FIG. 1; FIG. 7 shows a right elevation view of the luggage of FIG. 1; FIG. 8 shows a bottom view of the luggage of FIG. 1; FIG. 9 shows another front perspective view of the luggage of FIG. 1, showing one of two handles positioned in a stored configuration; FIG. 10 shows another front perspective view of the luggage of FIG. 1, showing another of the two handles positioned in a stored configuration; and, FIG. 11 shows another front perspective of the luggage of FIG. 1, showing both handles positioned in the stored configuration.

**1 Claim, 4 Drawing Sheets**

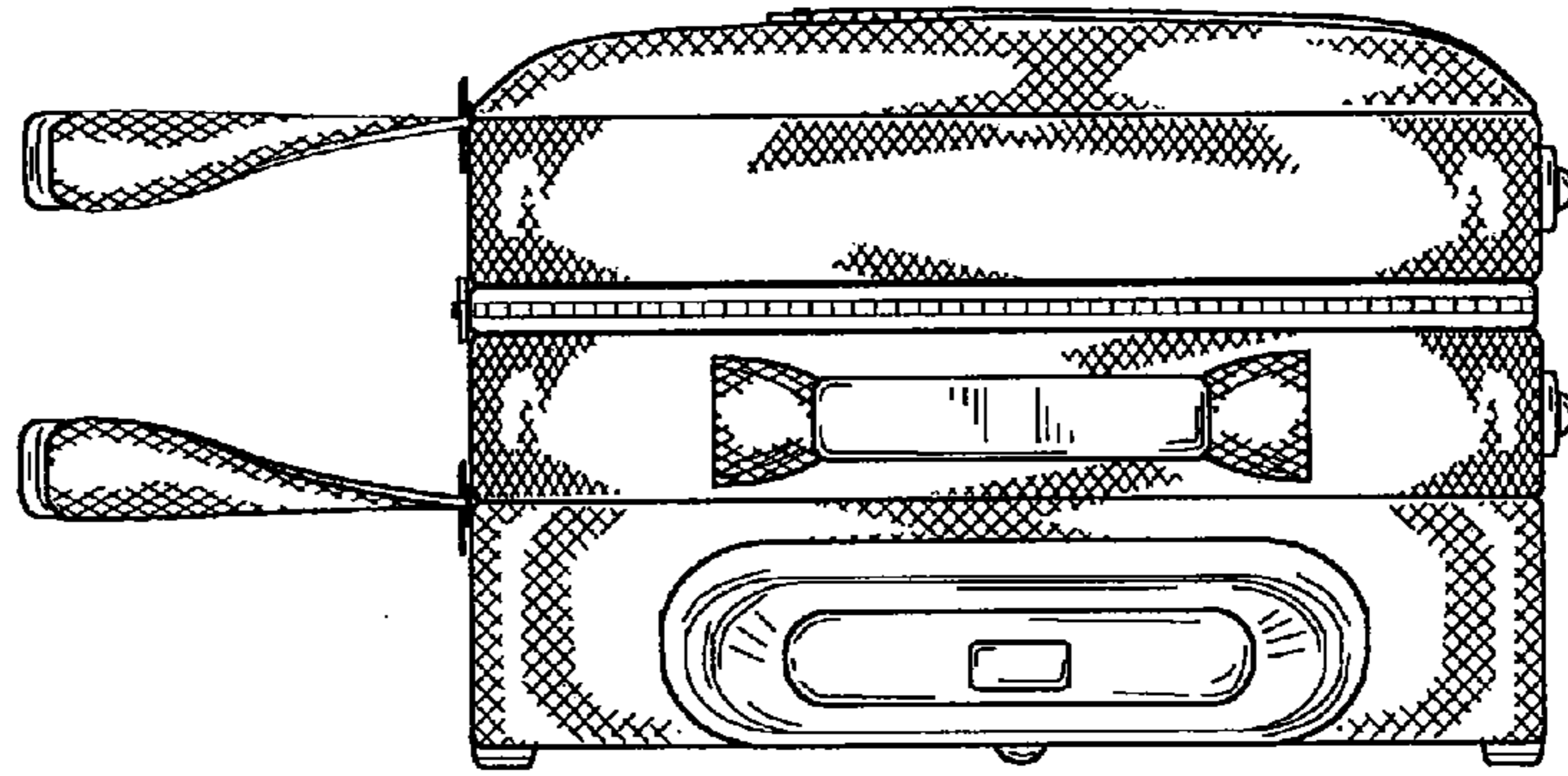




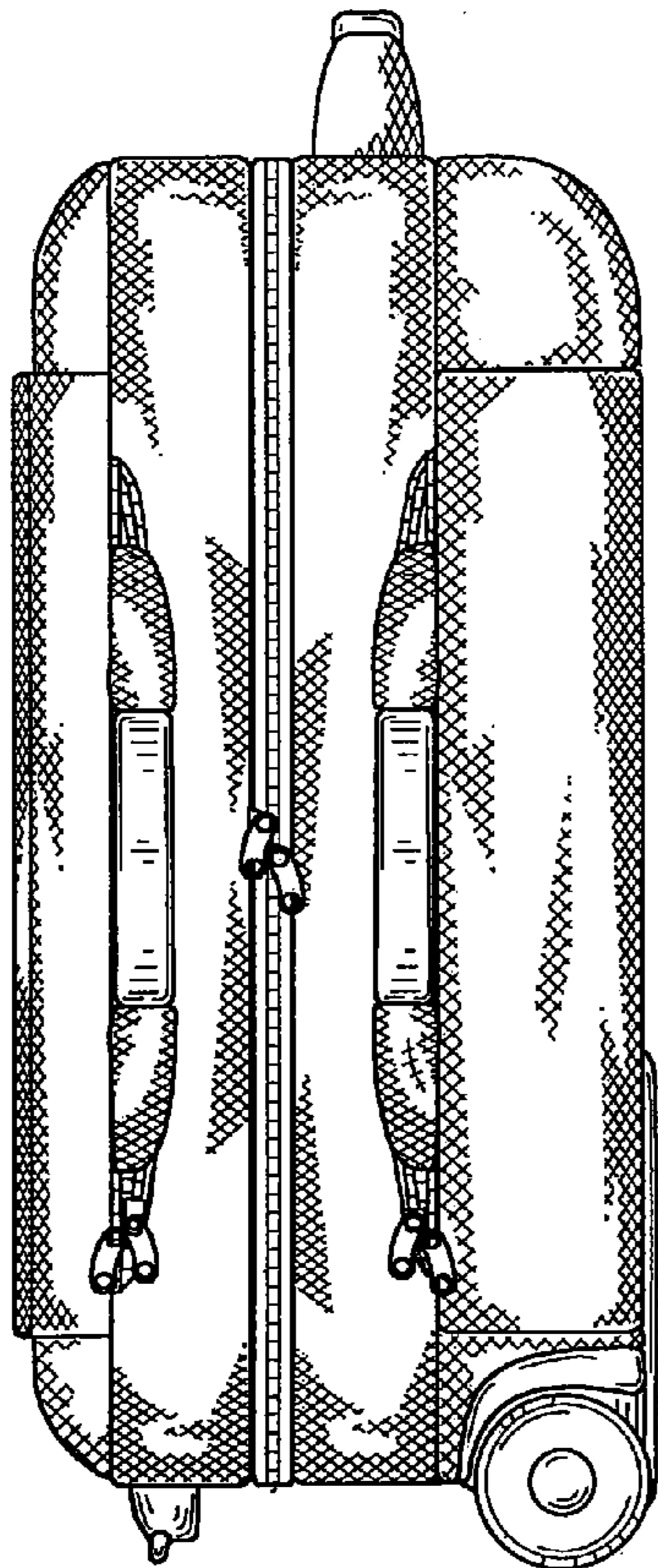
**Fig. 1**



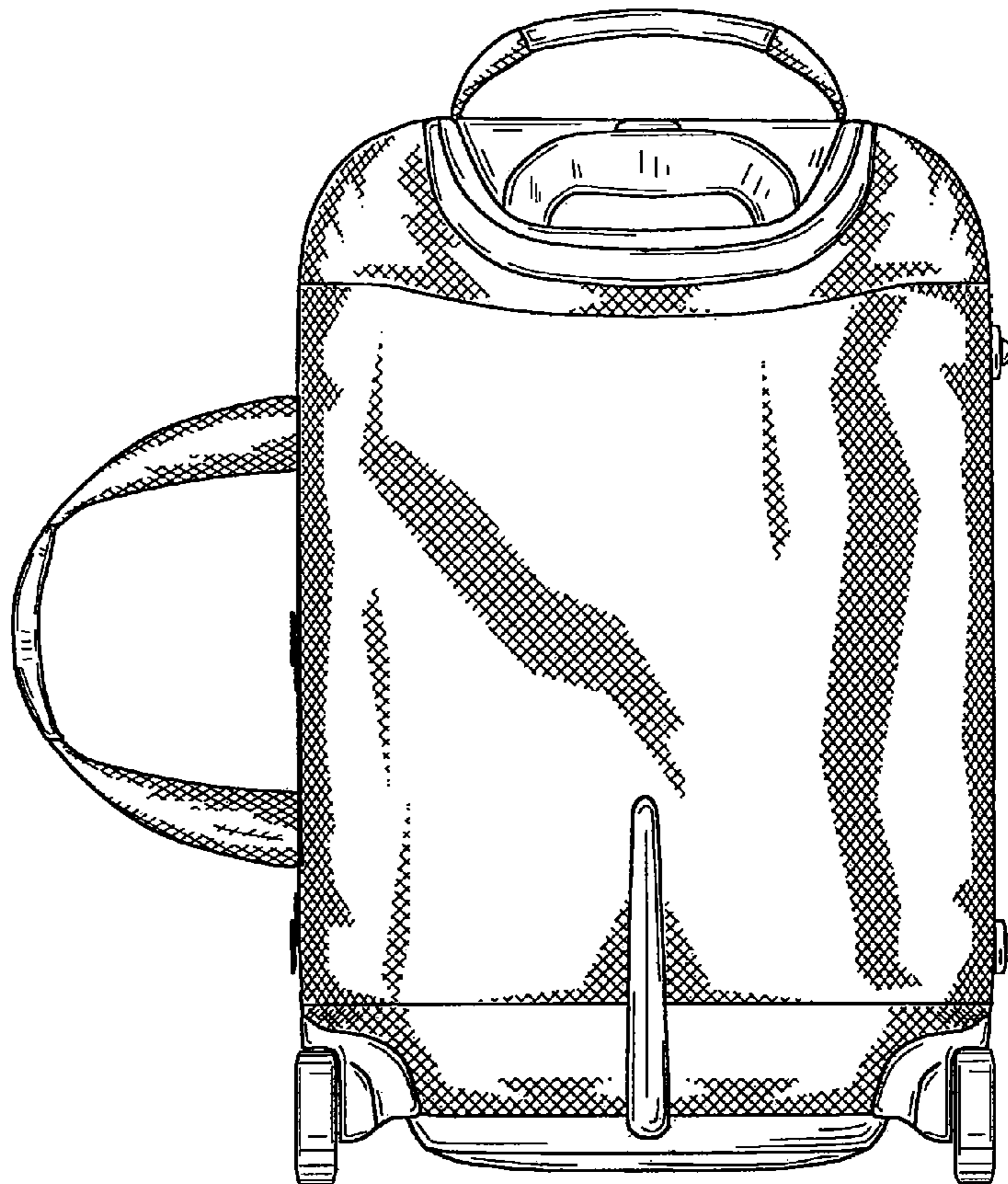
**Fig. 2**



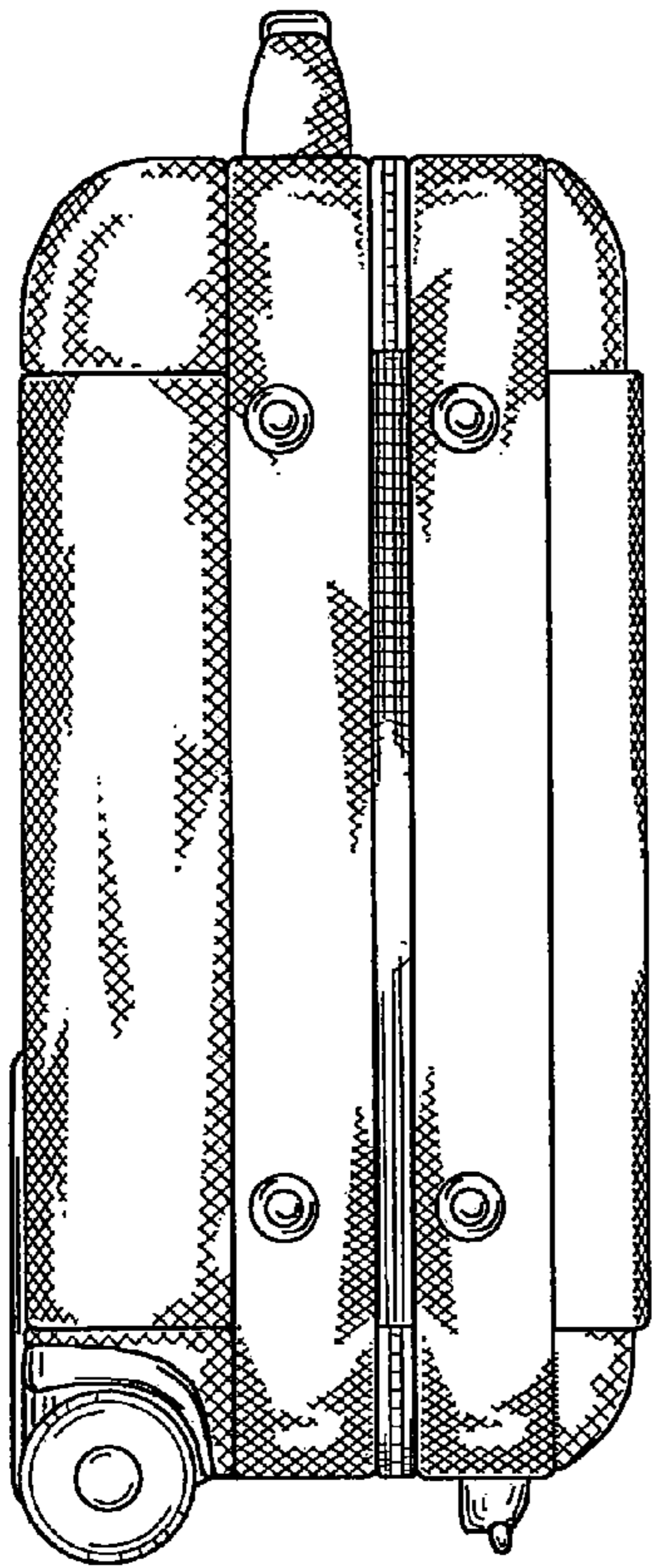
**Fig. 5**



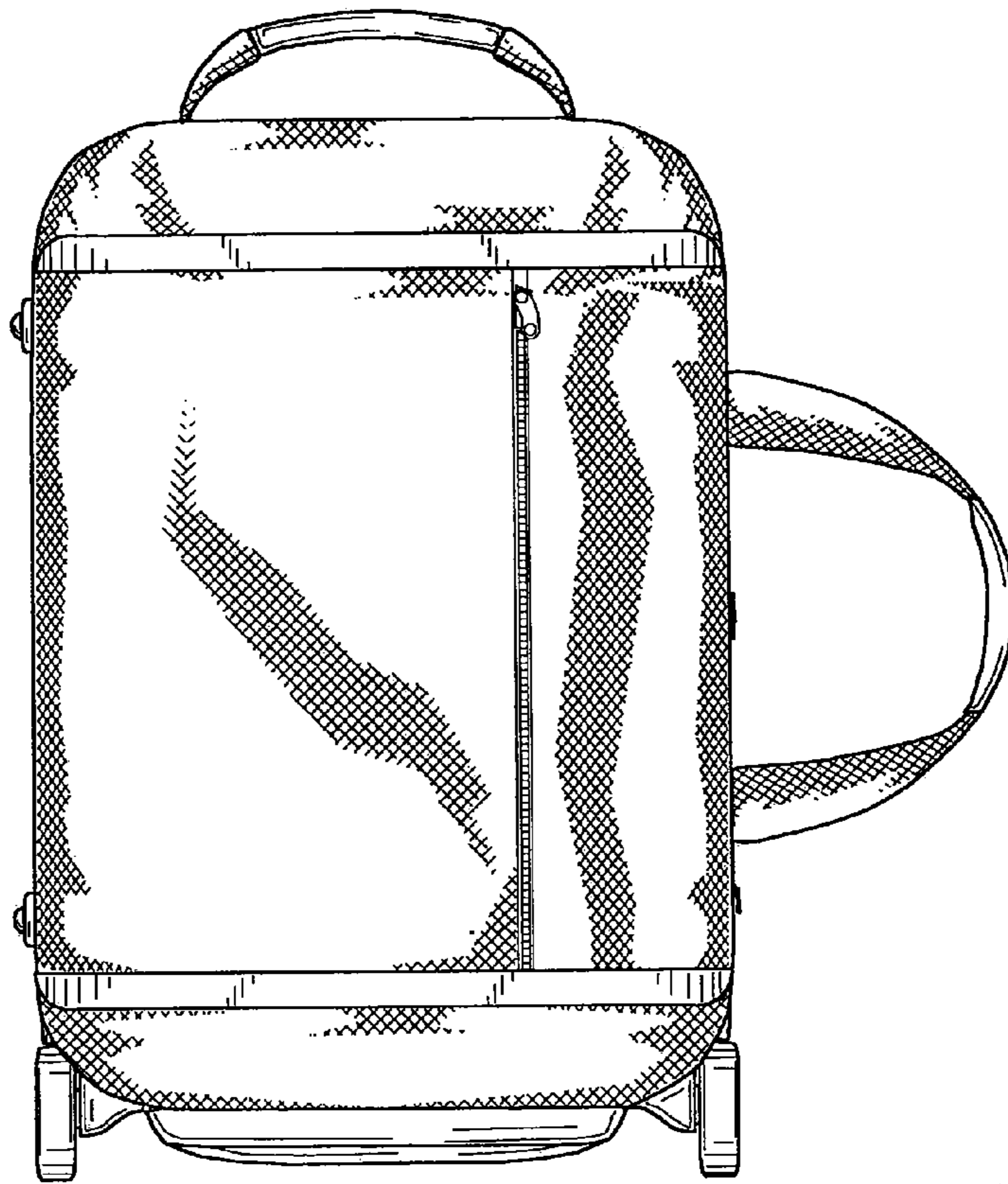
**Fig. 4**



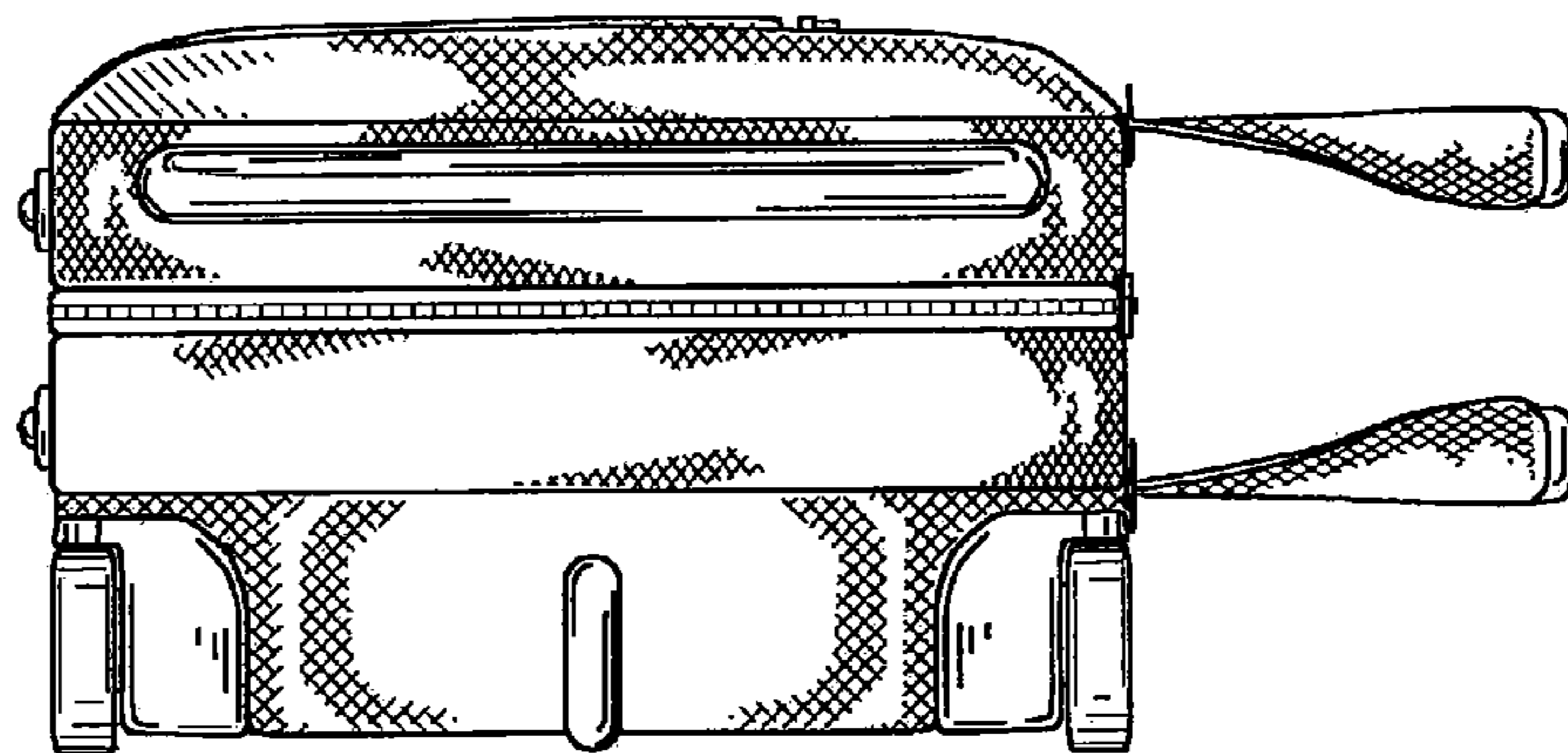
**Fig. 3**



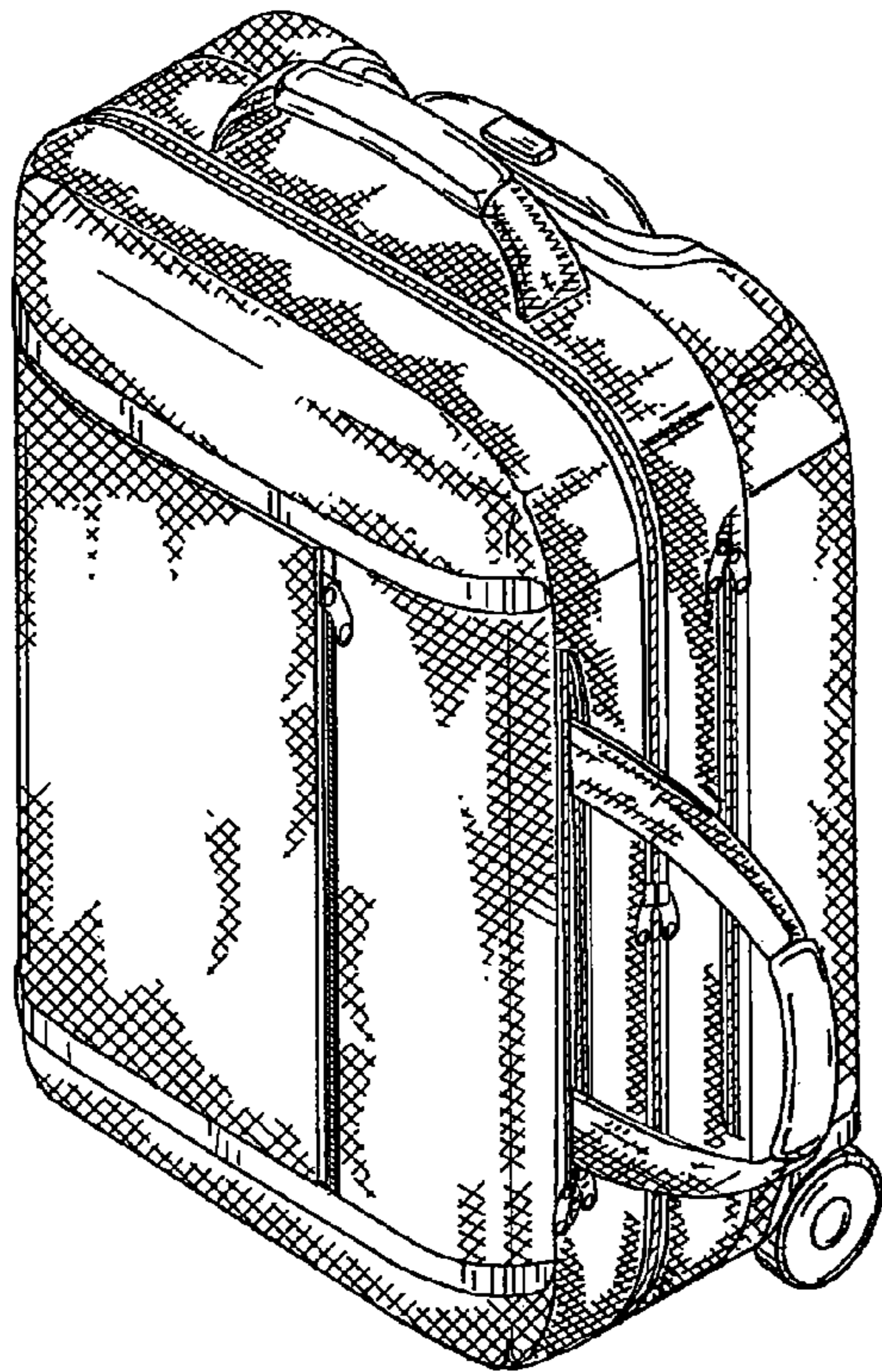
**Fig. 7**



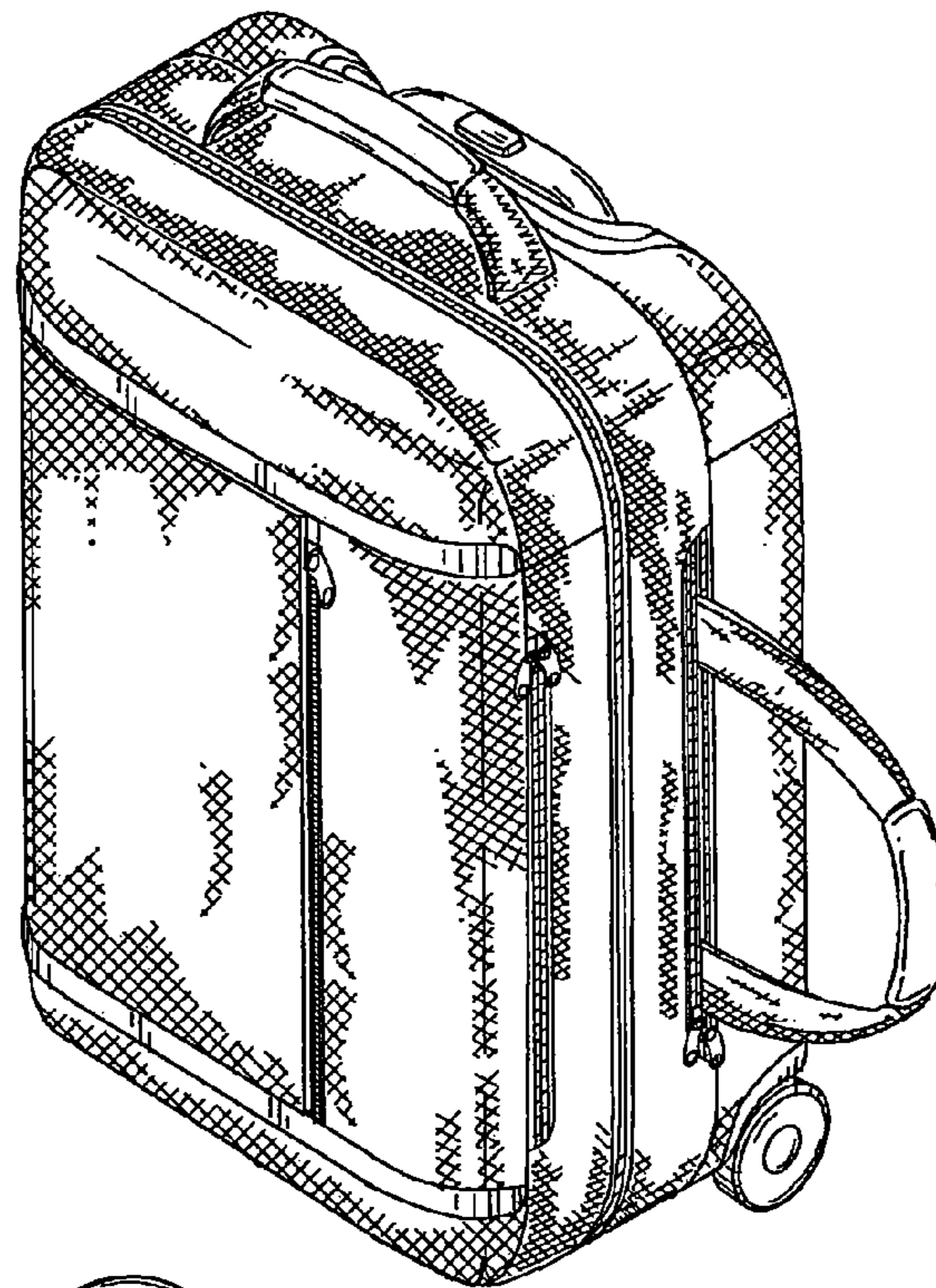
**Fig. 6**



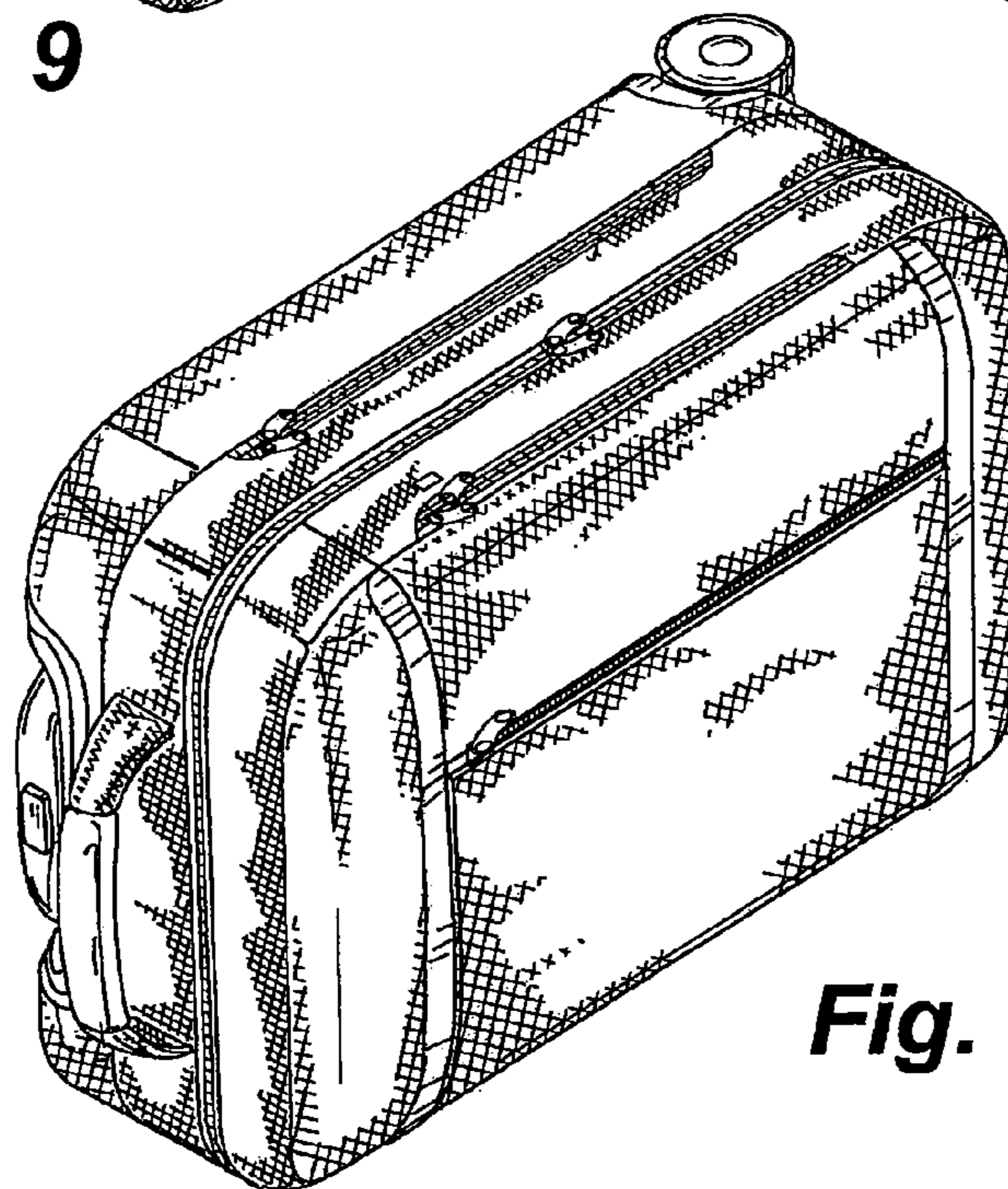
**Fig. 8**



**Fig. 9**



**Fig. 10**



**Fig. 11**