



US00D648921S

(12) **United States Design Patent**
Holtman

(10) **Patent No.:** **US D648,921 S**

(45) **Date of Patent:** **** Nov. 22, 2011**

(54) **BOOT DONNING ASSISTANCE APPARATUS**

(76) Inventor: **Joe Lee Holtman**, Idalou, TX (US)

(**) Term: **14 Years**

(21) Appl. No.: **29/382,407**

(22) Filed: **Jan. 3, 2011**

(51) **LOC (9) Cl.** **07-99**

(52) **U.S. Cl.** **D2/641**

(58) **Field of Classification Search** D2/641,
D2/642, 643; 223/111, 112, 113, 114, 115,
223/116, 117, 118, 119

See application file for complete search history.

4,666,070	A *	5/1987	McClung	223/117
D317,077	S	5/1991	Schulz		
5,050,784	A *	9/1991	Turner	223/114
D338,100	S	8/1993	Fuccillo		
D372,113	S	7/1996	Palmer et al.		
6,132,002	A *	10/2000	Brown, II	297/423.41
6,808,094	B1 *	10/2004	Hogg	223/114
7,070,074	B2 *	7/2006	Landsberger et al.	223/113

* cited by examiner

Primary Examiner — T. Chase Nelson

Assistant Examiner — Kathleen M Sims

(74) *Attorney, Agent, or Firm* — Aaron R. Clements

(57) **CLAIM**

The ornamental design for a boot donning assistance apparatus, as shown and described.

DESCRIPTION

FIG. 1 shows an oblique view of the boot donning assistance apparatus showing the new design.

FIG. 2 shows a side view of the apparatus.

FIG. 3 shows an opposite side view of the apparatus.

FIG. 4 shows a top view of the apparatus.

FIG. 5 shows a front view of the apparatus.

FIG. 6 shows a rear view of the apparatus; and,

FIG. 7 shows a bottom view of the apparatus.

The ornamental design for a boot donning assistance apparatus includes four vertical bars connected by a base and a top crossbar with a circled star between two of the bars and a pin on each of the vertical bars.

1 Claim, 3 Drawing Sheets

(56) **References Cited**

U.S. PATENT DOCUMENTS

28,927	A	6/1860	Wheeler		
192,485	A	6/1877	Buzzell		
459,680	A	9/1891	Donauer		
462,380	A	11/1891	Gruendler		
624,473	A *	5/1899	Fredman et al.	223/118
2,603,393	A	7/1952	Oblusteel		
D216,451	S *	1/1970	Fox	D2/642
D223,182	S	3/1972	Powell		
D246,078	S *	10/1977	Bailey	D2/642
D247,141	S *	2/1978	Bailey	D2/642
D254,756	S *	4/1980	Brown	D2/642
D259,301	S	5/1981	Cowart et al.		
D287,785	S	1/1987	Lauhoff		
4,637,533	A	1/1987	Black		
D288,030	S	2/1987	Lauhoff		

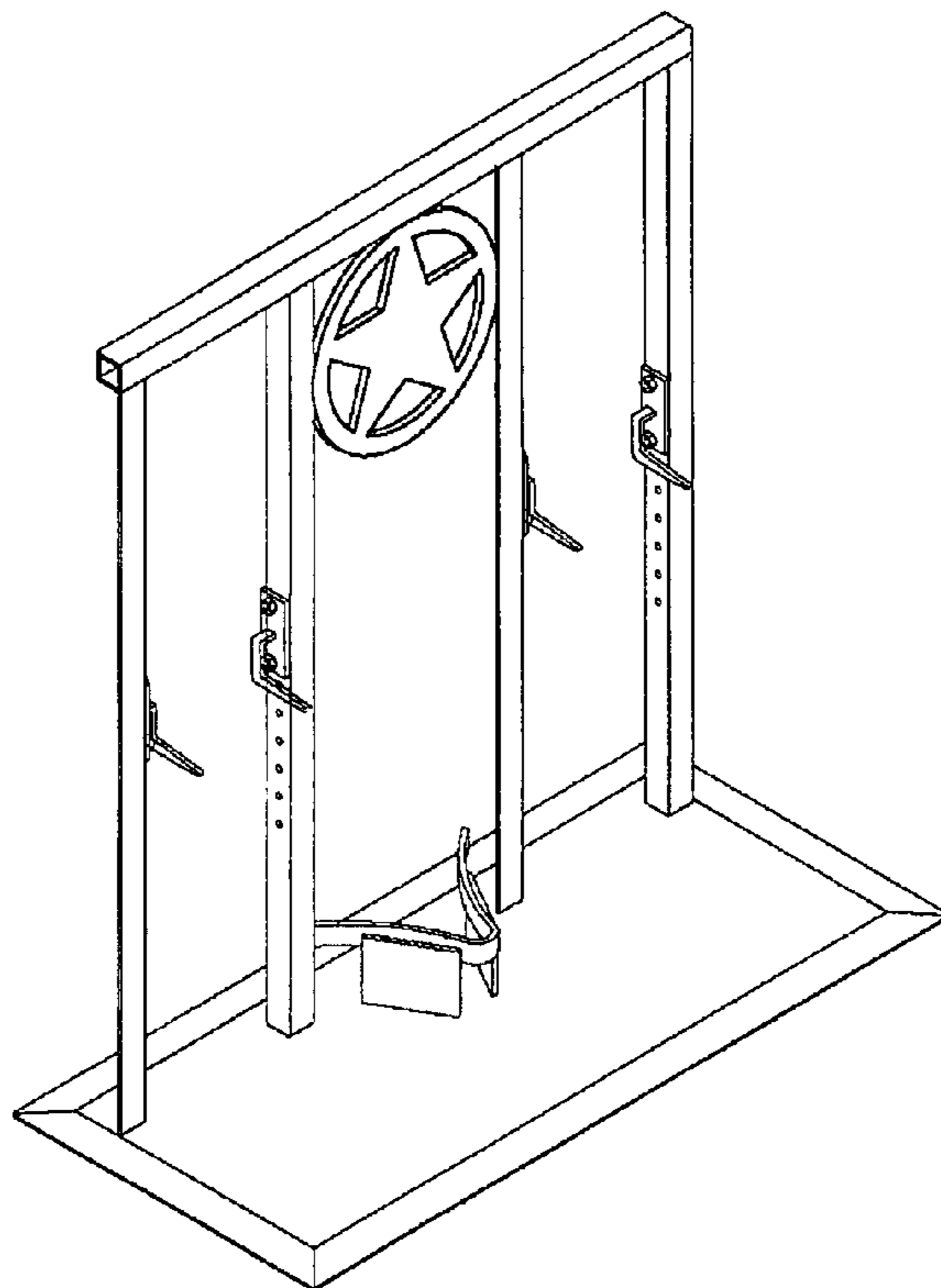

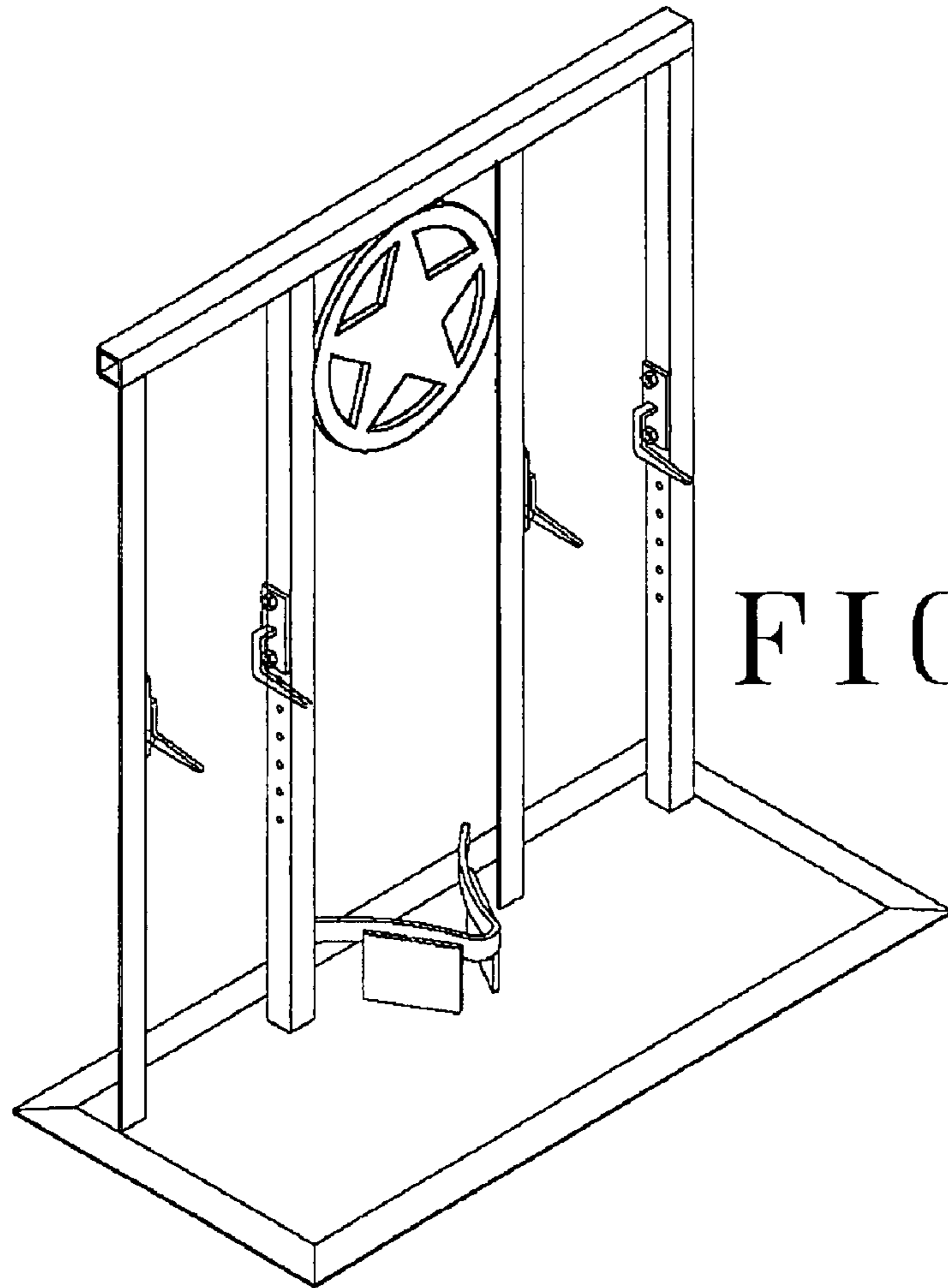

FIG. 1

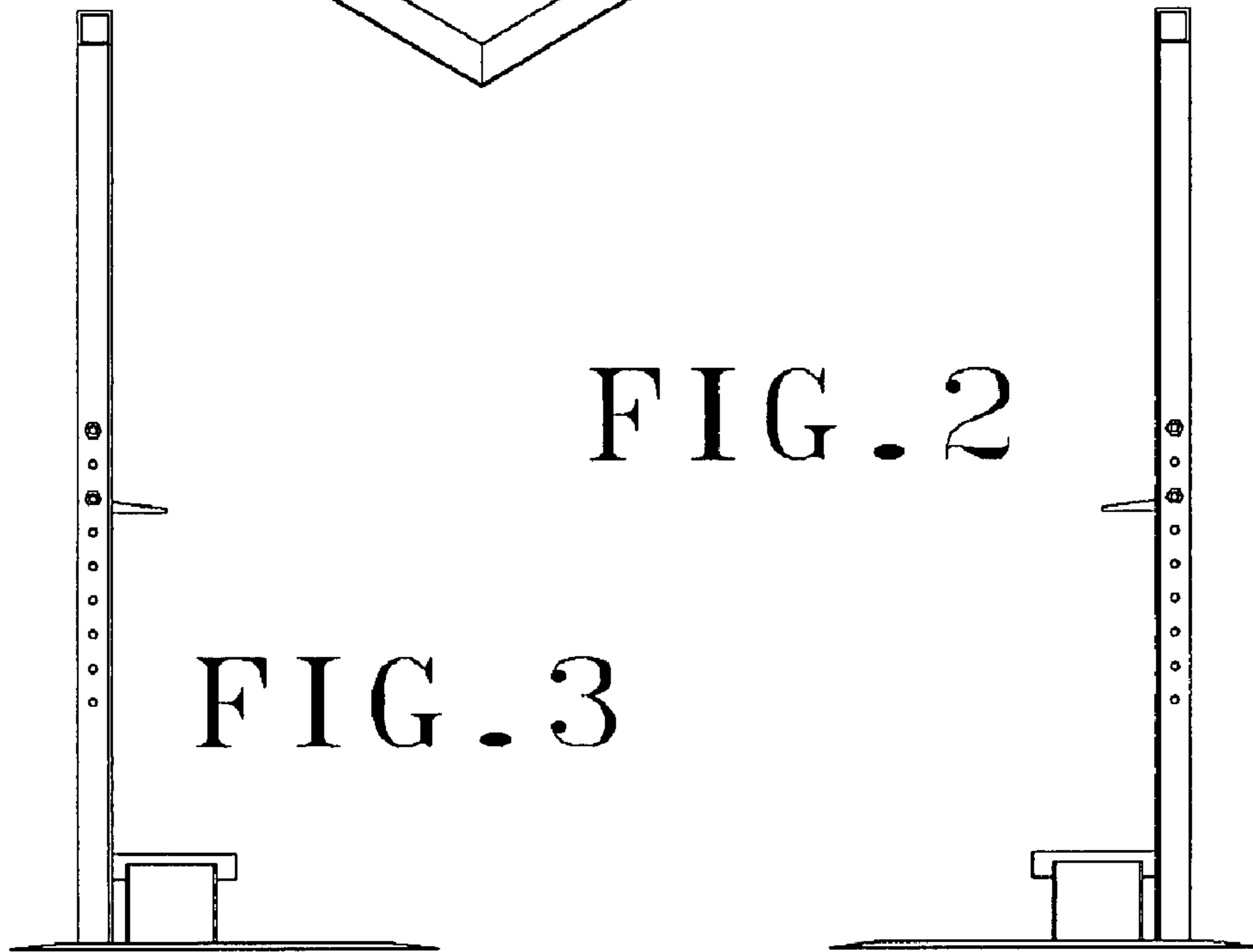

FIG. 2

FIG. 3

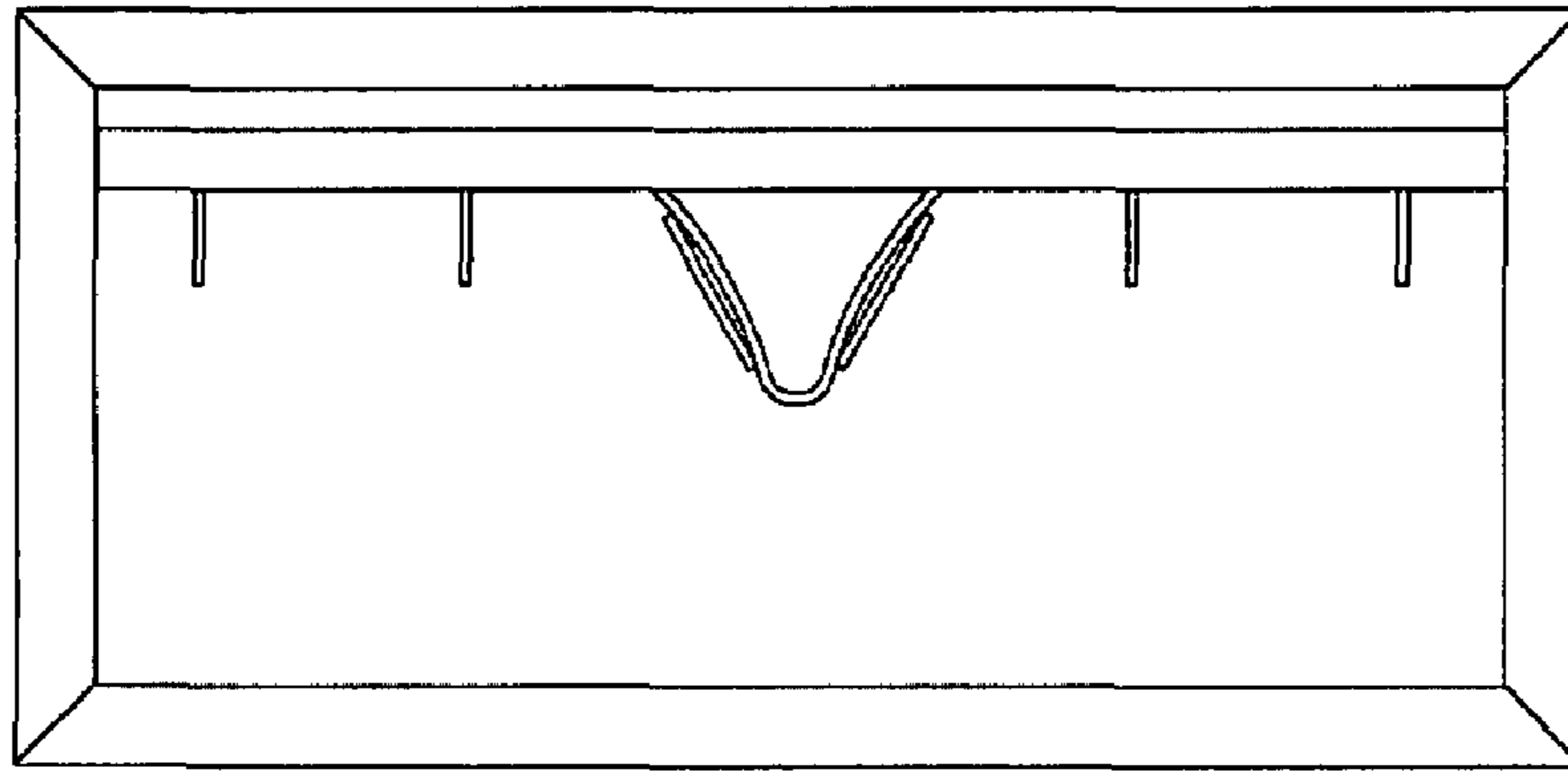

FIG. 4

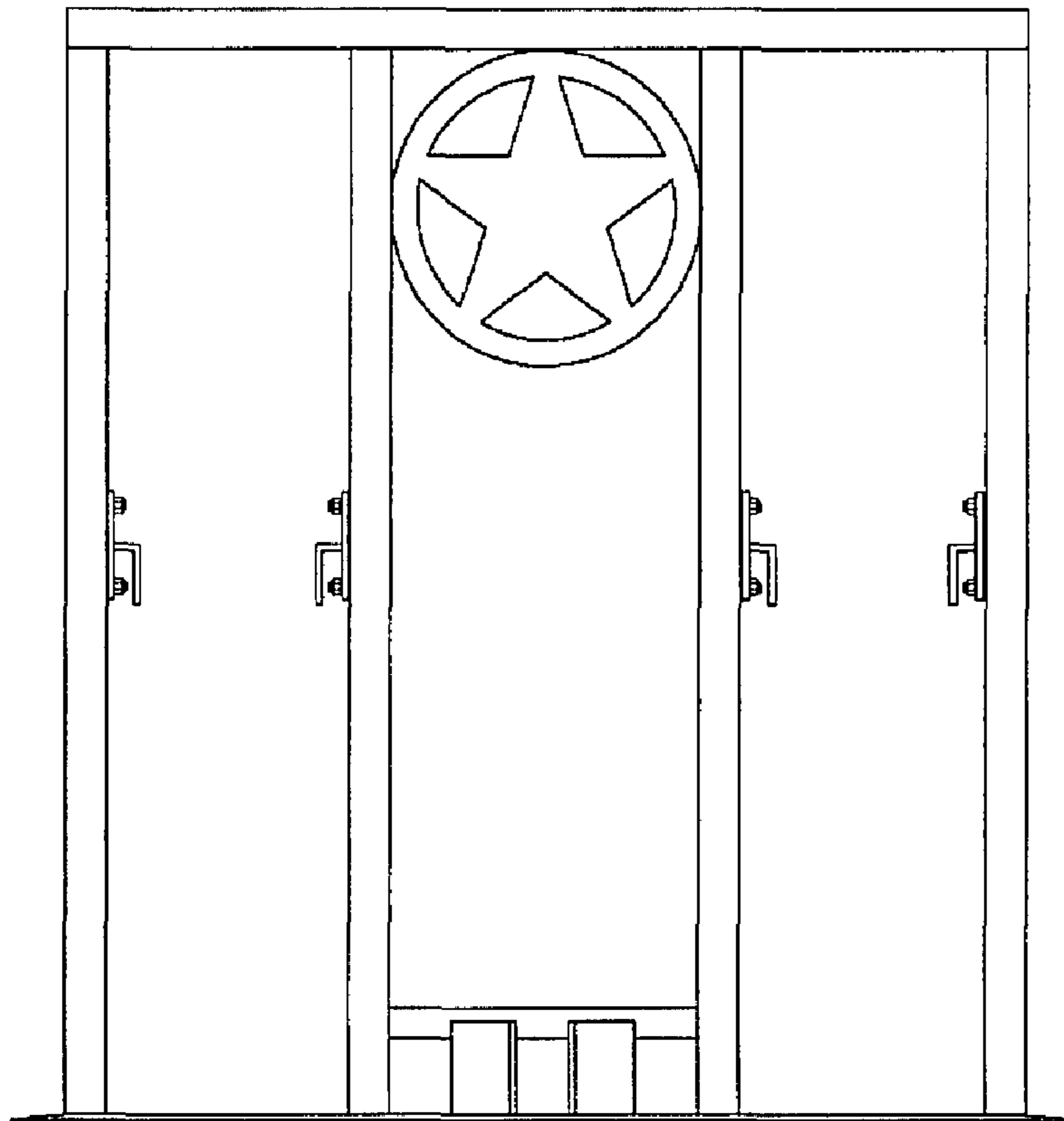

FIG. 5

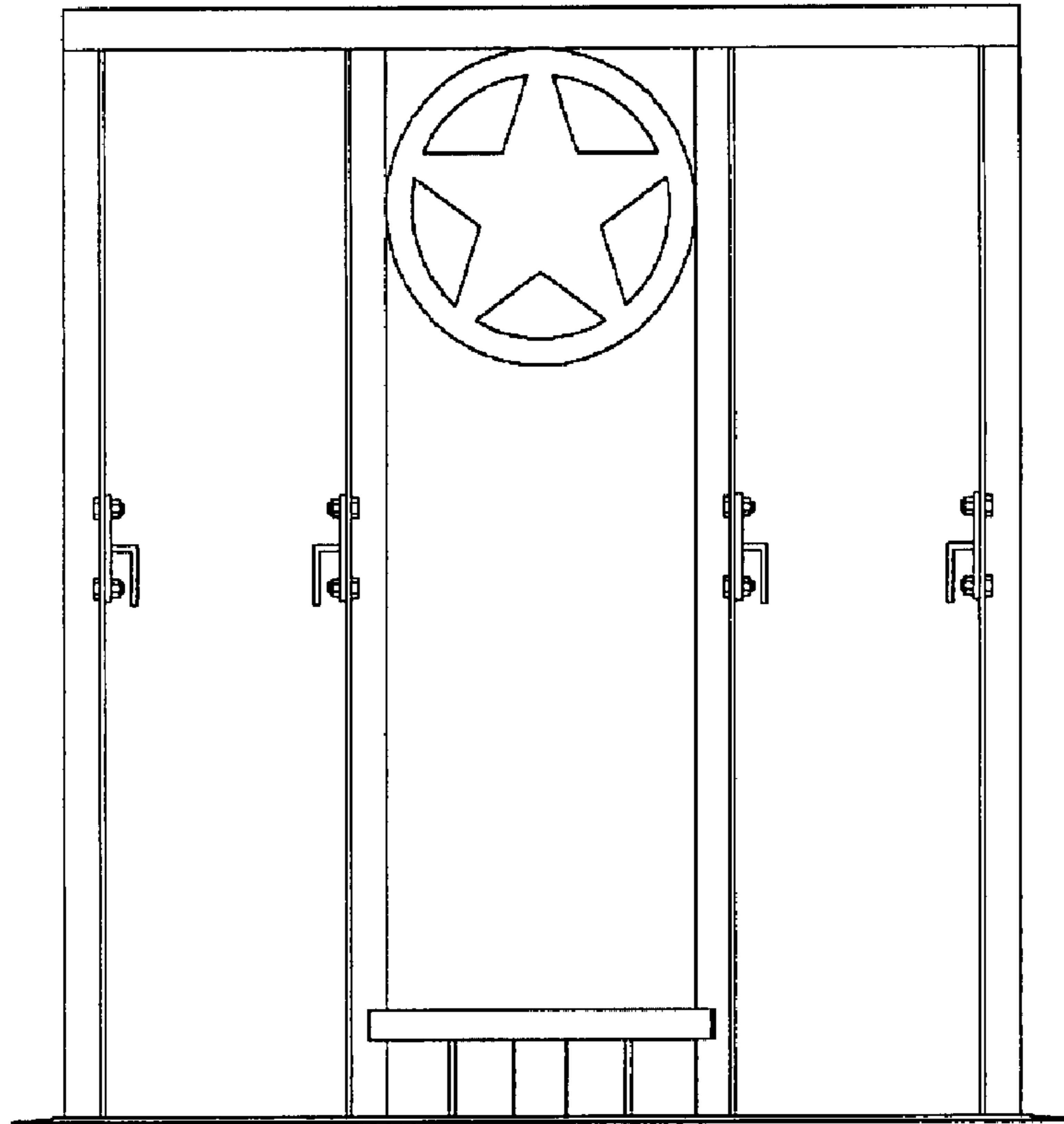

FIG. 6

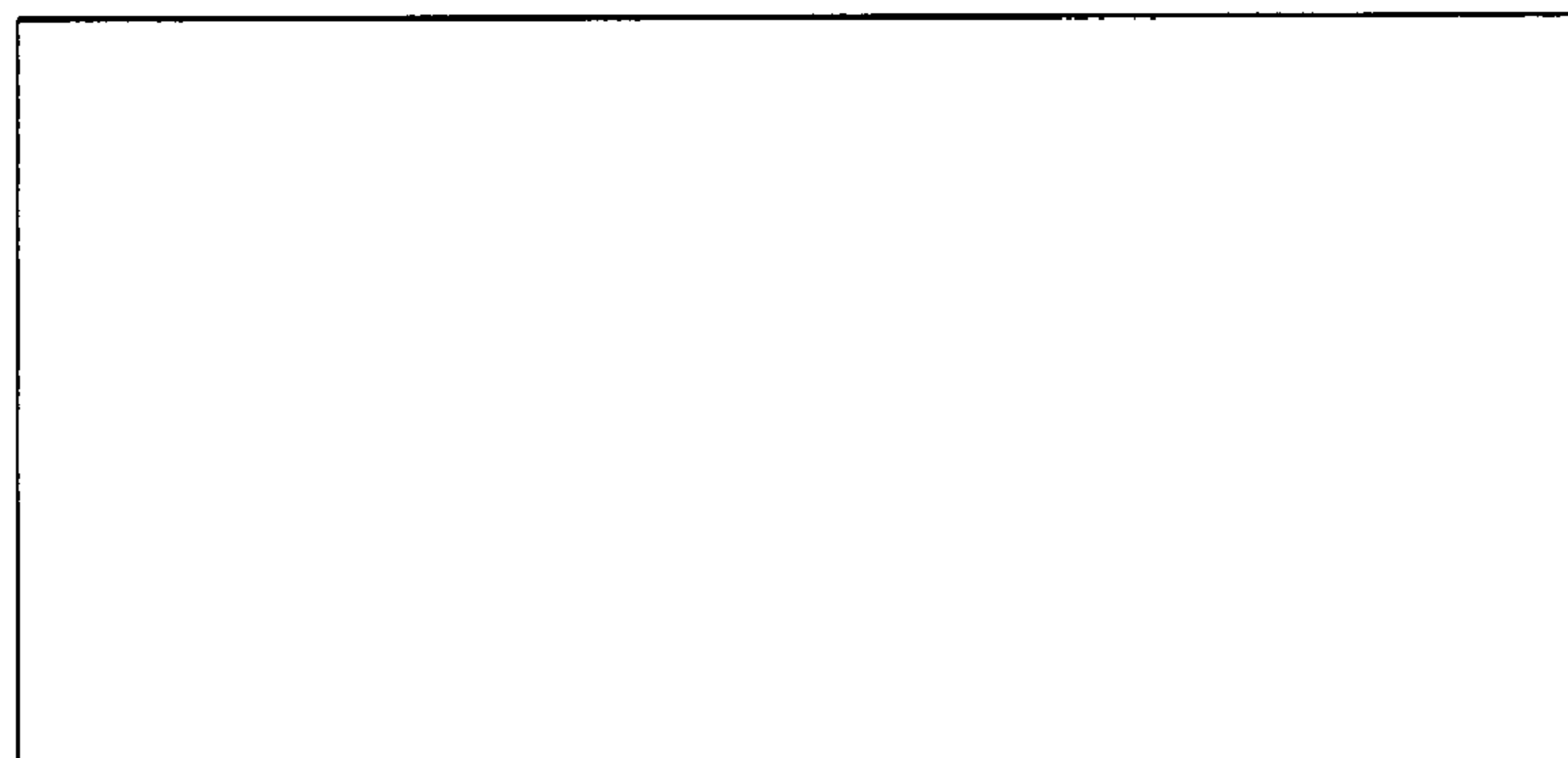

FIG. 7