



US00D648895S

(12) **United States Design Patent**
Ino

(10) **Patent No.:** **US D648,895 S**

(45) **Date of Patent:** **** Nov. 15, 2011**

(54) **ELECTRIC SHAVER**

(75) Inventor: **Tomoaki Ino**, Yokohama (JP)

(73) Assignee: **Panasonic Electric Works Co., Ltd.**,
Kadoma-shi (JP)

(**) Term: **14 Years**

(21) Appl. No.: **29/396,240**

(22) Filed: **Jun. 28, 2011**

(30) **Foreign Application Priority Data**

Feb. 18, 2011 (JP) 2011-003368

(51) **LOC (9) Cl.** **28-03**

(52) **U.S. Cl.** **D28/49**

(58) **Field of Classification Search** 30/32, 34.05,
30/34.1-34.2, 30-31, 43-43.92, 44-45, 47-51,
30/77-84, 526-541, 346.5-346.61, 194-196,
30/198-205, 208-216, 233-233.5; D28/44-44.1,
D28/45-54

See application file for complete search history.

(56) **References Cited**

U.S. PATENT DOCUMENTS

D549,874 S *	8/2007	Nishizawa	D28/51
D571,956 S *	6/2008	Nishizawa	D28/49
D572,408 S *	7/2008	Nishizawa	D28/49
D590,543 S *	4/2009	Ullmann	D28/49
D621,097 S *	8/2010	Nishizawa	D28/51
D623,353 S *	9/2010	Nishizawa	D28/52

2006/0265880 A1 *	11/2006	Sagawa	30/43.92
2008/0016694 A1 *	1/2008	Sato et al.	30/43.92
2008/0134514 A1 *	6/2008	Iwasaki et al.	30/43.91

* cited by examiner

Primary Examiner — Jennifer Rivard

(74) *Attorney, Agent, or Firm* — Marvin A. Motsenbocker;
Mots Law, PLLC

(57) **CLAIM**

The ornamental design for an electric shaver, as shown and described.

DESCRIPTION

FIG. 1 is a front perspective view of an electric shaver;
FIG. 2 is a front view thereof;
FIG. 3 is a right side view thereof;
FIG. 4 is a top plan view thereof;
FIG. 5 is a rear view thereof;
FIG. 6 is a left side view thereof;
FIG. 7 is a bottom plan view thereof;
FIG. 8 is a sectional view thereof taken along line 8-8 in FIG. 2, in which the internal components are omitted;
FIG. 9 is an end view thereof taken along line 9-9 in FIG. 2, in which the internal components are omitted; and,
FIG. 10 is an end view thereof taken along line 10-10 in FIG. 2, in which the internal components are omitted.

The portions of the article in broken lines are shown for illustrative purposes only and form no part of the claimed design.

1 Claim, 10 Drawing Sheets

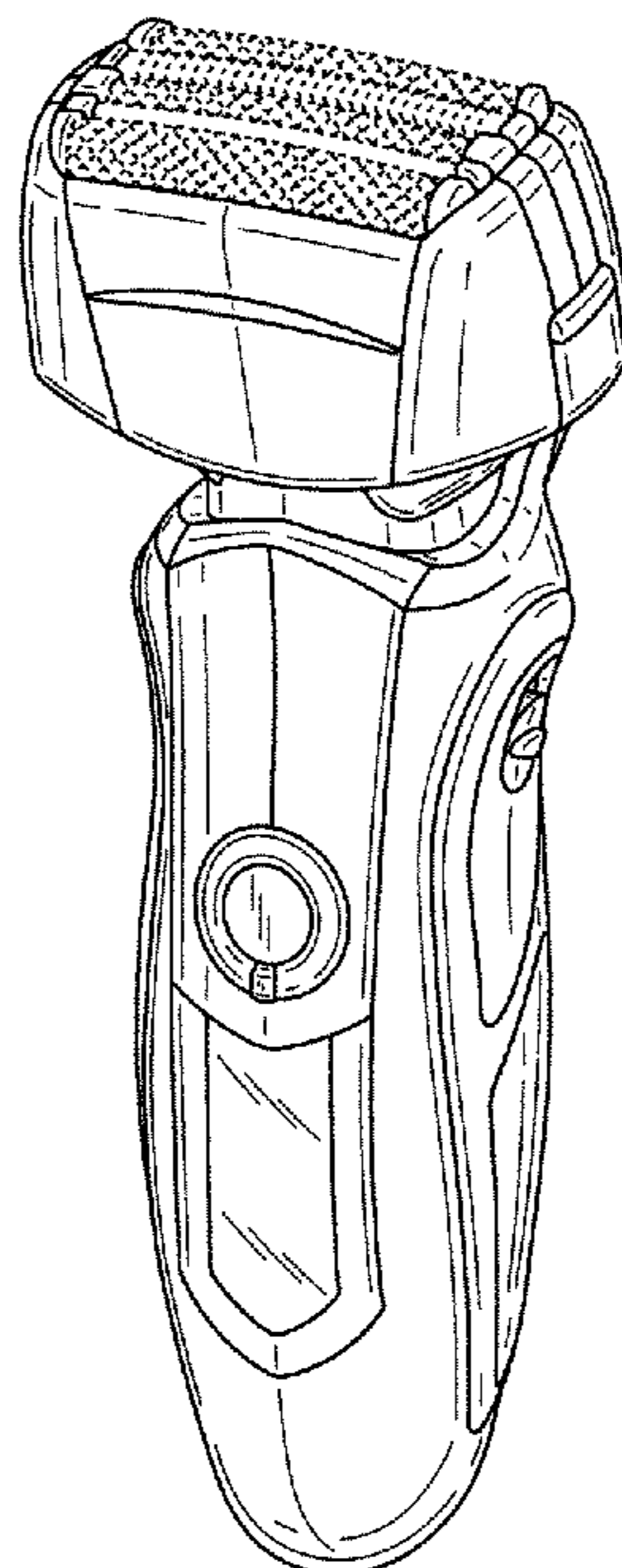

Fig. 1

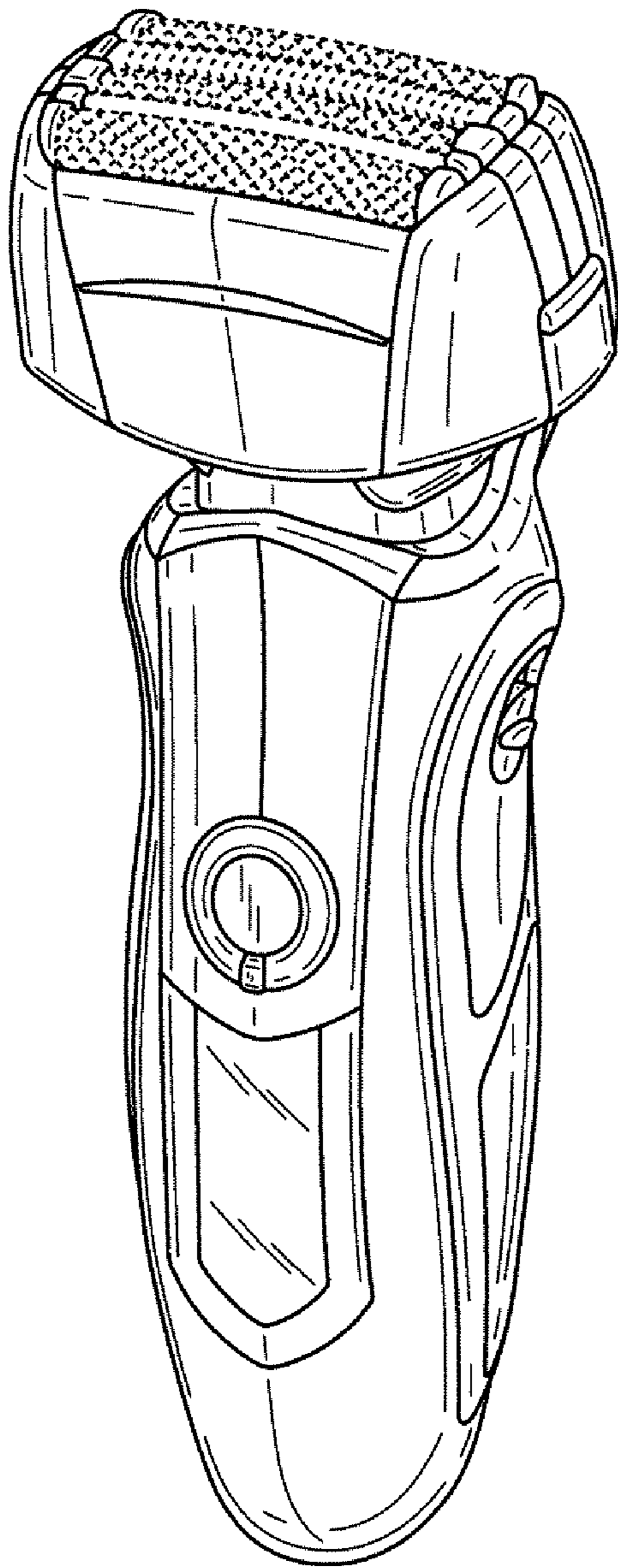

Fig.2

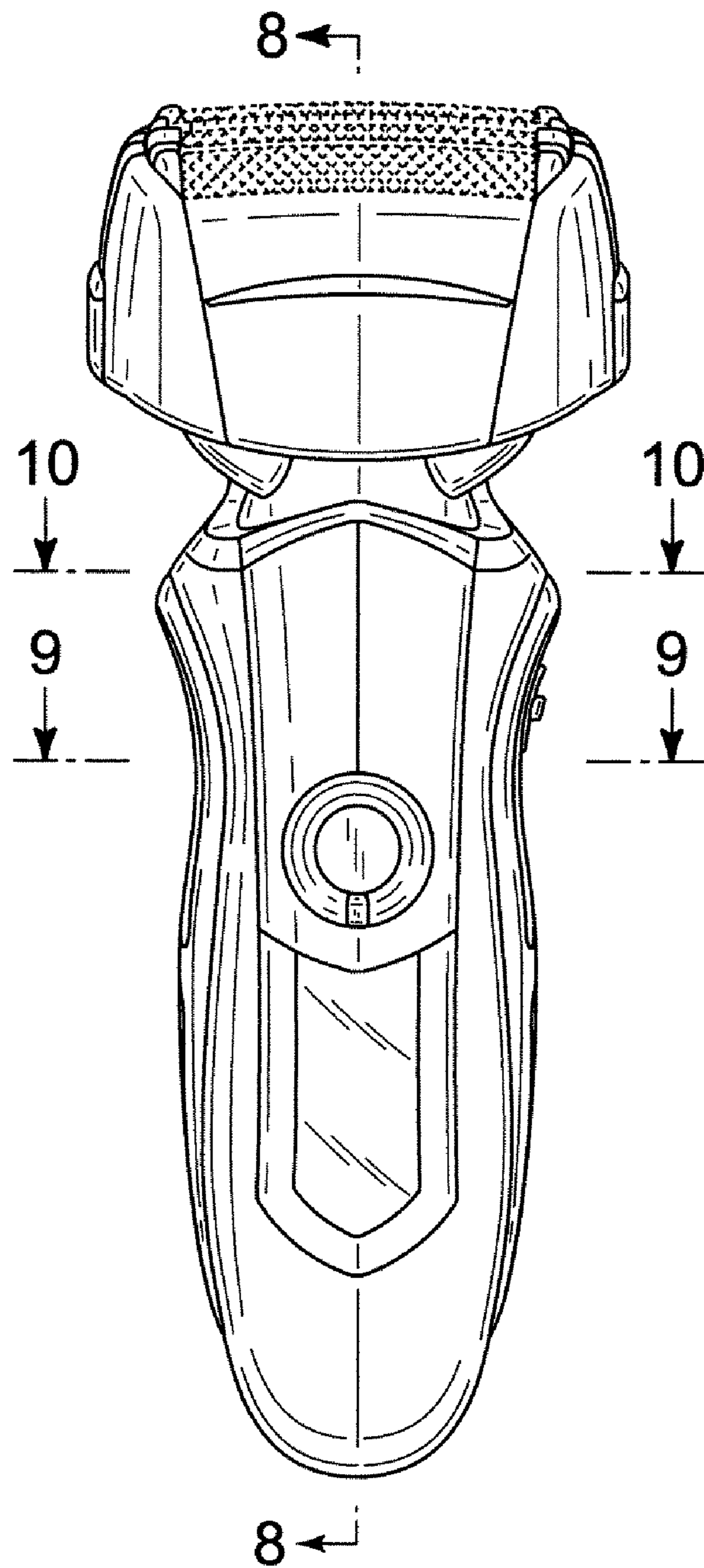

Fig.3

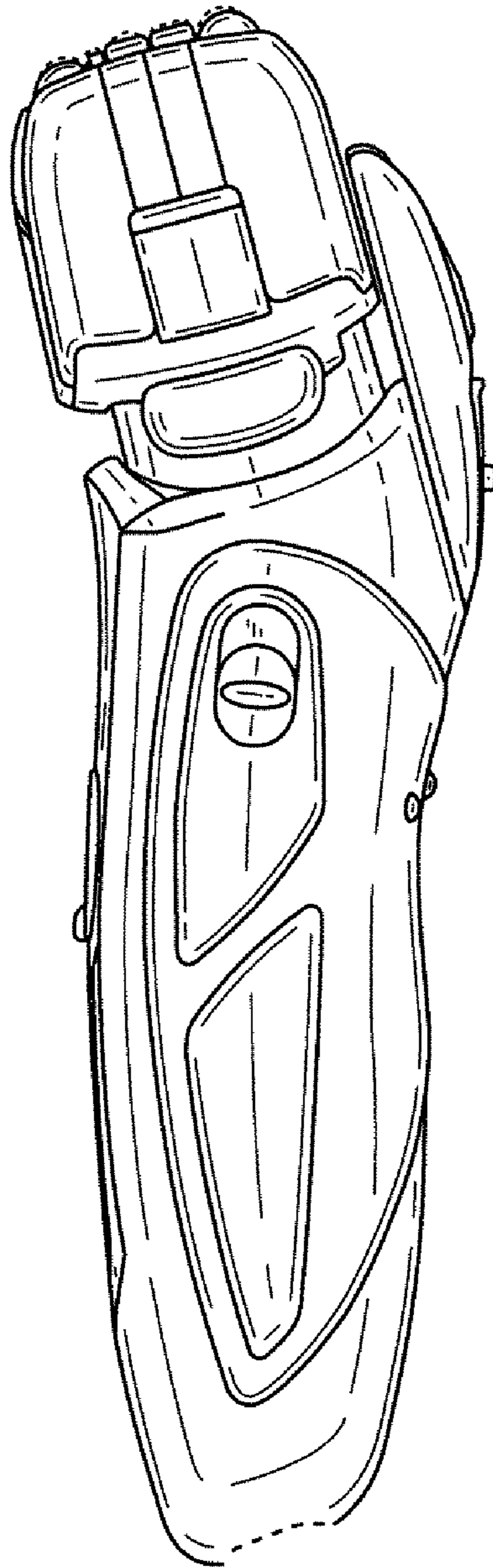

Fig.4

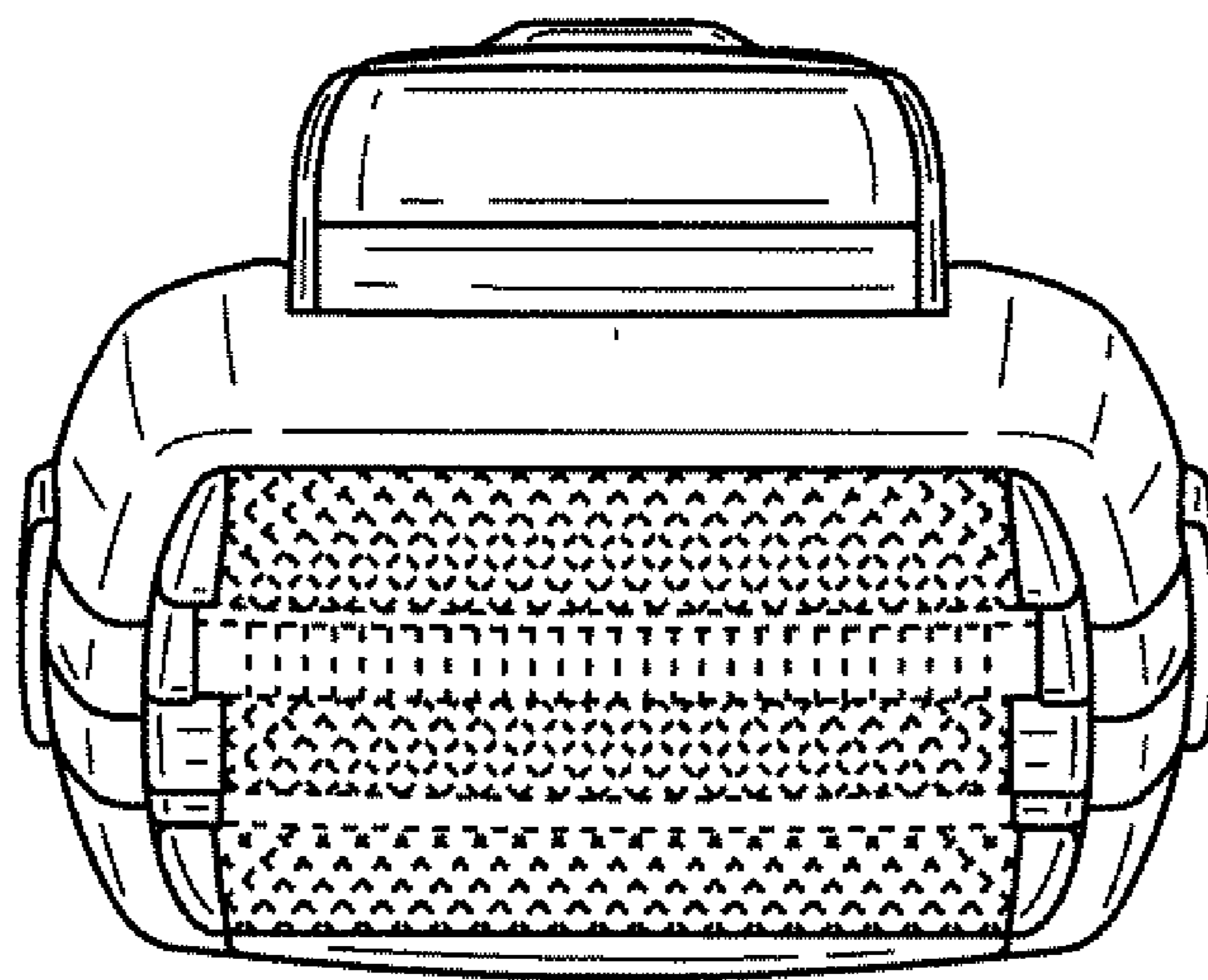

Fig.5

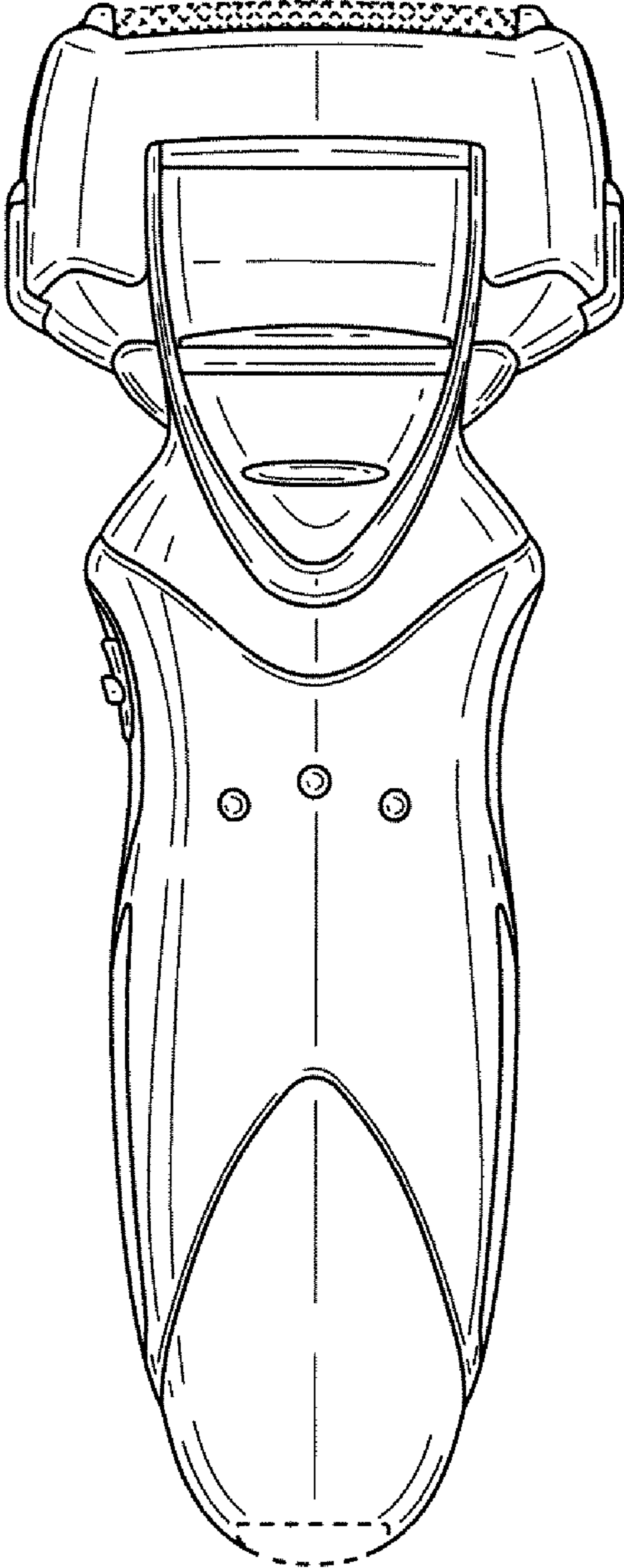

Fig.6

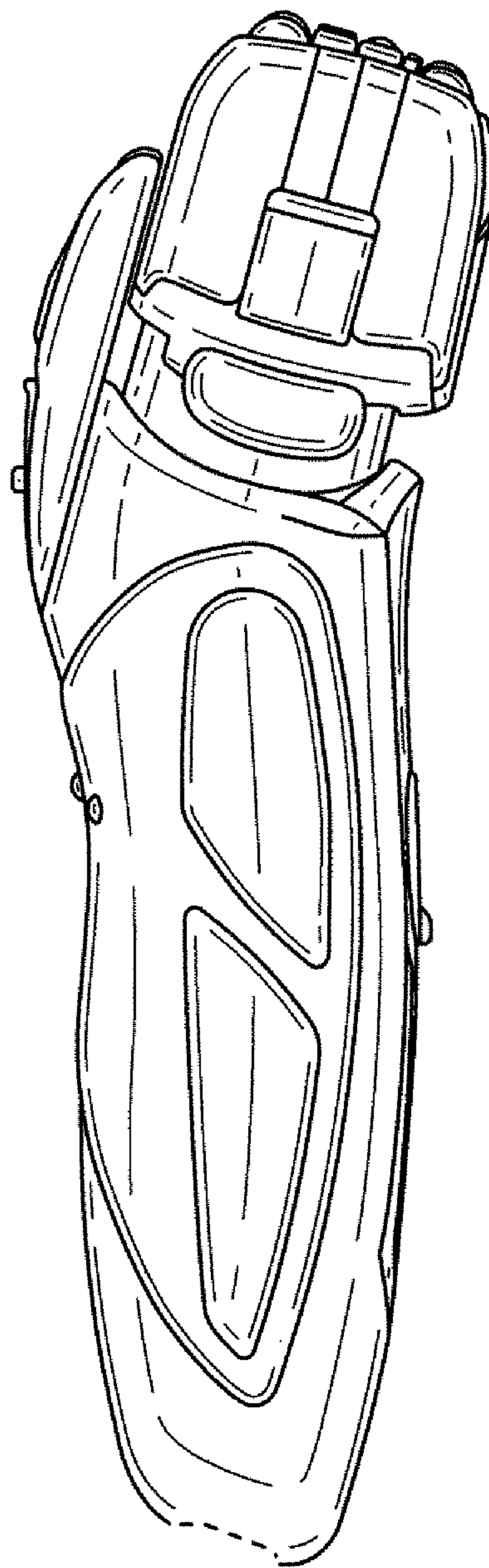

Fig. 7

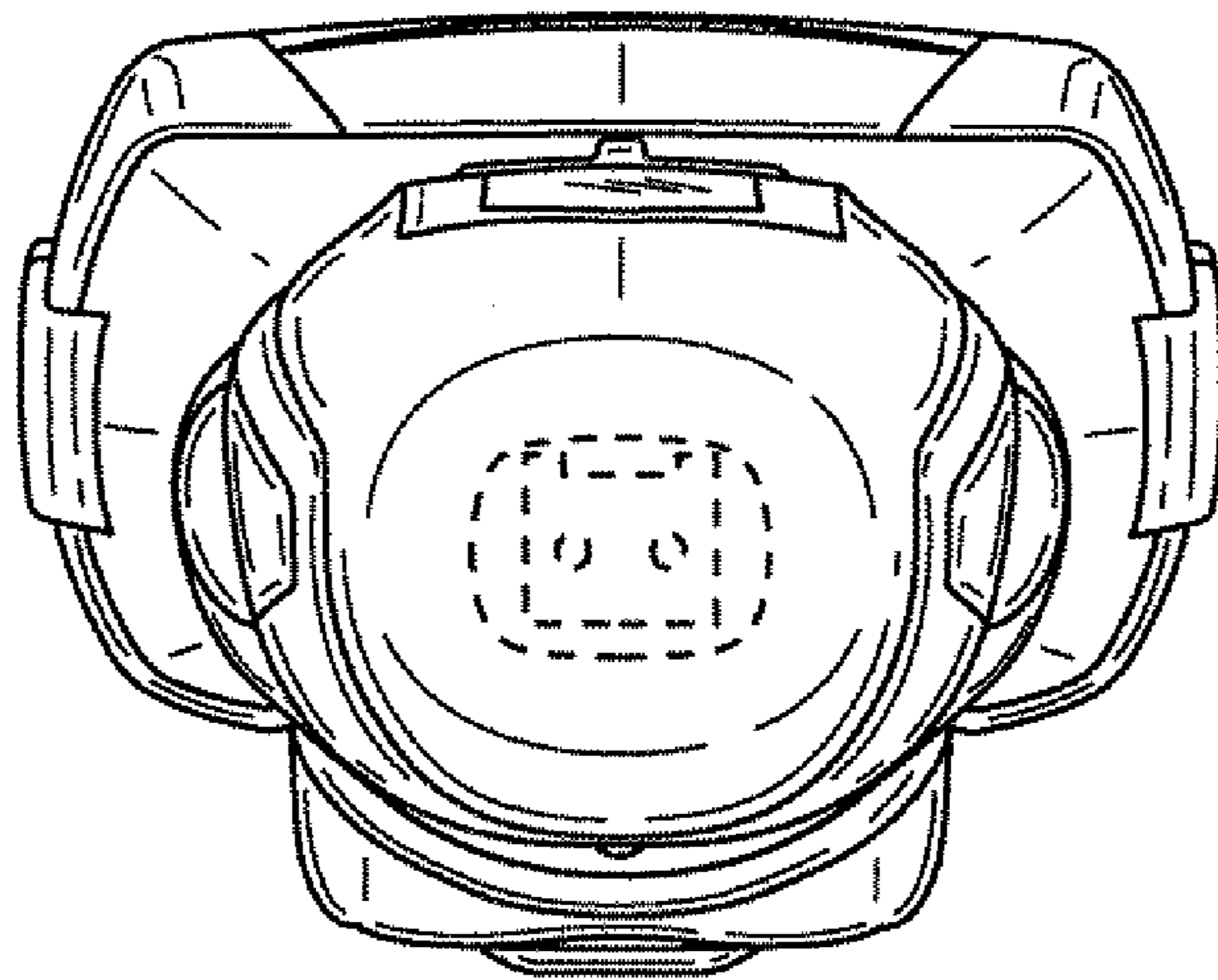

Fig.8

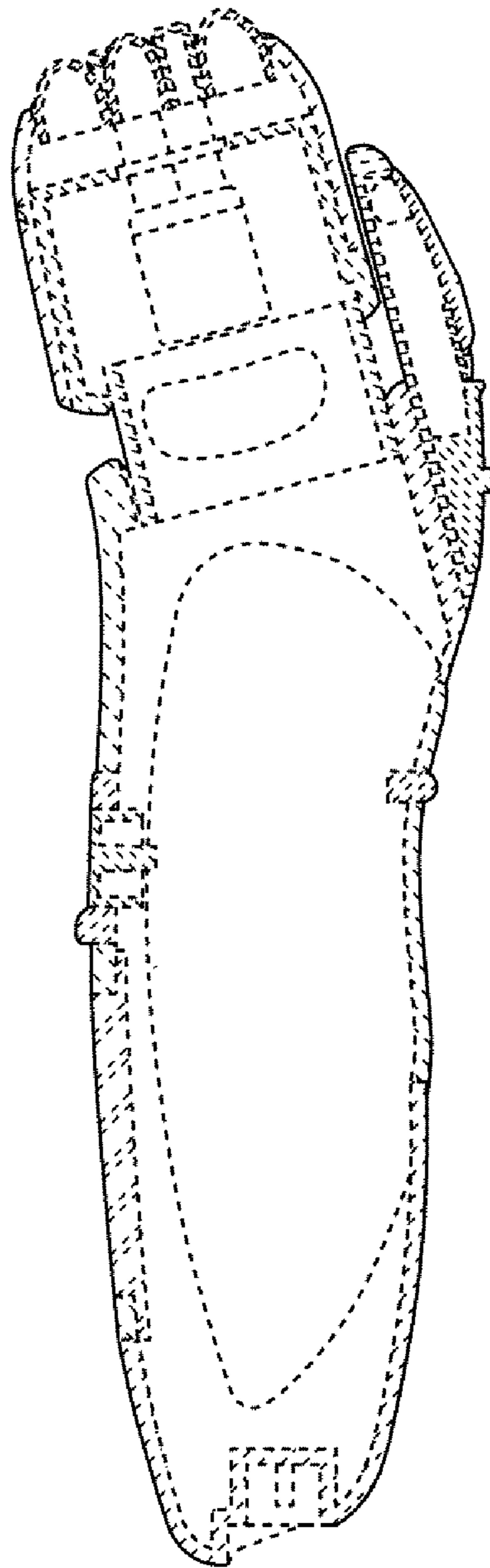

Fig. 9

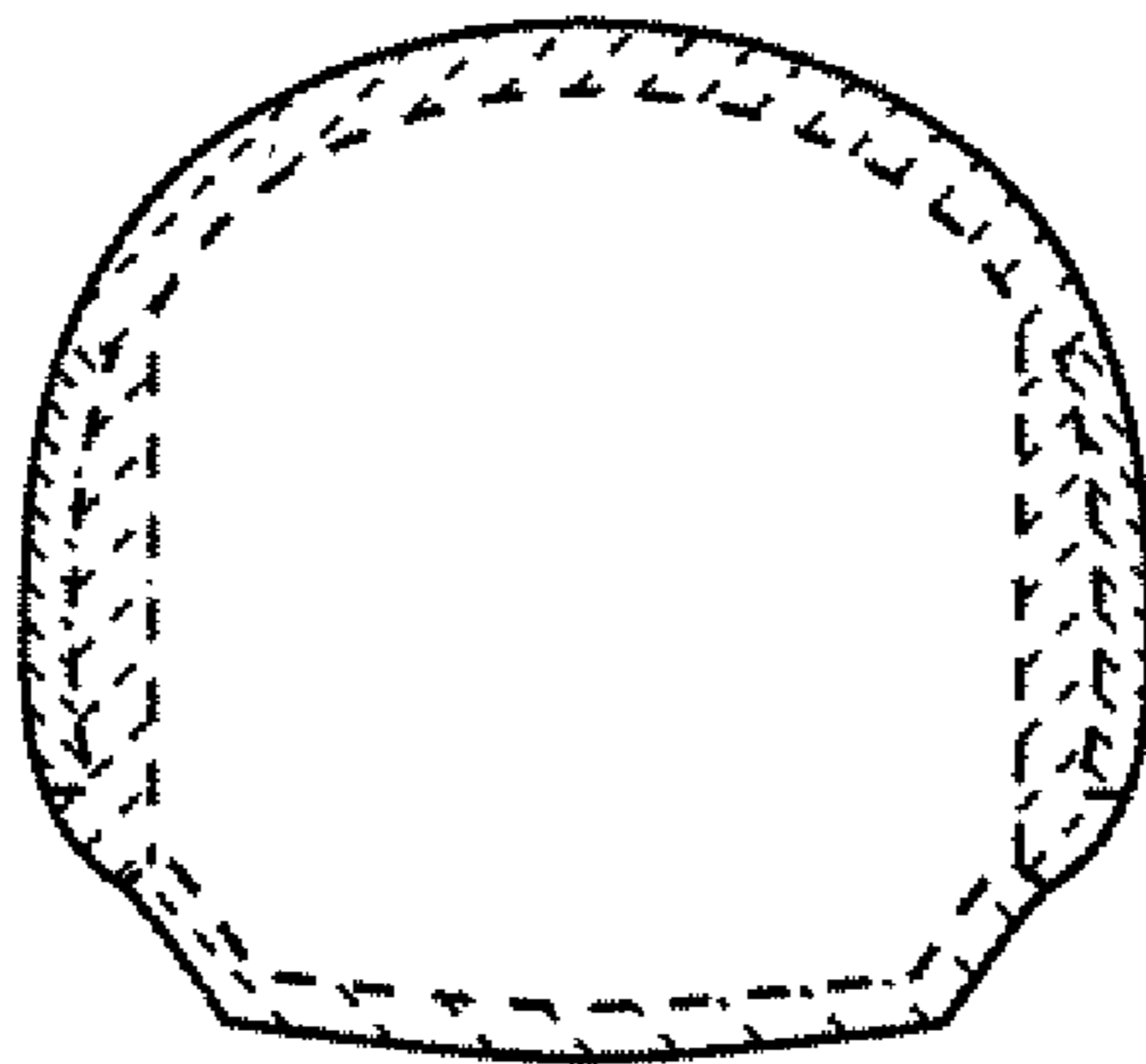

Fig. 10

