



US00D648893S

(12) **United States Design Patent**
Kaizuka

(10) **Patent No.:** **US D648,893 S**

(45) **Date of Patent:** **** Nov. 15, 2011**

(54) **HOT ROLL BRUSH**

(75) Inventor: **Kazutoshi Kaizuka**, Fukuoka (JP)

(73) Assignee: **Create Co., Ltd.**, Fukuoka (JP)

(**) Term: **14 Years**

(21) Appl. No.: **29/397,827**

(22) Filed: **Jul. 21, 2011**

(30) **Foreign Application Priority Data**

Apr. 4, 2011 (JP) 2011-009243

(51) **LOC (9) Cl.** **28-03**

(52) **U.S. Cl.** **D28/35**

(58) **Field of Classification Search** D28/35-38;

131/223-272; 219/222, 225-226; D4/116

See application file for complete search history.

(56) **References Cited**

U.S. PATENT DOCUMENTS

D251,205 S *	2/1979	Ergaver et al.	D28/35
D269,298 S *	6/1983	Oberheim	D28/35
D294,527 S *	3/1988	Oberheim	D28/35
D313,871 S *	1/1991	Oberheim	D28/35
D314,064 S *	1/1991	Ho	D28/35
D334,666 S *	4/1993	Bell et al.	D28/35
D441,137 S *	4/2001	McCurrach	D28/35

D455,861 S *	4/2002	McCurrach	D28/35
D556,948 S *	12/2007	Leung	D28/35
7,478,640 B2 *	1/2009	Saida et al.	132/228
D607,603 S *	1/2010	Schmitz	D28/35
D608,947 S *	1/2010	Schmitz	D28/35
2011/0114111 A1 *	5/2011	Guthans	132/211

OTHER PUBLICATIONS

Create Catalog, Feb. 2011.

* cited by examiner

Primary Examiner — Jennifer Rivard

(74) *Attorney, Agent, or Firm* — Warner Norcross & Judd LLP

(57) **CLAIM**

The ornamental design for a hot roll brush, as shown and described.

DESCRIPTION

FIG. 1 is a front perspective view of the current embodiment of a hot roll brush embodying the new design;

FIG. 2 is a top view thereof;

FIG. 3 is a right side view thereof and the left side view is a minor image thereof;

FIG. 4 is a bottom view thereof;

FIG. 5 is a left end view thereof; and,

FIG. 6 is a right end view thereof.

The broken lines shown in the drawings illustrate portions of the article and form no part of the claimed design.

1 Claim, 3 Drawing Sheets

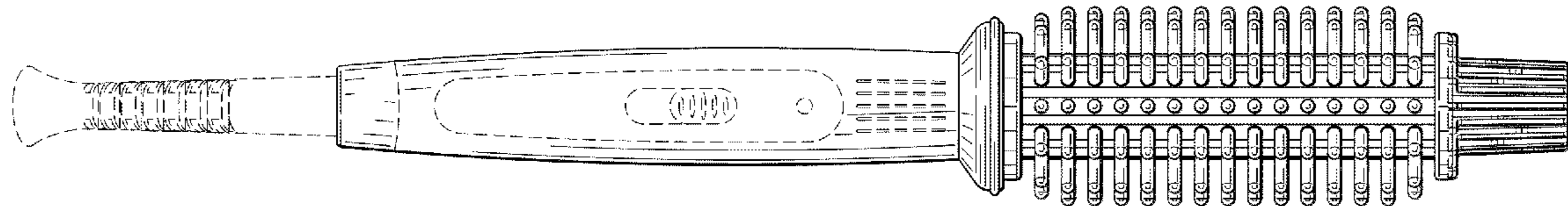

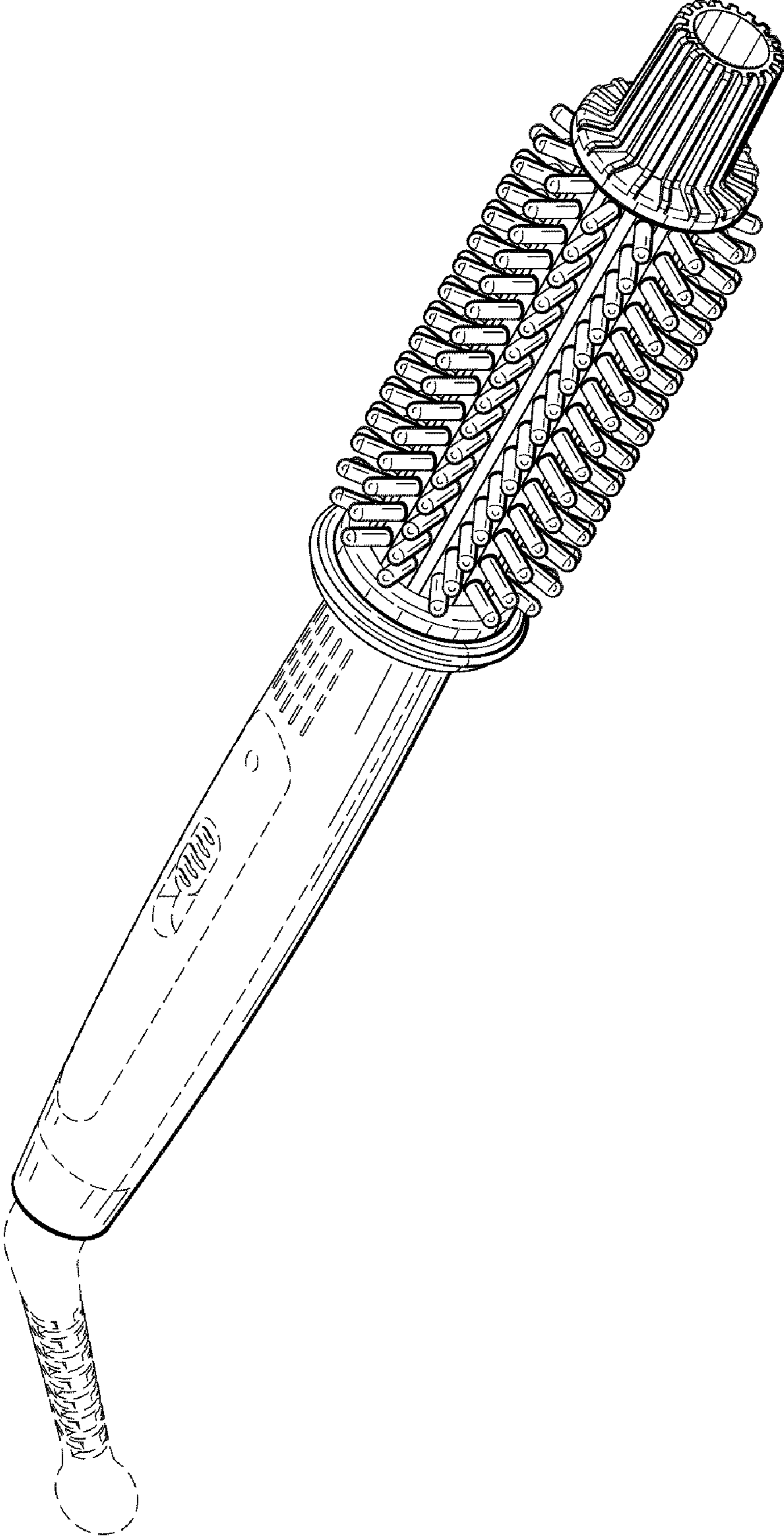

FIG. 1

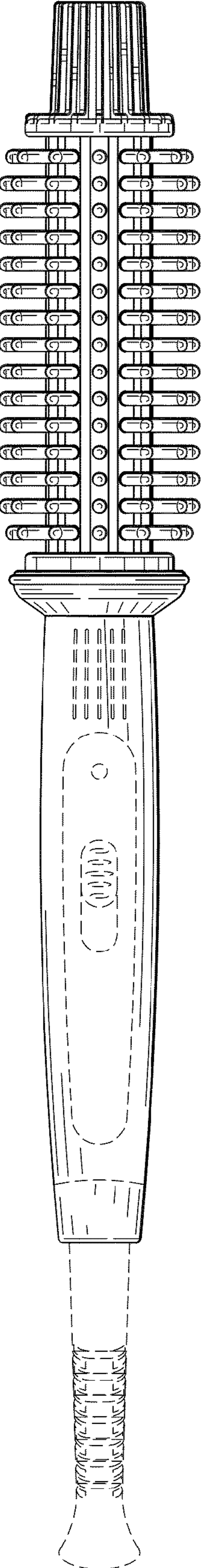

FIG. 2

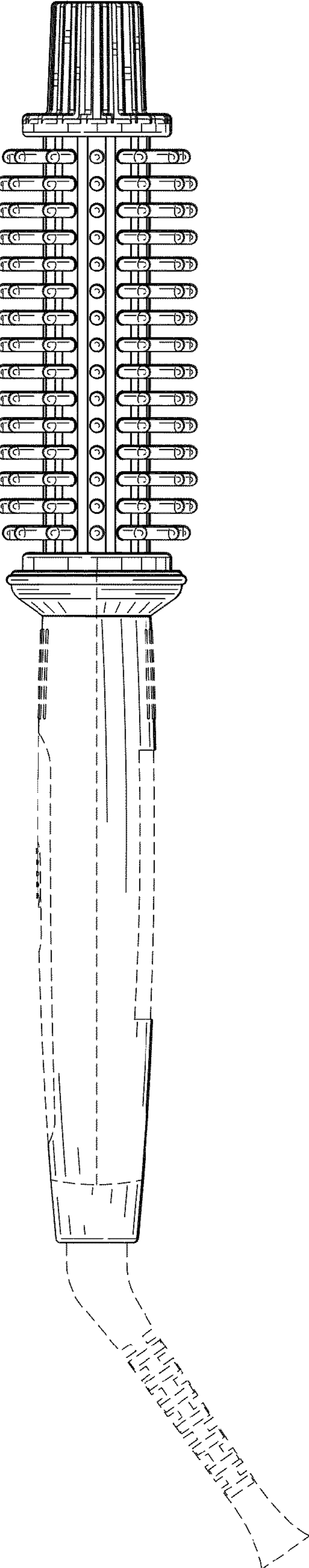

FIG. 3

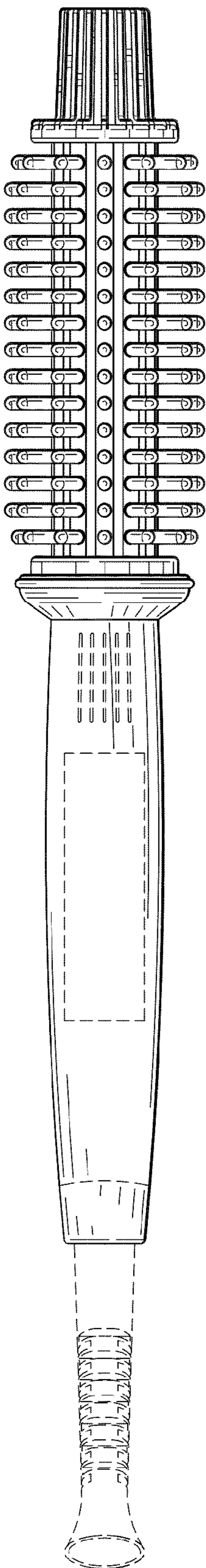

FIG. 4

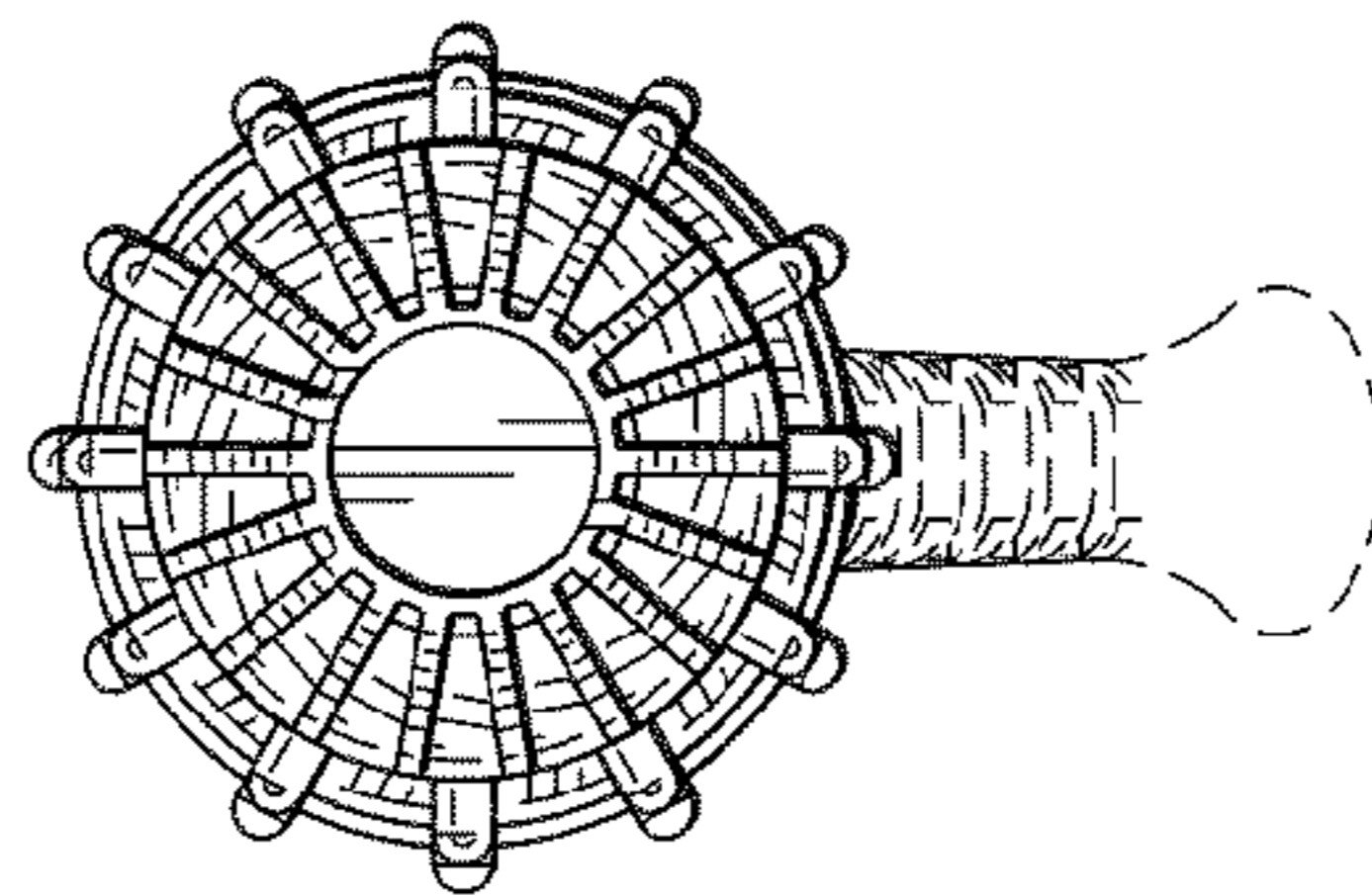

FIG. 6

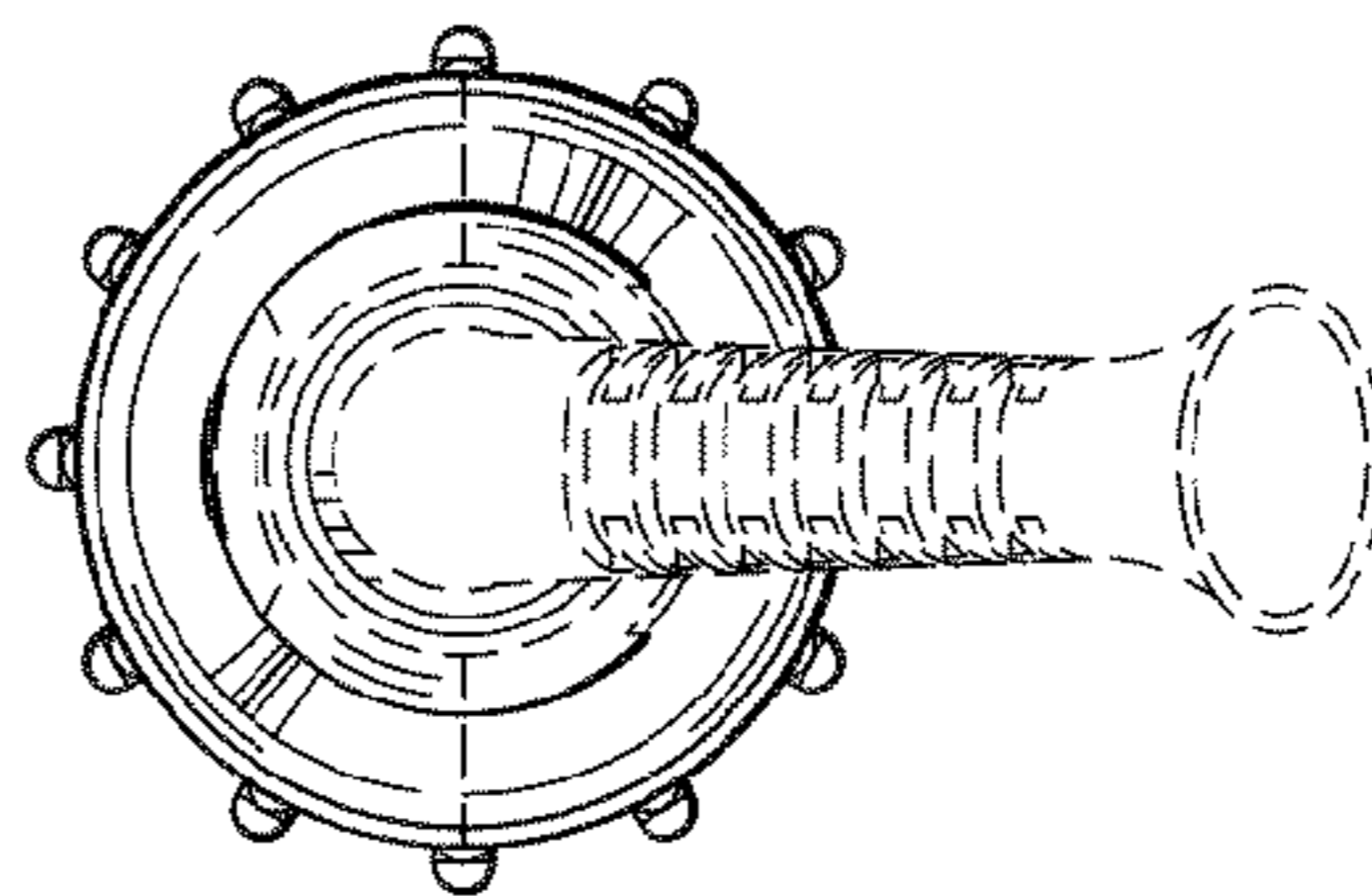

FIG. 5

UNITED STATES PATENT AND TRADEMARK OFFICE
CERTIFICATE OF CORRECTION

PATENT NO. : D648,893 S
APPLICATION NO. : 29/397827
DATED : November 15, 2011
INVENTOR(S) : Kazutoshi Kaizuka

Page 1 of 1

It is certified that error appears in the above-identified patent and that said Letters Patent is hereby corrected as shown below:

On the title page, under item (57), in the Description, Fig. 3, Line 2:

“minor” should be --mirror--

Signed and Sealed this
Third Day of January, 2012

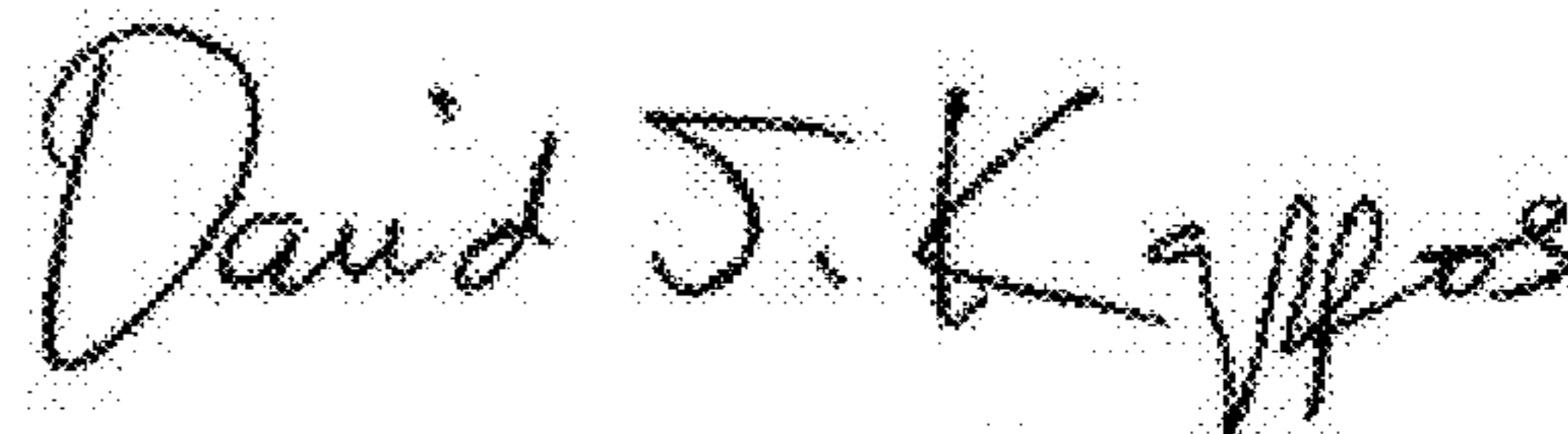
A handwritten signature in black ink that reads "David J. Kappos". The signature is written in a cursive style with a large initial "D" and "K".

David J. Kappos
Director of the United States Patent and Trademark Office