



US00D648822S

(12) **United States Design Patent**
Salvador et al.

(10) **Patent No.:** **US D648,822 S**

(45) **Date of Patent:** **** Nov. 15, 2011**

- (54) **FUEL FILTER**
- (75) Inventors: **Christopher J. Salvador**, Peoria, IL (US); **Randall W. Heibenthal**, Mahomet, IL (US); **Dennis M. Deedrich**, Champaign, IL (US); **David B. Harder**, Burnsville, MN (US); **John R. Hacker**, Minneapolis, MN (US); **Richard J. Eisenmenger**, Philo, IL (US)
- (73) Assignees: **Caterpillar Inc.**, Peoria, IL (US); **Advanced Filtration Systems Inc.**, Champaign, IL (US); **Donaldson Company Inc.**, Bloomington, MN (US)

5,374,355 A	12/1994	Habiger et al.
5,458,767 A	10/1995	Stone
5,474,676 A	12/1995	Janik et al.
5,484,527 A	1/1996	Janik et al.
5,489,384 A	2/1996	Janik et al.
5,525,225 A	6/1996	Janik et al.
5,538,626 A	7/1996	Baumann
5,548,893 A	8/1996	Koelfgen
5,578,221 A	11/1996	Janik
5,584,987 A	12/1996	Mules
5,660,726 A	8/1997	Dluzik
5,660,729 A	8/1997	Baumann
5,660,771 A	8/1997	Dunfee et al.
5,685,985 A	11/1997	Brown et al.
5,688,396 A	11/1997	Baumann et al.

(Continued)

(**) Term: **14 Years**

FOREIGN PATENT DOCUMENTS

JP 09 173716 7/1994

(21) Appl. No.: **29/376,119**

(Continued)

(22) Filed: **Oct. 1, 2010**

Primary Examiner — Robin V Webster

(51) **LOC (9) Cl.** **23-01**

(74) *Attorney, Agent, or Firm* — Miller, Matthias & Hull

(52) **U.S. Cl.** **D23/209**

(58) **Field of Classification Search** D23/207,
D23/209, 365; 210/499, 497.1, 497.01, 493.1,
210/493.5, 238, 444

(57) **CLAIM**

The ornamental design for a fuel filter, as shown and described.

See application file for complete search history.

DESCRIPTION

(56) **References Cited**

U.S. PATENT DOCUMENTS

4,172,795 A	10/1979	Kurtz et al.
4,298,465 A	11/1981	Druffel
4,502,956 A	3/1985	Wilson et al.
4,906,365 A	3/1990	Baumann et al.
4,948,503 A	8/1990	Baumann et al.
5,035,797 A	7/1991	Janik
5,098,559 A	3/1992	Mack et al.
5,203,994 A	4/1993	Janik
5,300,223 A	4/1994	Wright
5,302,284 A	4/1994	Zeiner et al.
5,312,546 A	5/1994	Janik
5,342,519 A	8/1994	Friedmann et al.
5,366,400 A	11/1994	Kucik

FIG. 1 is a perspective view of our filter showing our new design;

FIG. 2 is a front view of the filter of FIG. 1;

FIG. 3 is a rear view of the filter of FIG. 1;

FIG. 4 is a left side view of the filter of FIG. 1;

FIG. 5 is a right side view of the filter of FIG. 1;

FIG. 6 is a top view of the filter of FIG. 1; and,

FIG. 7 is a bottom view of the filter of FIG. 1.

The broken lines depicted in the foregoing figures are for purposes of illustration only, and form no part of the claimed design.

1 Claim, 7 Drawing Sheets

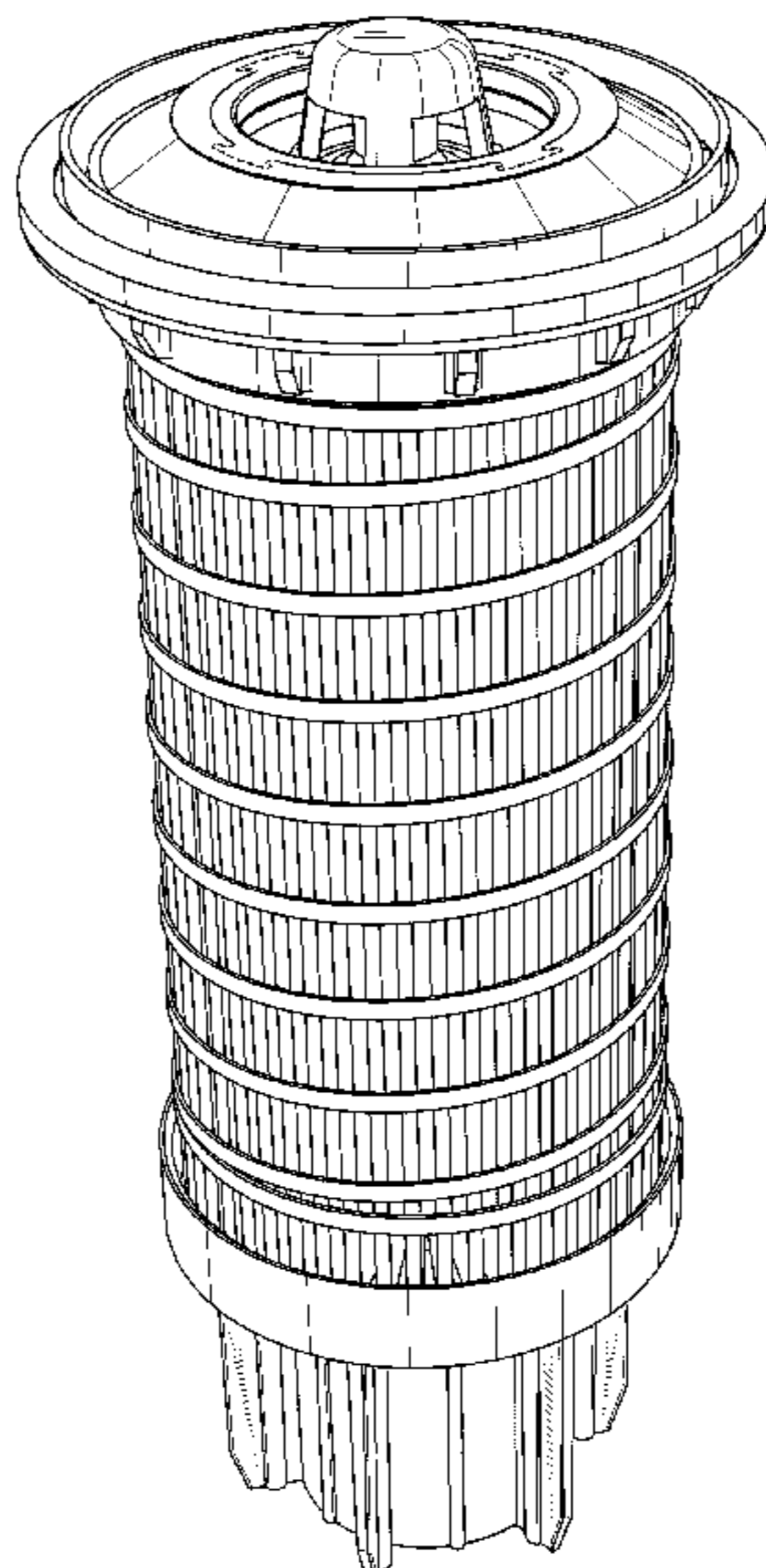

US D648,822 S

Page 2

U.S. PATENT DOCUMENTS

5,690,765 A * 11/1997 Stoyell et al. 156/69
 5,695,633 A 12/1997 Ernst et al.
 5,698,098 A 12/1997 Ernst et al.
 5,702,602 A 12/1997 Brown et al.
 5,718,825 A 2/1998 Greive et al.
 5,738,785 A 4/1998 Brown et al.
 5,753,116 A 5/1998 Baumann et al.
 5,770,054 A 6/1998 Ardes
 5,770,065 A 6/1998 Popoff et al.
 5,817,232 A 10/1998 Roll et al.
 5,858,227 A 1/1999 Stone et al.
 5,888,383 A 3/1999 Cox
 5,904,844 A 5/1999 Stone
 5,922,196 A 7/1999 Baumann
 5,922,199 A 7/1999 Hodgkins
 5,928,511 A 7/1999 Messner et al.
 5,935,481 A 8/1999 Dunfee et al.
 5,972,210 A 10/1999 Munkel
 D416,308 S * 11/1999 Ward et al. D23/209
 6,015,492 A 1/2000 Popoff et al.
 6,016,923 A 1/2000 Baumann
 6,021,905 A * 2/2000 Frejborg 209/411
 6,058,899 A 5/2000 Schetter
 6,068,762 A 5/2000 Stone et al.
 6,090,283 A 7/2000 Schumann et al.
 6,113,781 A 9/2000 Popoff et al.
 6,173,859 B1 1/2001 Schumann et al.
 6,174,438 B1 1/2001 Hodgkins et al.
 6,177,003 B1 1/2001 Jainek et al.
 6,224,758 B1 5/2001 Jainek et al.
 6,248,236 B1 6/2001 Hodgkins
 6,471,070 B2 10/2002 Janik
 6,485,637 B2 11/2002 Jainek et al.

D466,969 S * 12/2002 Druga D23/209
 6,506,302 B2 1/2003 Janik
 D470,216 S * 2/2003 Gustafson et al. D23/209
 6,514,404 B1 2/2003 Bauer
 6,517,710 B2 2/2003 Hartmann et al.
 6,569,326 B1 5/2003 Baumann et al.
 D476,058 S * 6/2003 Norton D23/209
 6,579,448 B2 6/2003 Dworatzek
 6,591,807 B1 7/2003 Ardes
 6,605,210 B2 8/2003 Reinhardt
 6,607,665 B2 8/2003 Fick et al.
 6,610,203 B1 8/2003 Jainek
 6,626,299 B1 9/2003 Brown et al.
 6,685,829 B1 2/2004 Baumann et al.
 6,709,588 B2 3/2004 Pavlin et al.
 6,740,234 B1 5/2004 Williams et al.
 6,972,092 B1 12/2005 Roll
 D524,611 S * 7/2006 Liu et al. D8/1
 D544,070 S * 6/2007 Flor et al. D23/209
 D560,751 S * 1/2008 Miller D23/209
 D571,433 S * 6/2008 Koteskey D23/209
 D609,775 S * 2/2010 Zukor D23/209
 7,771,595 B2 * 8/2010 Reynolds et al. 210/232
 2002/0158006 A1 10/2002 Thomas
 2003/0098269 A1 5/2003 Ardes
 2003/0226790 A1 12/2003 Brown et al.
 2003/0226800 A1 12/2003 Brown et al.
 2006/0118476 A1 6/2006 Weindorf et al.
 2008/0308481 A1 12/2008 Wieczorek et al.

FOREIGN PATENT DOCUMENTS

WO WO-2008/157597 12/2008

* cited by examiner

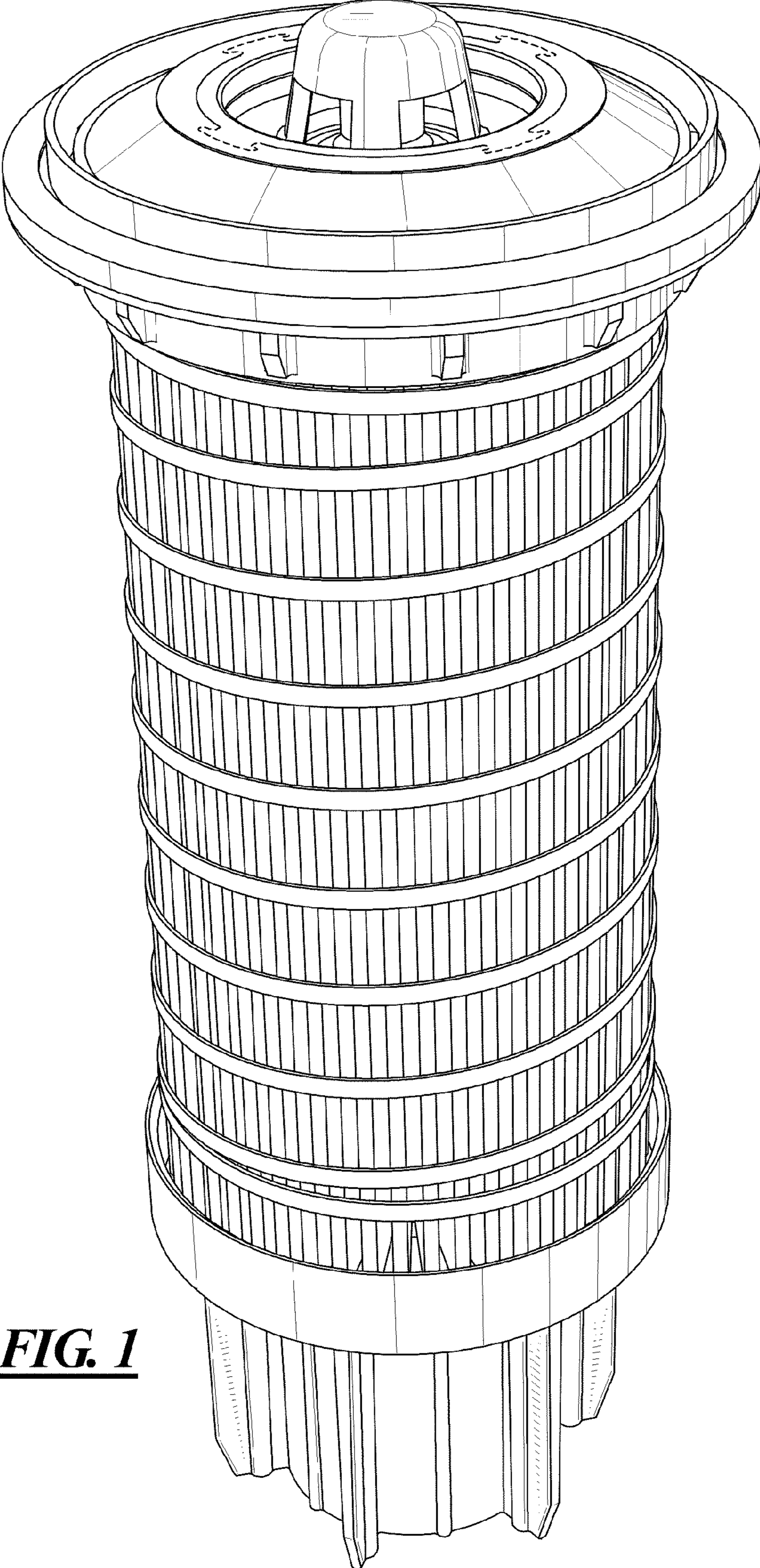

FIG. 1

FIG. 2

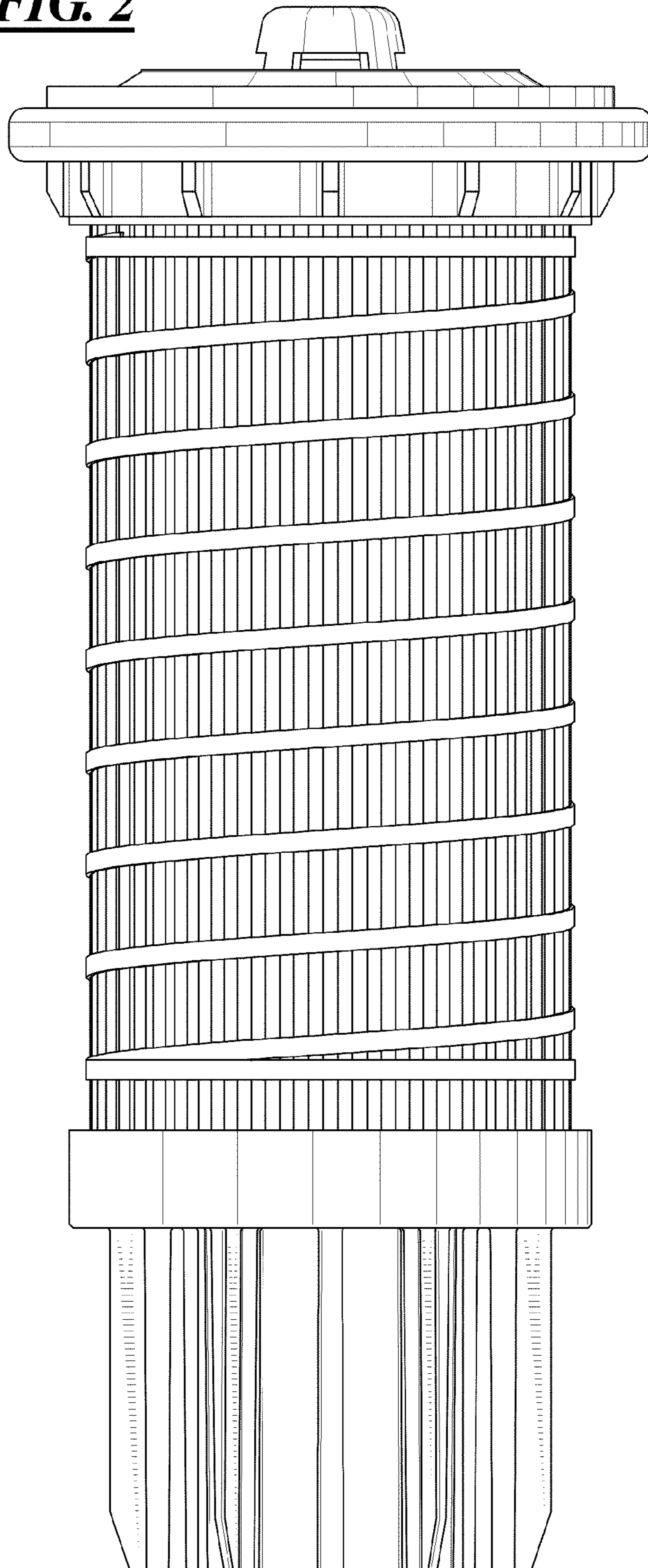

FIG. 3

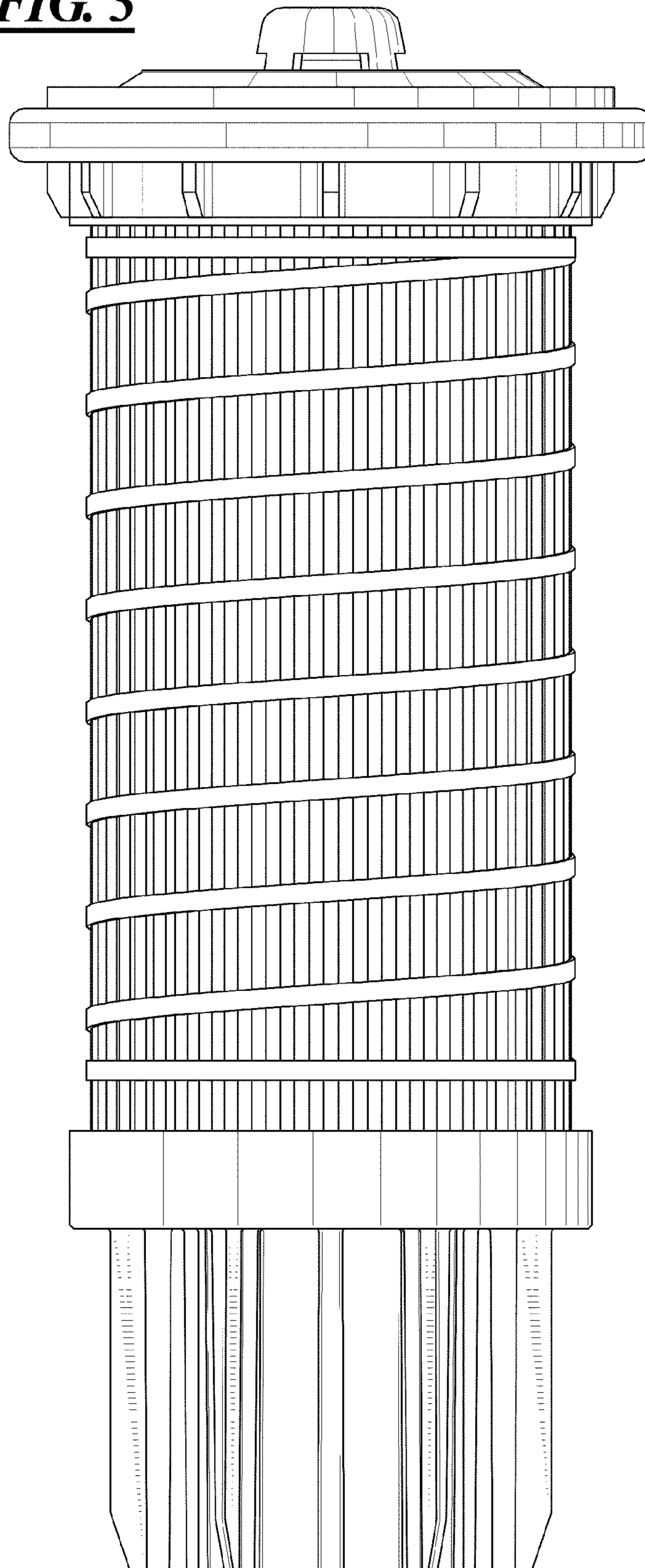

FIG. 4

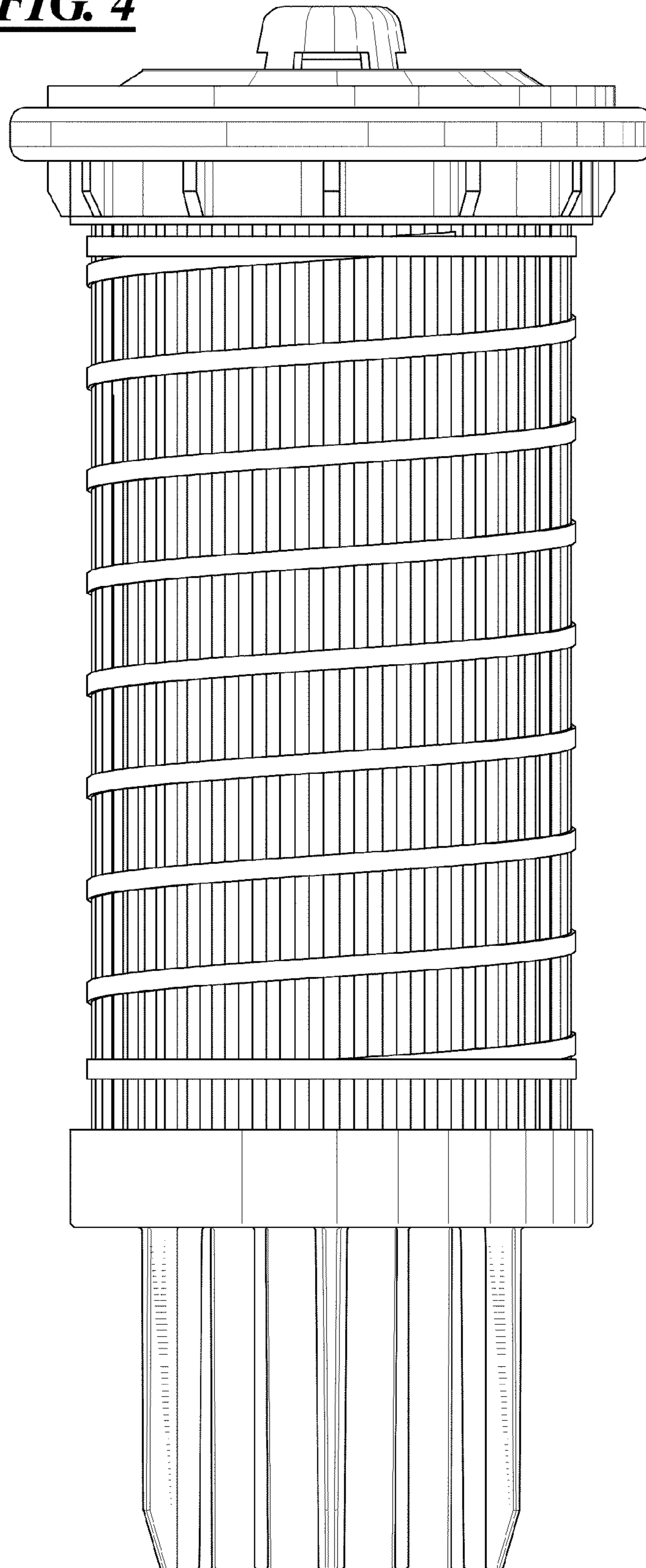

FIG. 5

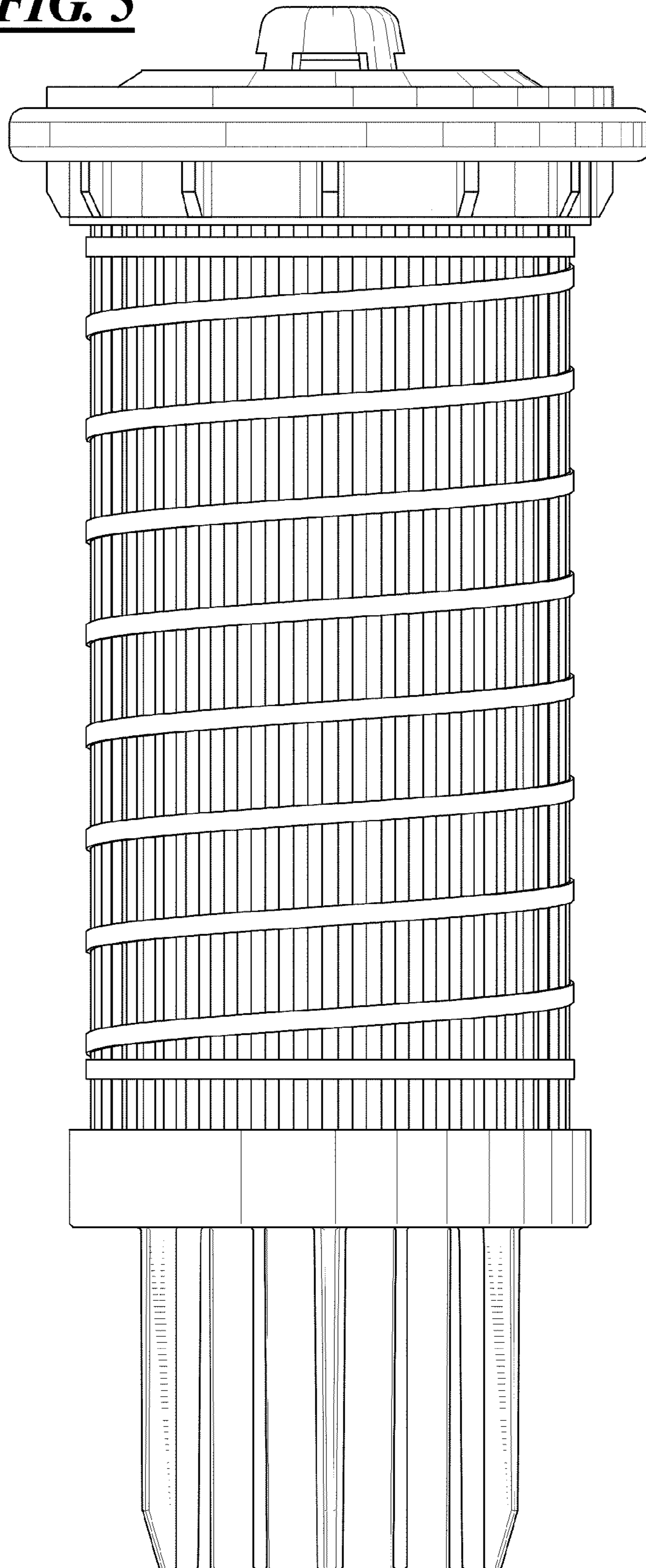

FIG. 6

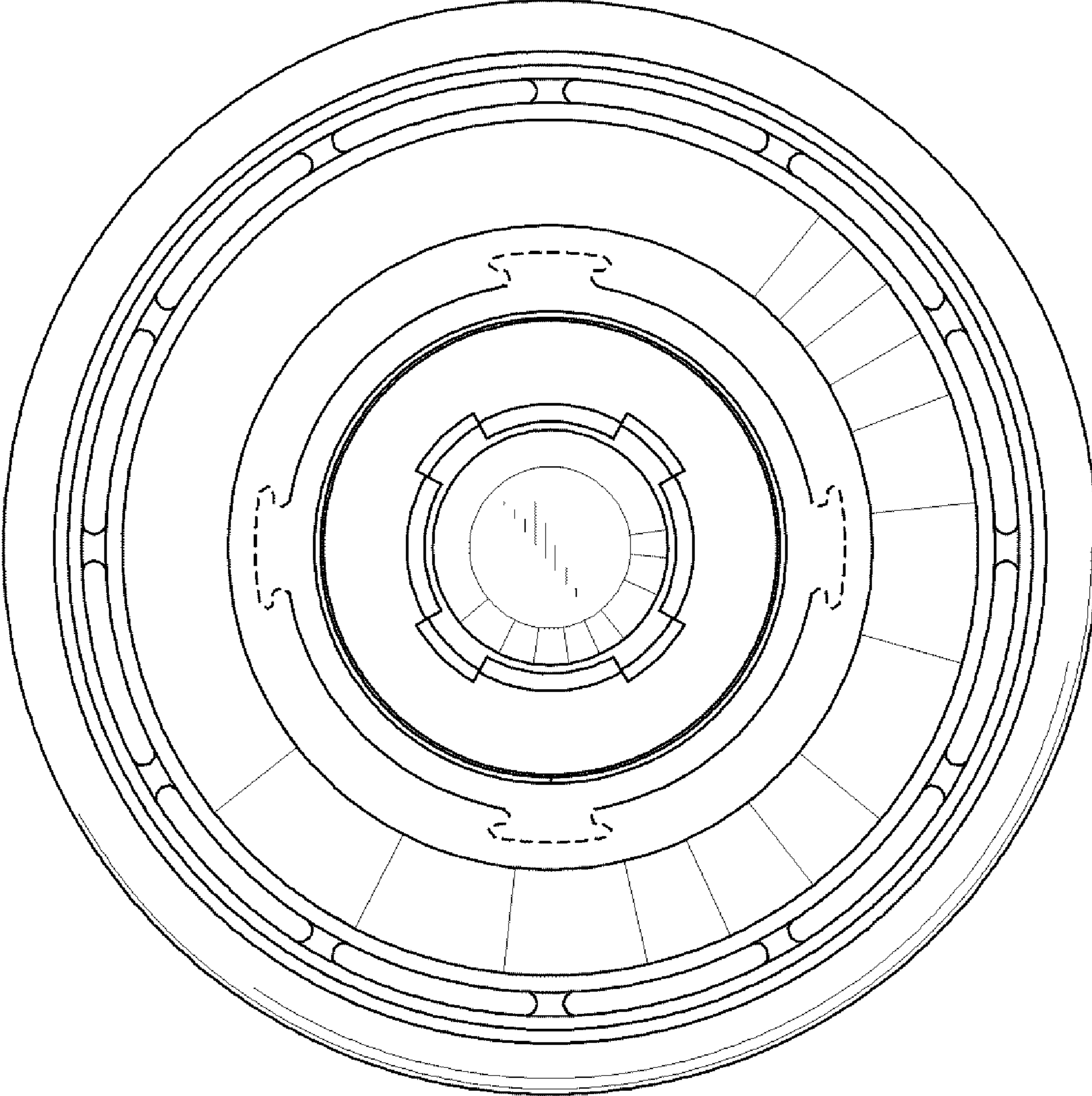

FIG. 7

