



US00D648637S

(12) **United States Design Patent**
Kauffmann

(10) **Patent No.:** **US D648,637 S**

(45) **Date of Patent:** **** Nov. 15, 2011**

(54) **WATCHCASE**

(75) **Inventor:** **Vincent Kauffmann**, Grand-Lancy (CH)

(73) **Assignee:** **Richemont International SA**,
Villars-sur-Glane (CH)

(**) **Term:** **14 Years**

(21) **Appl. No.:** **29/392,495**

(22) **Filed:** **May 23, 2011**

(30) **Foreign Application Priority Data**

Nov. 30, 2010 (WO) PCT/DM/074,956

(51) **LOC (9) Cl.** **10-02**

(52) **U.S. Cl.** **D10/38**

(58) **Field of Classification Search** D10/30-39;
368/276, 281, 282, 285

See application file for complete search history.

(56) **References Cited**

U.S. PATENT DOCUMENTS

D248,224 S *	6/1978	Sulek	D10/38
D413,818 S *	9/1999	Baumann	D10/32
D440,886 S *	4/2001	Burgener	D10/32
D444,077 S *	6/2001	Blondin	D10/39
D461,726 S *	8/2002	Jamin	D10/32
D462,015 S *	8/2002	Blondin	D10/30
D475,935 S *	6/2003	Modolo	D10/39
D484,814 S *	1/2004	Sugiura	D10/32

D494,477 S *	8/2004	Lalo	D10/30
D524,175 S *	7/2006	Zanette	D10/38
D526,912 S *	8/2006	Calvani	D10/38
D531,063 S *	10/2006	Reginelli	D10/32
D544,377 S *	6/2007	Chodat	D10/38
D564,370 S *	3/2008	Bove et al.	D10/38
D565,970 S *	4/2008	Ratajski et al.	D10/39
D566,583 S *	4/2008	Holtzman	D10/39
D581,815 S *	12/2008	Gopp	D10/38
D582,295 S *	12/2008	Schoepfer	D10/38
D589,375 S *	3/2009	Tang	D10/32

* cited by examiner

Primary Examiner — Lucy Lieberman

(74) *Attorney, Agent, or Firm* — Kalow & Springut, LLP;
Scott D. Locke, Esq.

(57) **CLAIM**

The ornamental design for a watchcase, as shown and described.

DESCRIPTION

FIG. 1 is a front view of the watchcase.

FIG. 2 is a back view of the watchcase.

FIG. 3 is a right side view of the watchcase.

FIG. 4 is a left side view of the watchcase.

FIG. 5 is a bottom side view of the watchcase.

FIG. 6 is a top side view of the watchcase; and,

FIG. 7 is a perspective view of the watchcase.

1 Claim, 3 Drawing Sheets

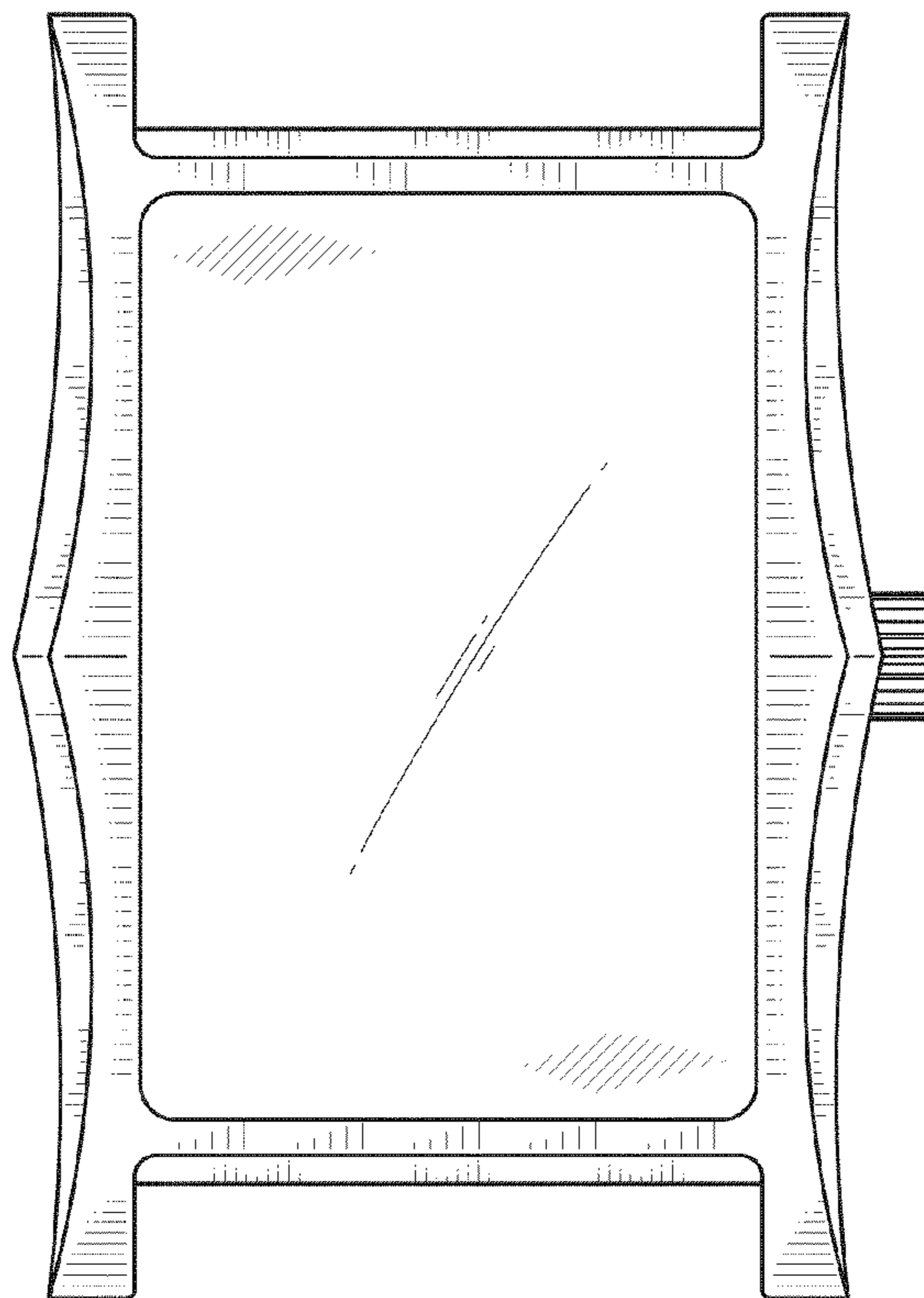

Fig. 1

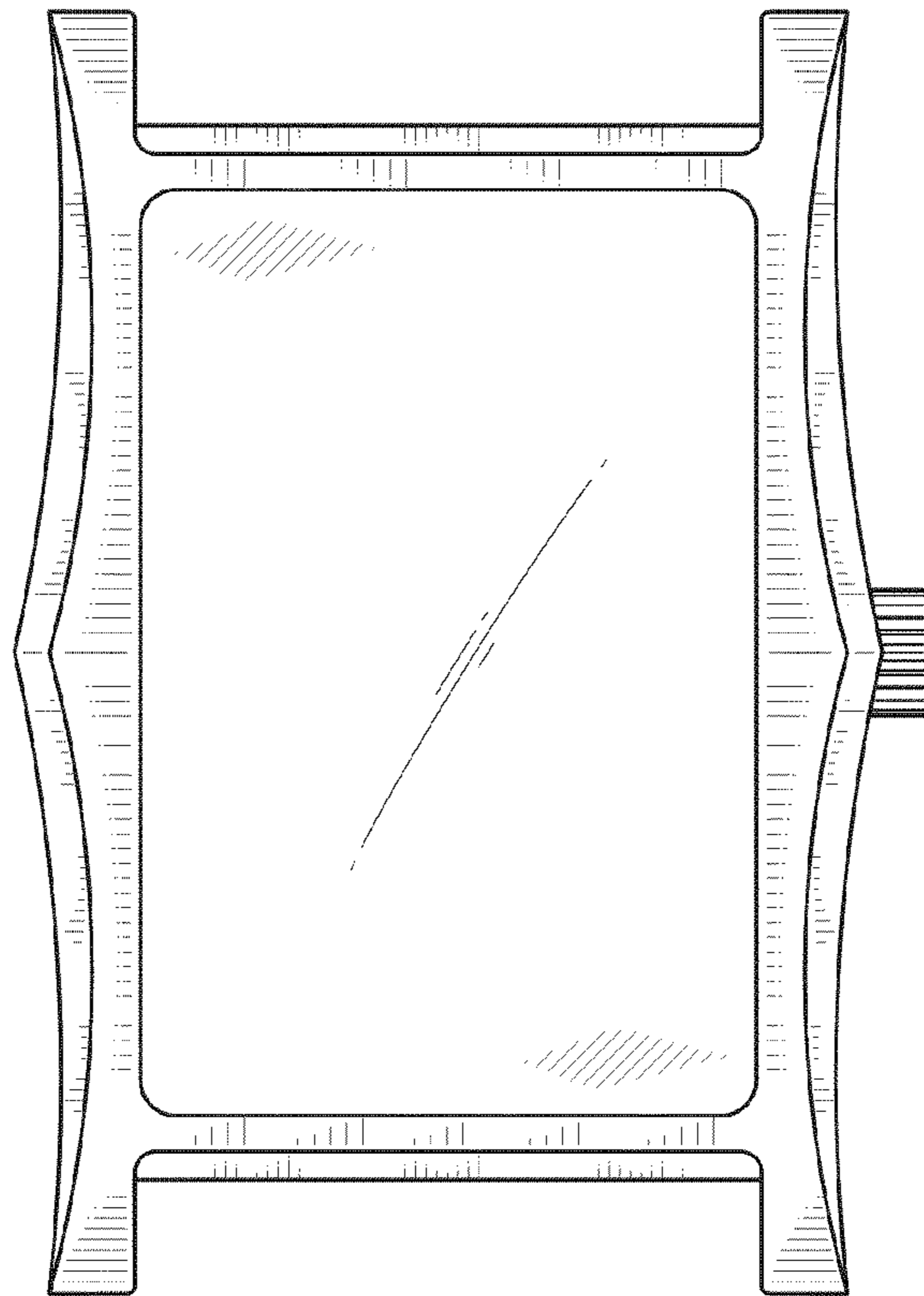

Fig. 2

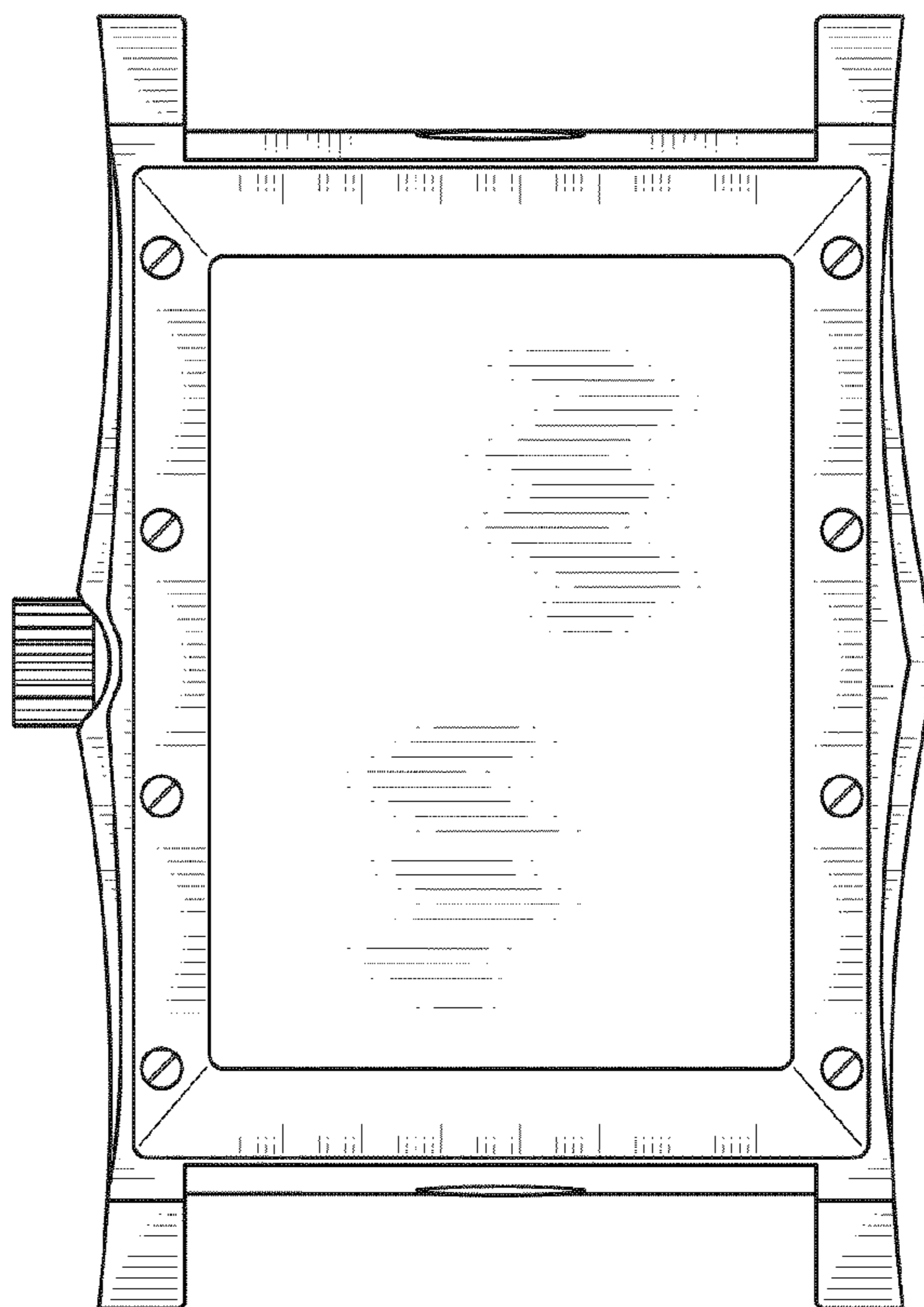

Fig. 3

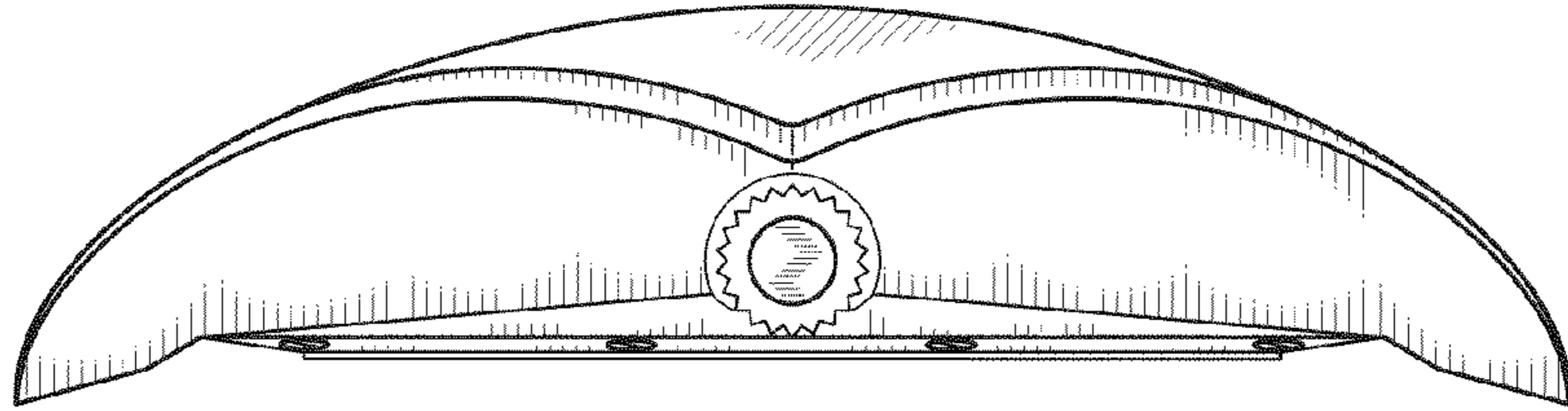

Fig. 4

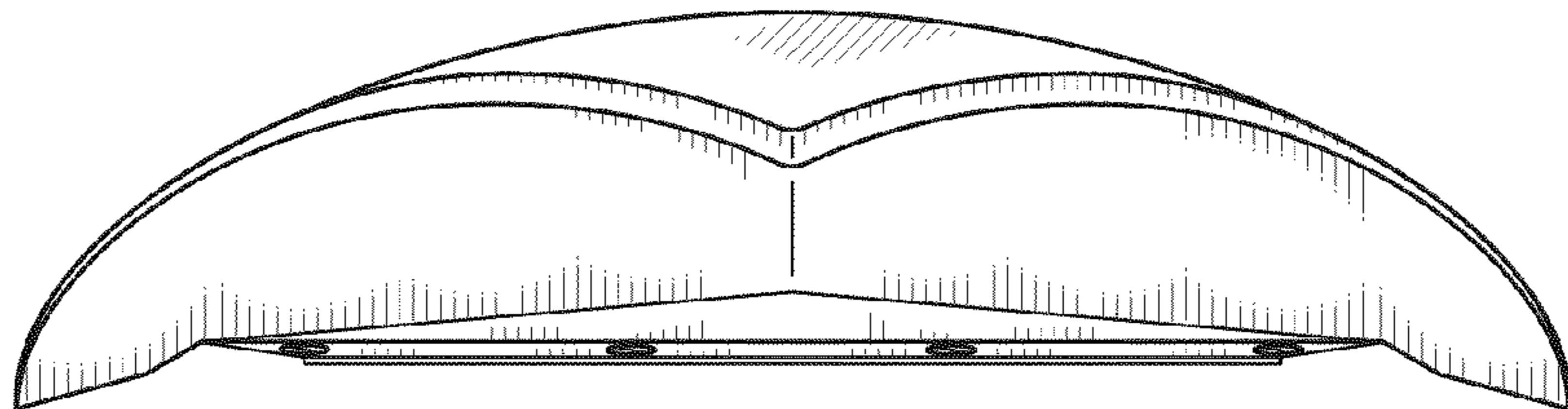

Fig. 5

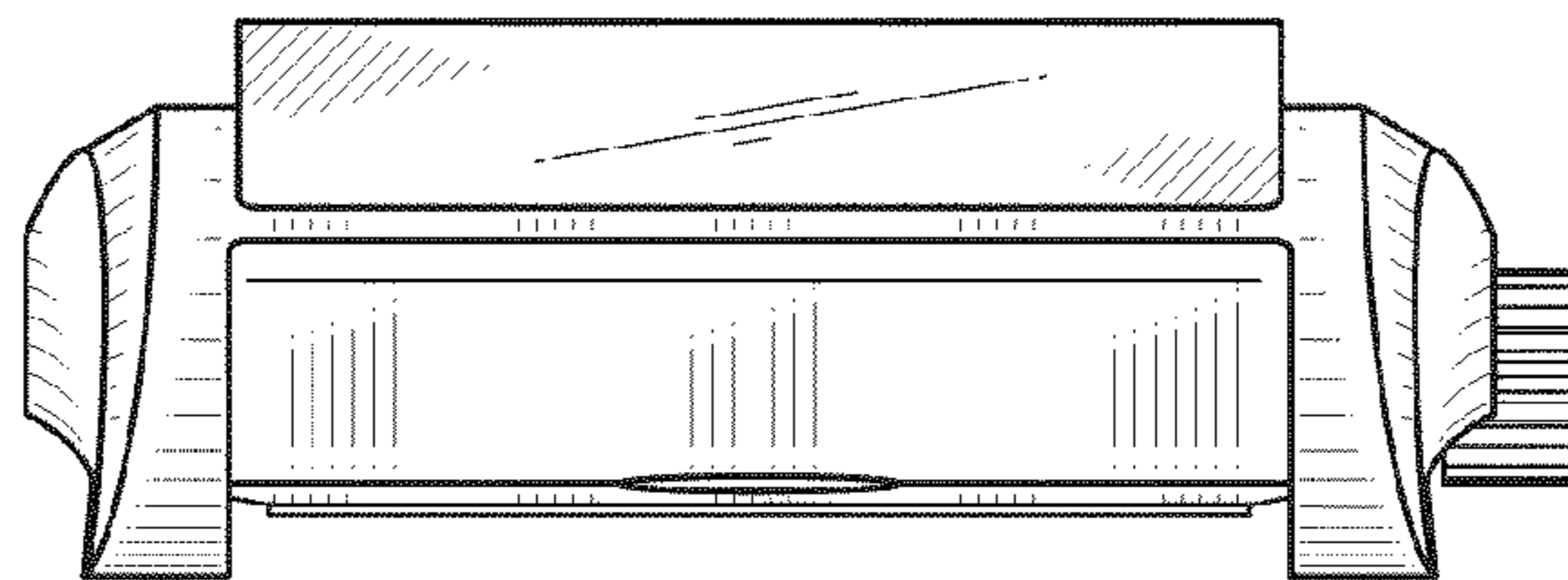

Fig. 6

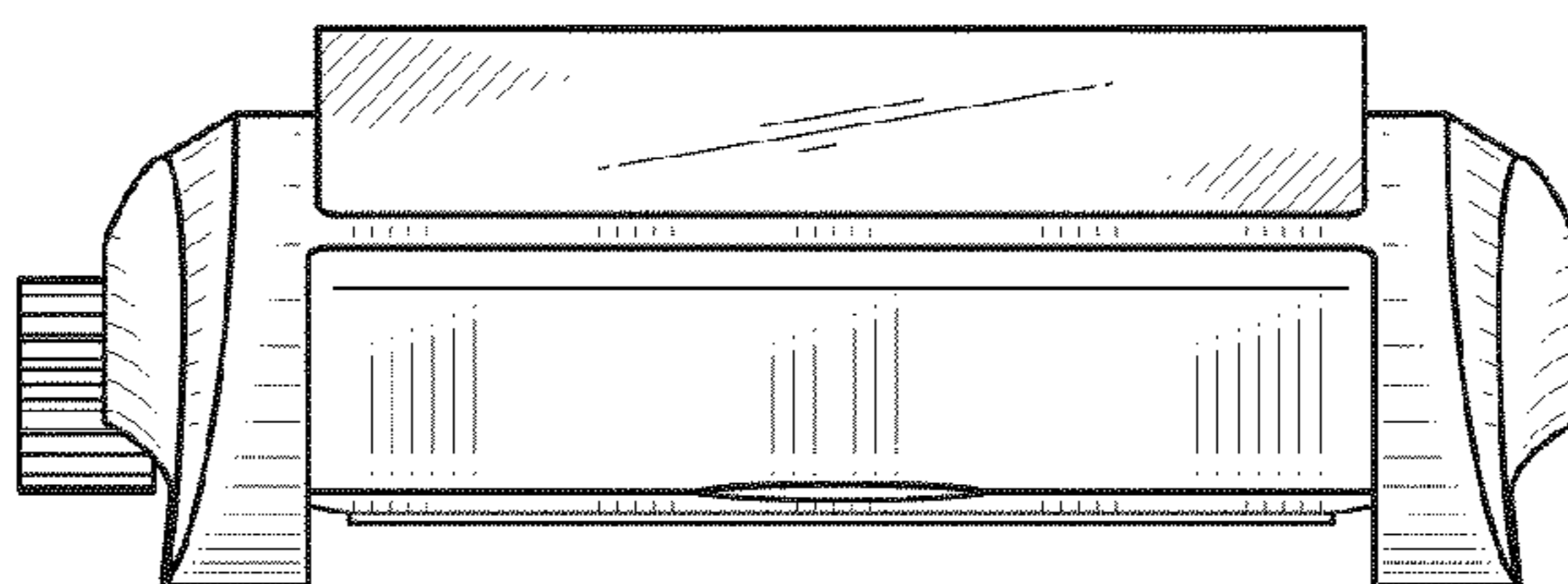

Fig. 7

