



US00D648608S

(12) **United States Design Patent**
Roberts et al.

(10) **Patent No.:** **US D648,608 S**
(45) **Date of Patent:** **** Nov. 15, 2011**

(54) **SCISSORS**

(75) Inventors: **Colin Roberts**, Stevens Point, WI (US);
Steven Stokes, Mazomanie, WI (US);
Theodore Jach, Cambridge, WI (US)

(73) Assignee: **Fiskars Brands, Inc.**, Madison, WI (US)

(**) Term: **14 Years**

(21) Appl. No.: **29/388,808**

(22) Filed: **Apr. 1, 2011**

(51) **LOC (9) Cl.** **08-05**

(52) **U.S. Cl.** **D8/51**

(58) **Field of Classification Search** D8/99,
D8/98, 93, 63, 61, 58, 57, 56, 55, 53, 5, 107,
D8/104, 105; D7/693; D24/148, 149; D21/532;
7/135; 606/45, 46, 48, 174; 30/349, 260,
30/123

See application file for complete search history.

(56) **References Cited**

U.S. PATENT DOCUMENTS

| | | | | |
|--------------|---------|----------------|-------|--------|
| D238,650 S * | 2/1976 | Koblick | | D8/5 |
| D299,108 S * | 12/1988 | Brdnik | | D8/107 |
| D309,409 S * | 7/1990 | Kiernan | | D8/4 |
| D322,546 S * | 12/1991 | Chan | | D8/57 |
| D340,854 S * | 11/1993 | Shimoharaguchi | | D8/98 |
| 5,297,343 A | 3/1994 | Melter et al. | | |
| D354,890 S | 1/1995 | Concari et al. | | |
| D359,214 S * | 6/1995 | Carlson et al. | | D8/51 |
| D359,427 S | 6/1995 | Birkholz | | |
| D361,700 S * | 8/1995 | Birkholz | | D8/5 |
| D369,531 S | 5/1996 | Birkholz | | |
| D377,588 S | 1/1997 | Birkholz | | |
| D426,433 S * | 6/2000 | Hurst | | D8/5 |

| | | | | |
|--------------|---------|-----------------|-------|---------|
| 6,643,936 B2 | 11/2003 | Carlson et al. | | |
| D555,442 S * | 11/2007 | Kaposi | | D8/5 |
| D570,167 S * | 6/2008 | Kaposi | | D8/5 |
| D576,011 S * | 9/2008 | Lipscomb et al. | | D8/107 |
| D576,468 S * | 9/2008 | Lipscomb et al. | | D8/107 |
| D600,092 S | 9/2009 | Peterson et al. | | |
| D630,080 S * | 1/2011 | Seeds et al. | | D8/105 |
| D641,221 S * | 7/2011 | Miyazaki | | D8/29.1 |

OTHER PUBLICATIONS

Fiskars Craft Products 2005 catalog, pp. 10-12 and 100.
U.S. Appl. No. 29/389,149, filed Apr. 7, 2011, Cunningham et al.

* cited by examiner

Primary Examiner — Austin Murphy

(74) *Attorney, Agent, or Firm* — Foley & Lardner LLP

(57) **CLAIM**

We claim the ornamental design for a set of scissors, as shown and described.

DESCRIPTION

FIG. 1 is a perspective view of a set of scissors showing our new design;

FIG. 2 is a right side elevational view thereof;

FIG. 3 is a left side elevational view thereof;

FIG. 4 is a front elevational view thereof;

FIG. 5 is a rear elevational view thereof;

FIG. 6 is a top plan view thereof;

FIG. 7 is a bottom plan view thereof; and,

FIG. 8 is a sectional view thereof taken along line 8-8 in FIG. 2, the sectional view being shown to depict contours on the exterior surface of the claimed design that may not be apparent from other views.

The broken lines shown are for illustrative purposes only and form no part of the claimed design.

1 Claim, 6 Drawing Sheets

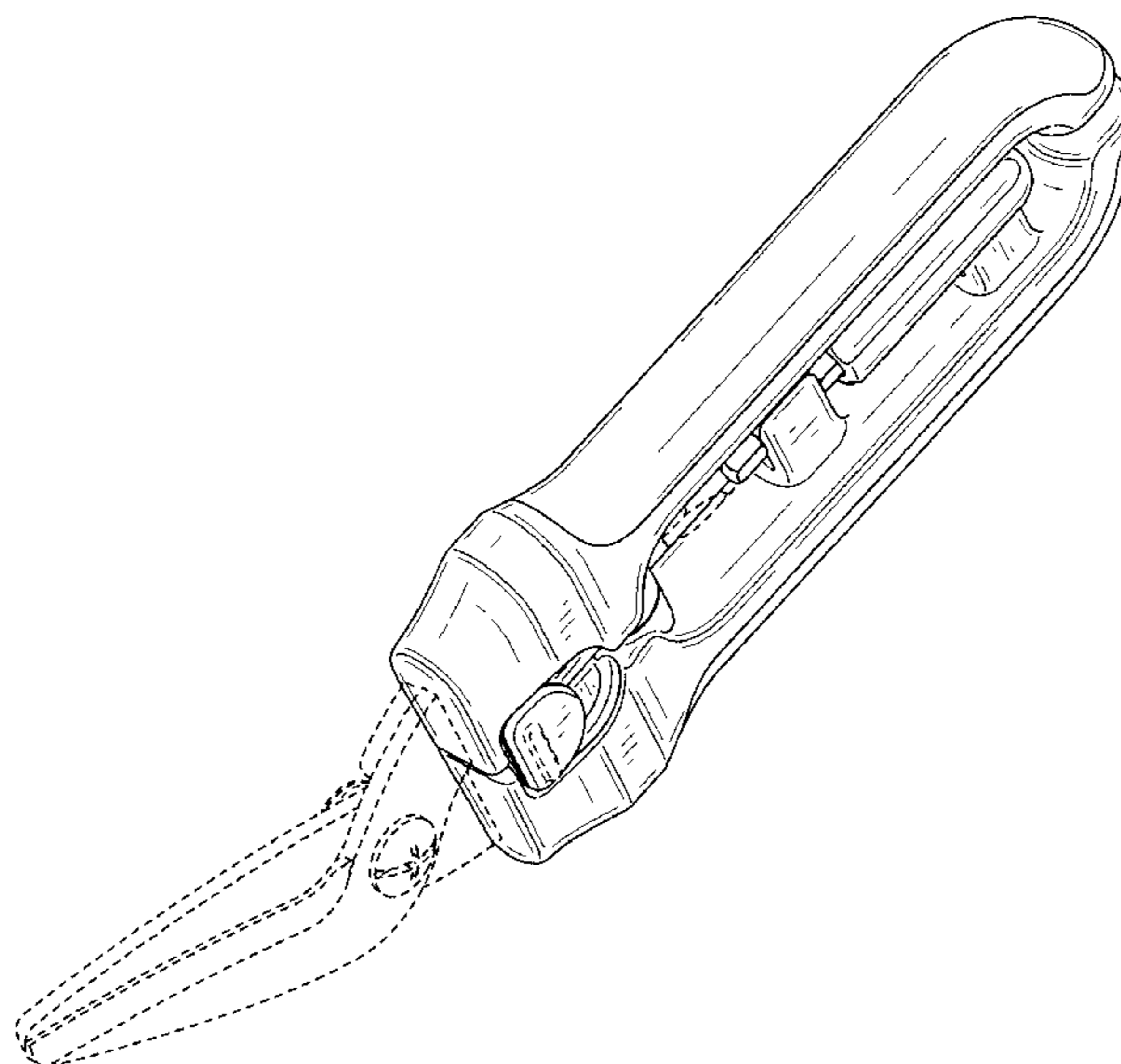

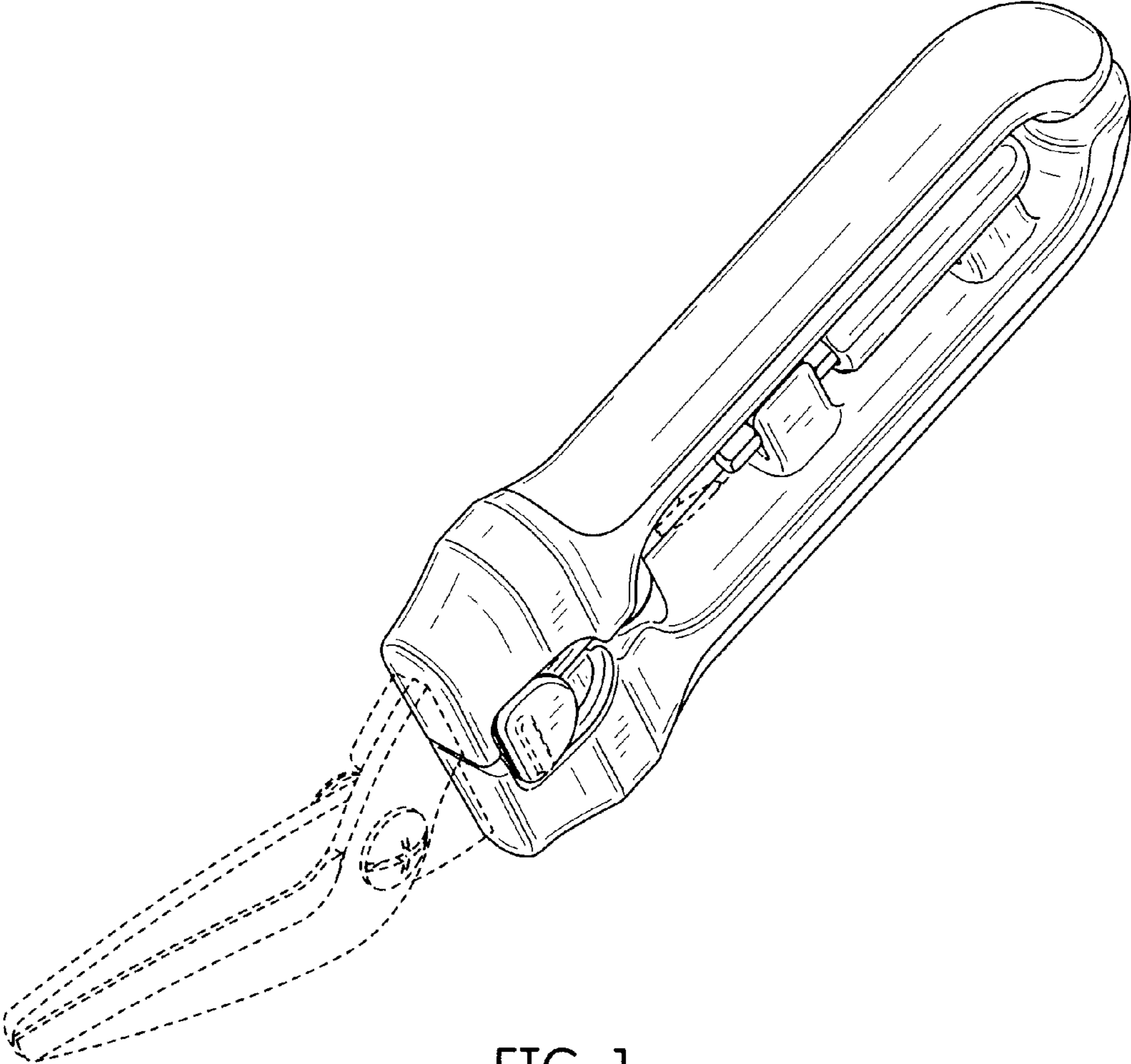

FIG. 1

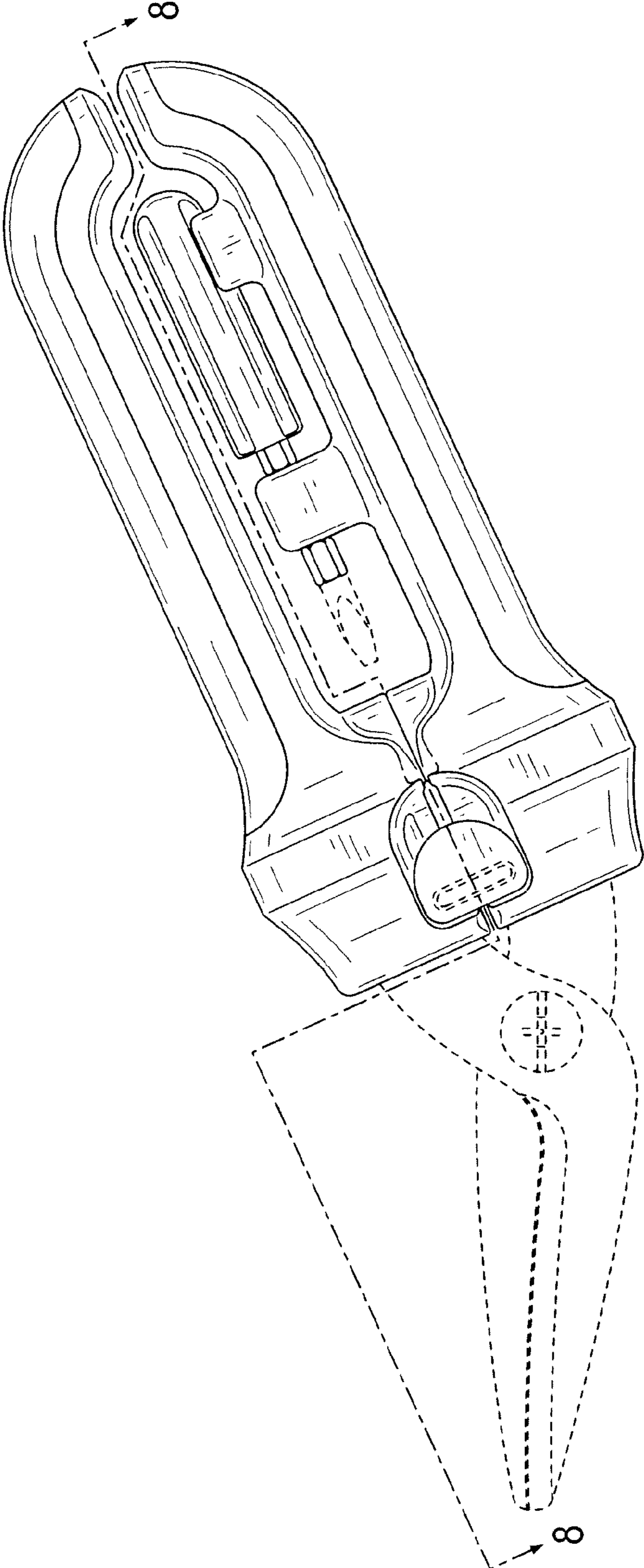

FIG. 2

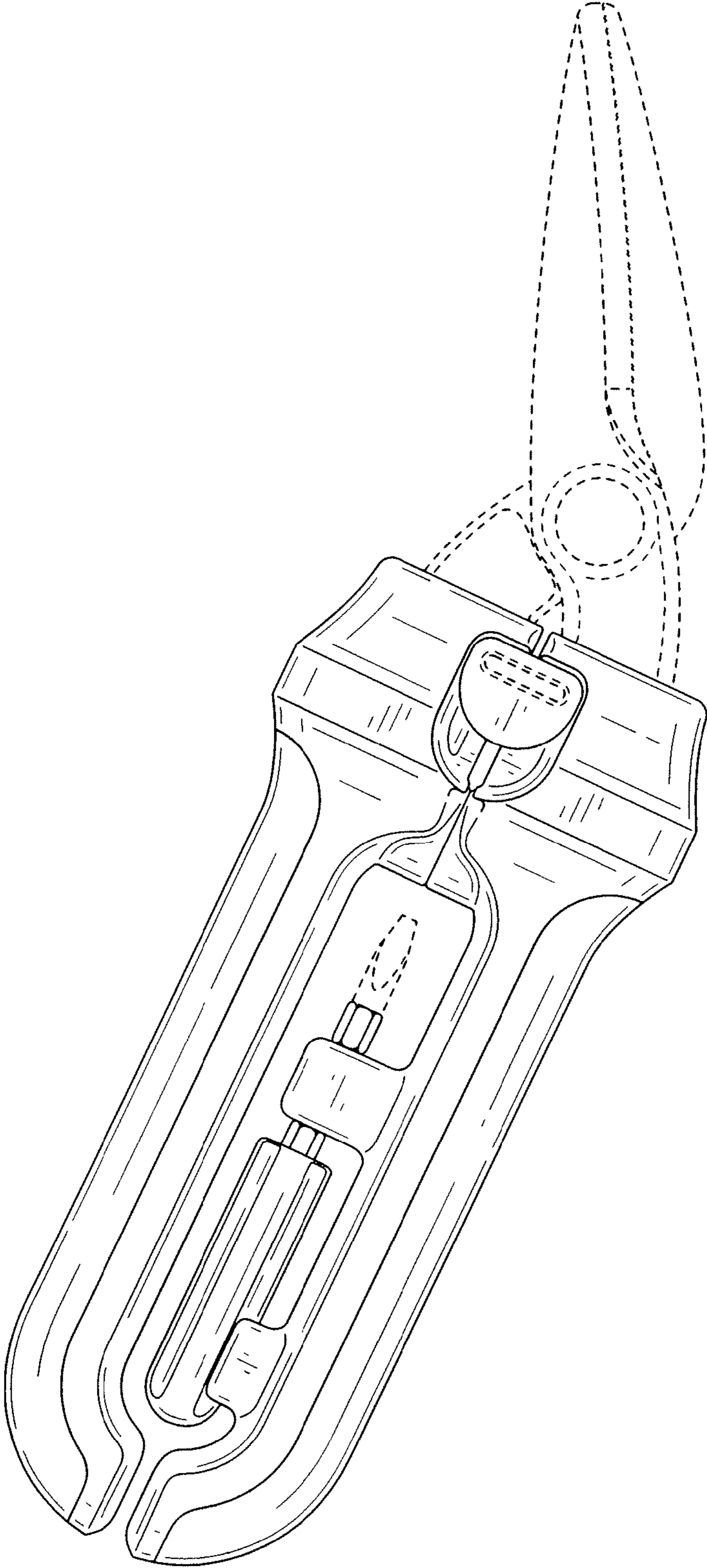

FIG. 3

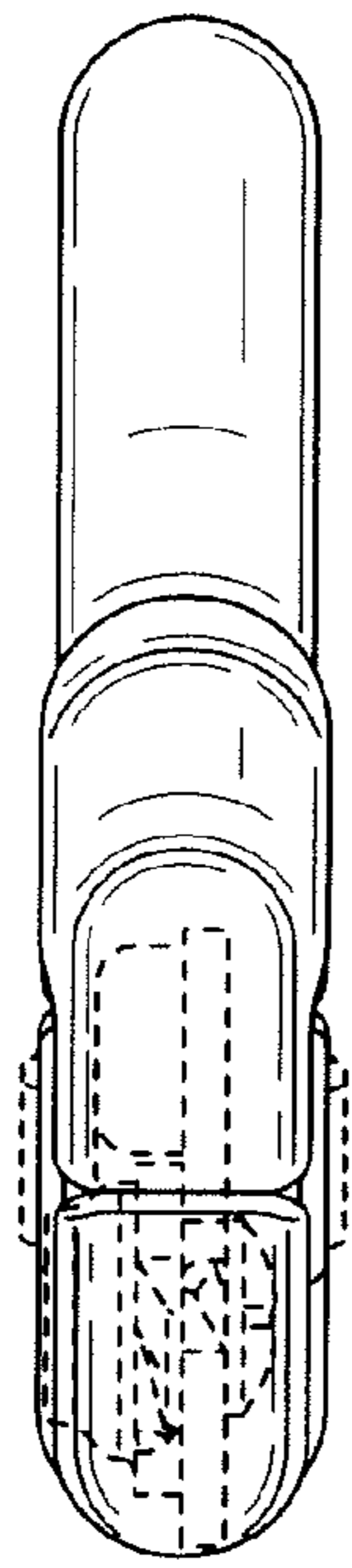

FIG. 4

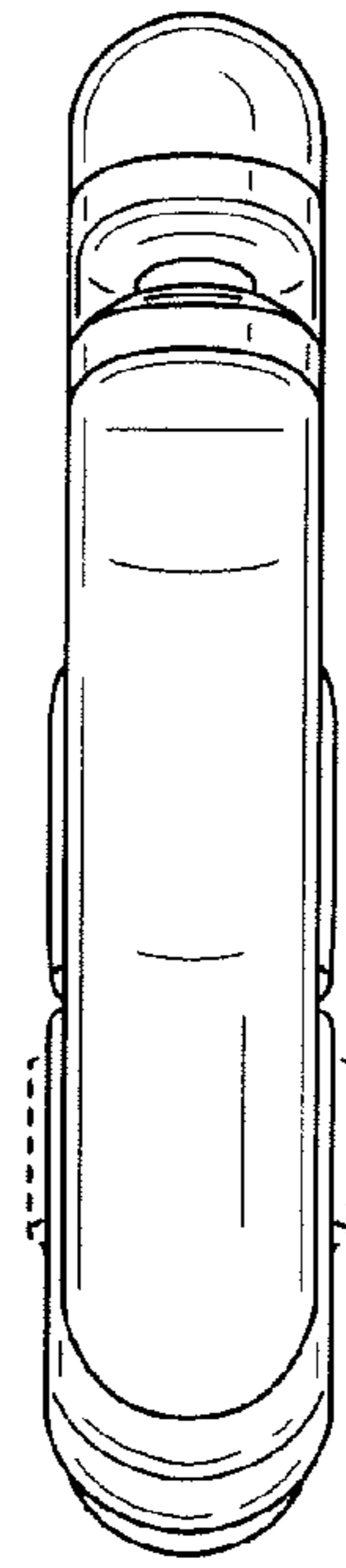

FIG. 5

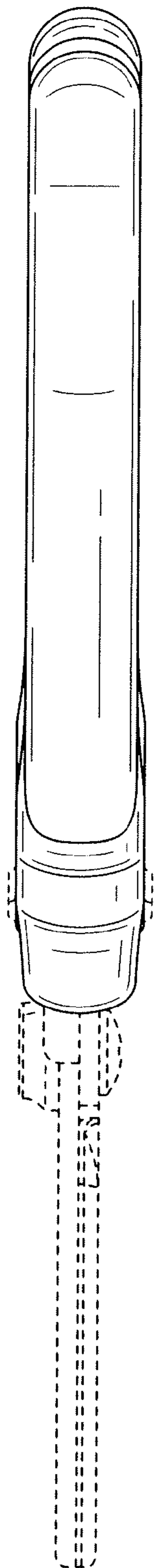

FIG. 6

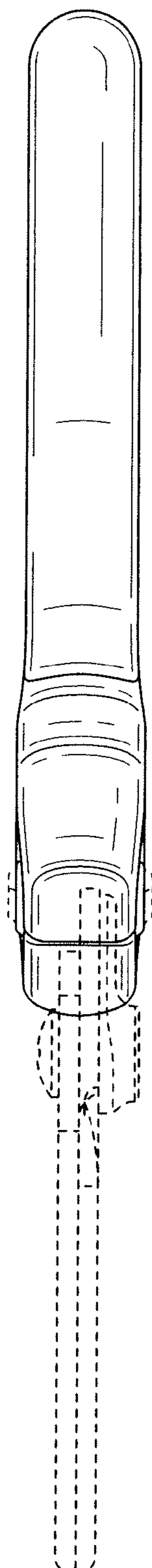

FIG. 7

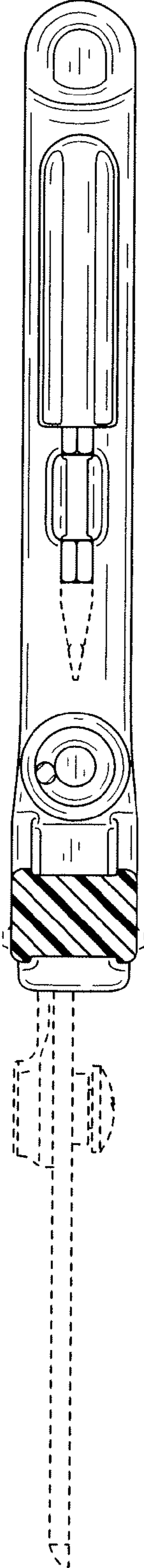

FIG. 8