



US00D648599S

(12) **United States Design Patent**  
**Watanabe et al.**

(10) **Patent No.:** **US D648,599 S**

(45) **Date of Patent:** **\*\* Nov. 15, 2011**

(54) **TUMBLER**

(75) Inventors: **Yoshiya Watanabe**, Tokyo (JP); **Toru Sakamoto**, Tokyo (JP)

(73) Assignees: **Thermos L.L.C.** IL (US); **Thermos K.K.** (JP)

(\*\*) Term: **14 Years**

(21) Appl. No.: **29/390,628**

(22) Filed: **Apr. 27, 2011**

(30) **Foreign Application Priority Data**

Dec. 14, 2010 (JP) ..... 2010-029740

(51) **LOC (9) Cl.** ..... **07-01**

(52) **U.S. Cl.** ..... **D7/523; D7/509**

(58) **Field of Classification Search** ..... D7/510,  
D7/511, 500, 532, 900, 523, 509; 215/121,  
215/382, 388, 387; 220/674, 715, 713, 718,  
220/592.16, 592.17, 709, 708; D9/551, 529

See application file for complete search history.

(56) **References Cited**

**U.S. PATENT DOCUMENTS**

D47,800 S \* 9/1915 Pick ..... D7/523  
D67,869 S \* 7/1925 Boswell ..... D7/523

1,771,186 A \* 7/1930 Mock ..... 62/457.3  
5,076,463 A \* 12/1991 McGraw ..... 220/592.17  
D454,278 S \* 3/2002 Kerman ..... D7/509  
D457,389 S \* 5/2002 Snell ..... D7/396.6  
D466,371 S \* 12/2002 Parker ..... D7/510  
D472,101 S \* 3/2003 Janky ..... D7/532  
D488,673 S \* 4/2004 Farce ..... D7/523  
D490,274 S \* 5/2004 Irvine ..... D7/603  
2006/0213912 A1 \* 9/2006 Zaytoun ..... 220/293

\* cited by examiner

*Primary Examiner* — Cynthia Underwood

(74) *Attorney, Agent, or Firm* — Ackerman Senterfitt

(57) **CLAIM**

The ornamental design for a tumbler, as shown and described.

**DESCRIPTION**

FIG. 1 is a front perspective view from above of a tumbler, showing our new design:

FIG. 2 is a front view thereof, the rear and side views being identical;

FIG. 3 is a top plan view thereof;

FIG. 4 is a bottom plan view thereof;

FIG. 5 is a cross-sectional view thereof, taken along line 5-5 of FIG. 2; and,

FIG. 6 is an enlarged, fragmentary view thereof, taken along line 6-6 of FIG. 2.

**1 Claim, 5 Drawing Sheets**

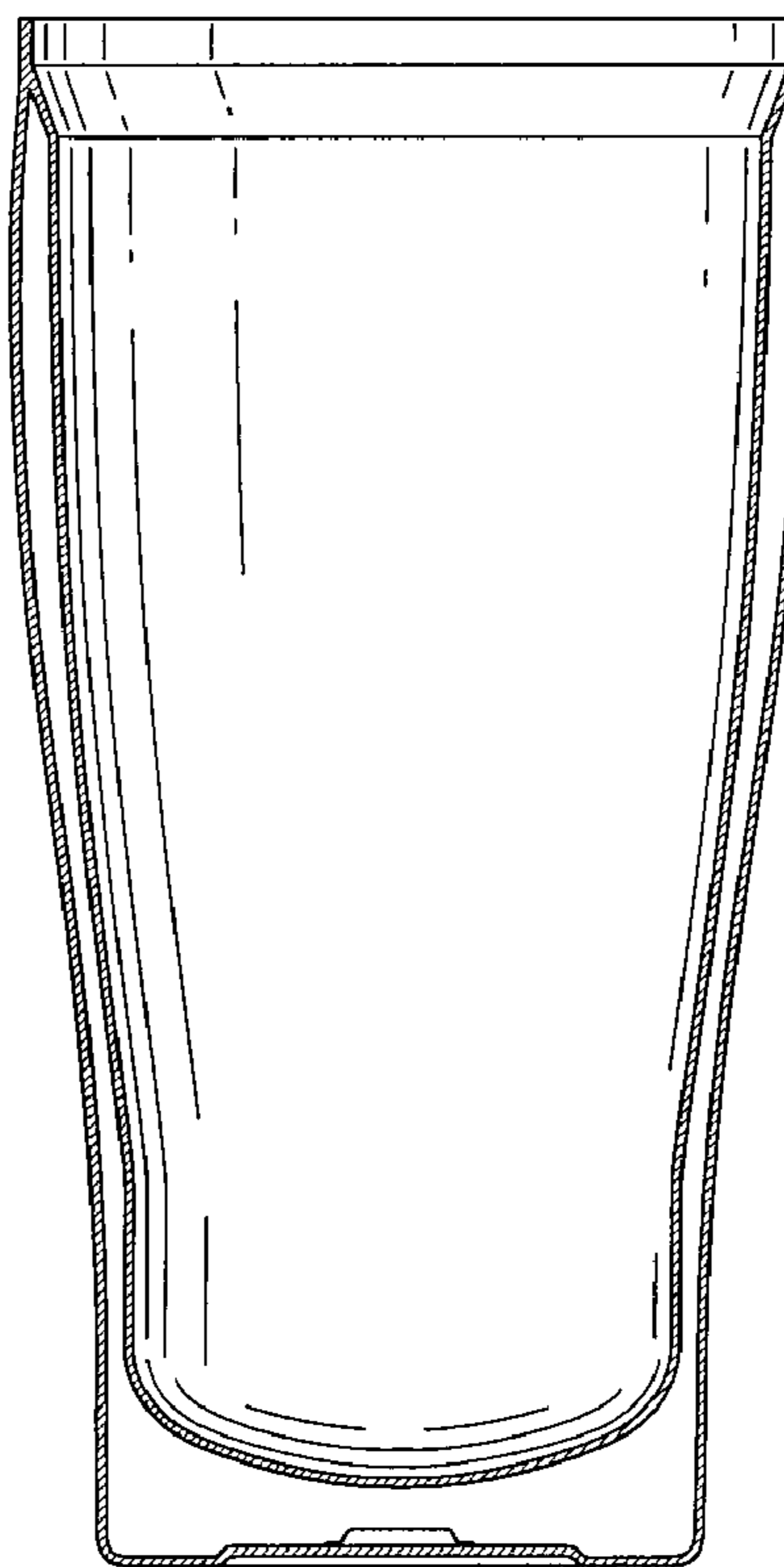
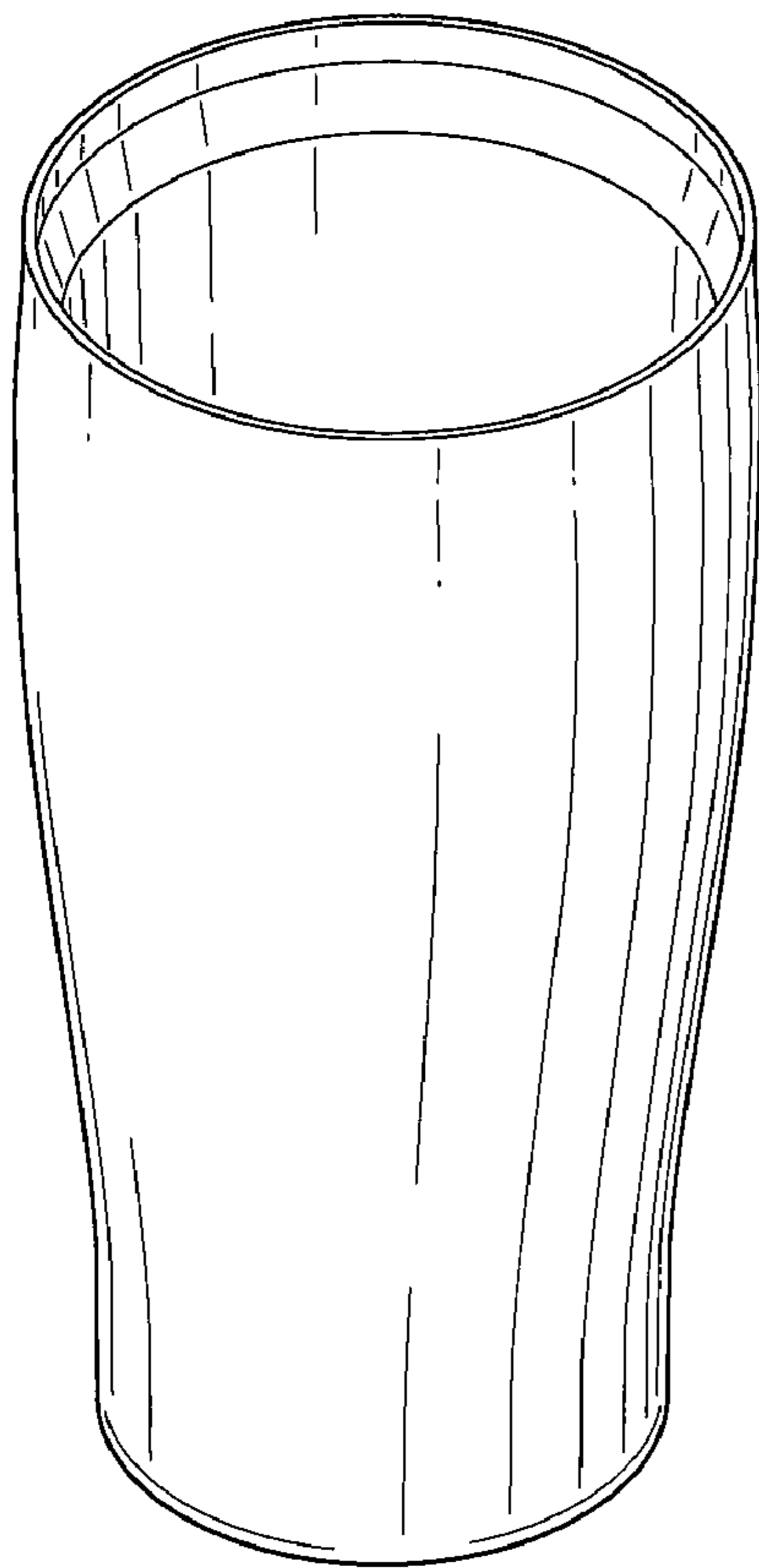

FIG. 1

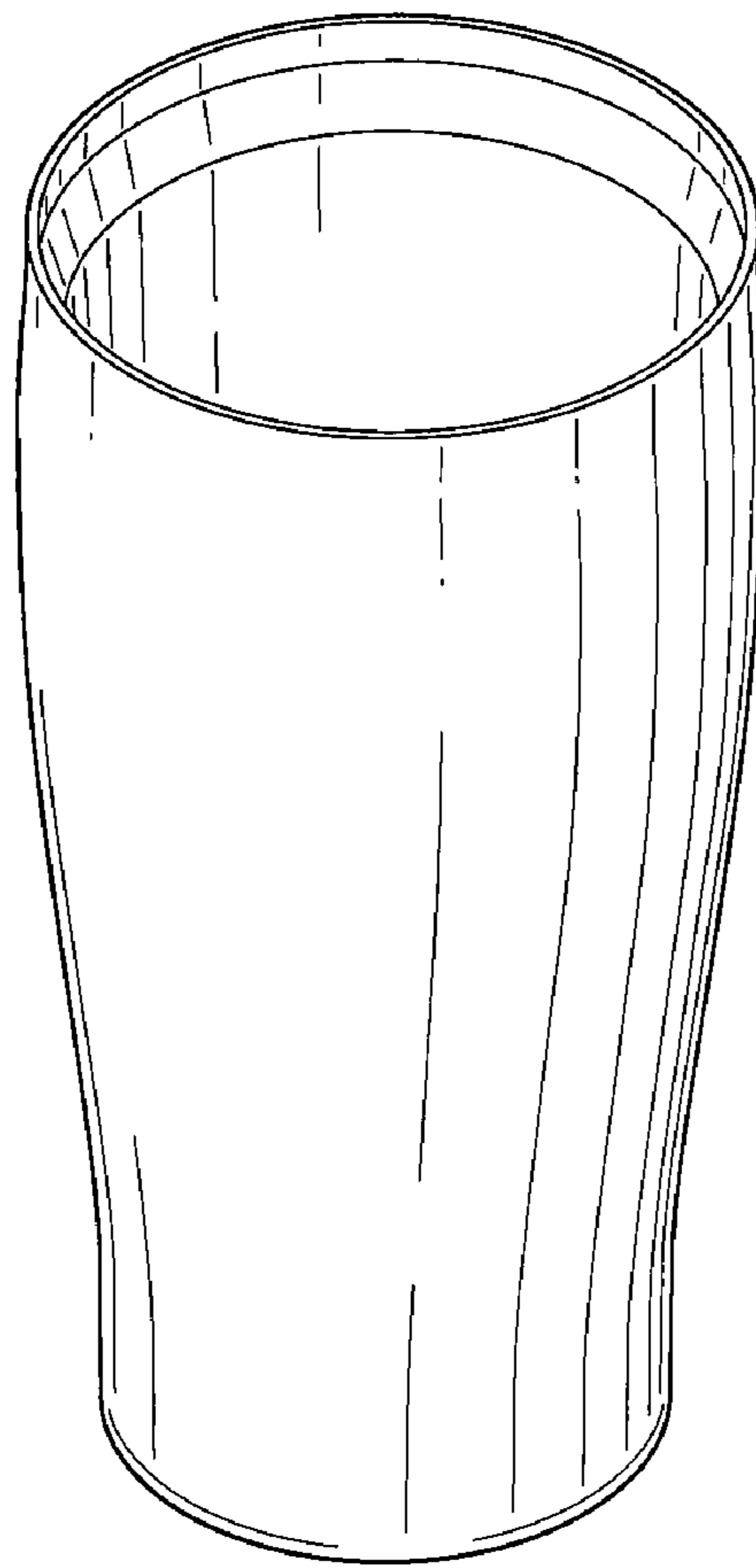

FIG.2

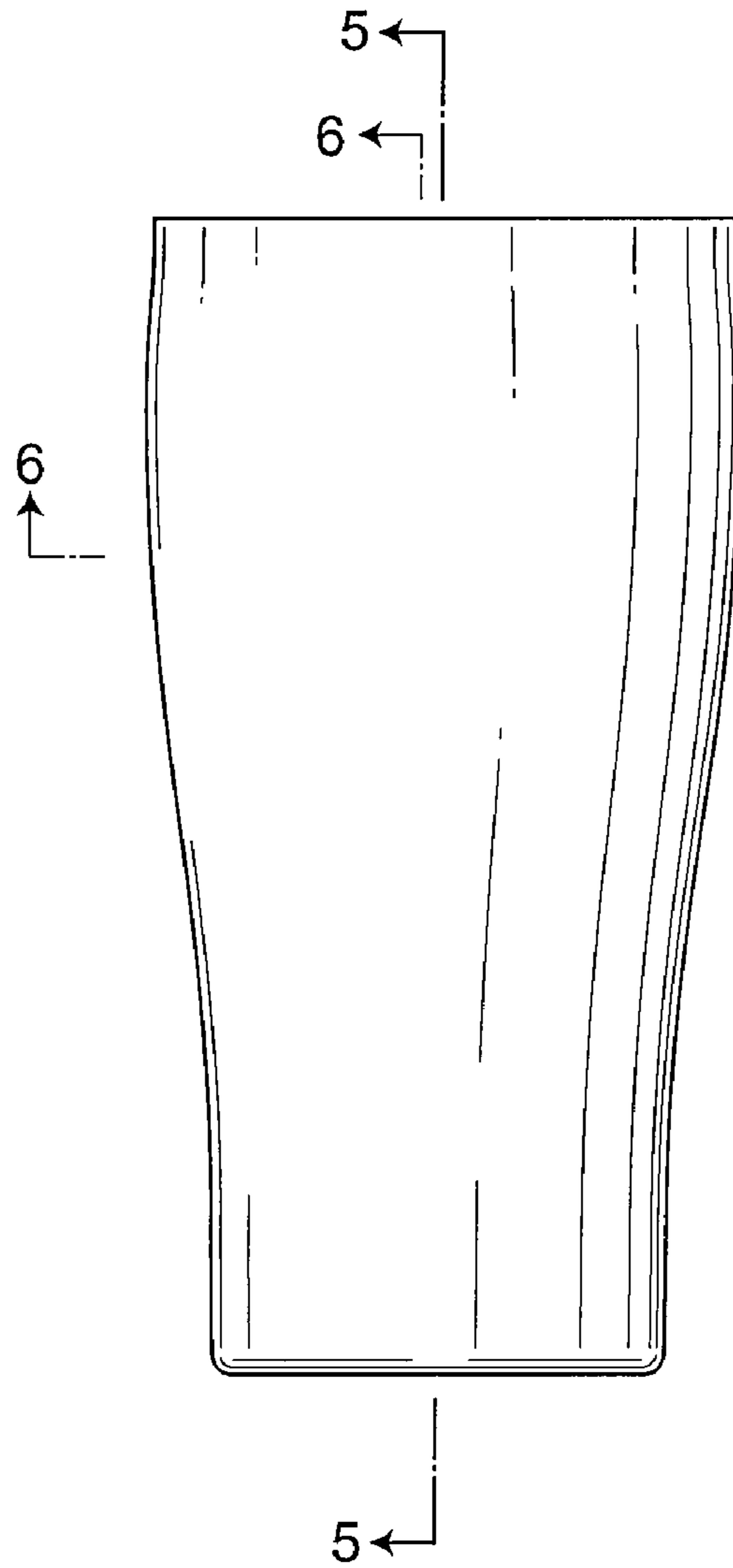

FIG.3

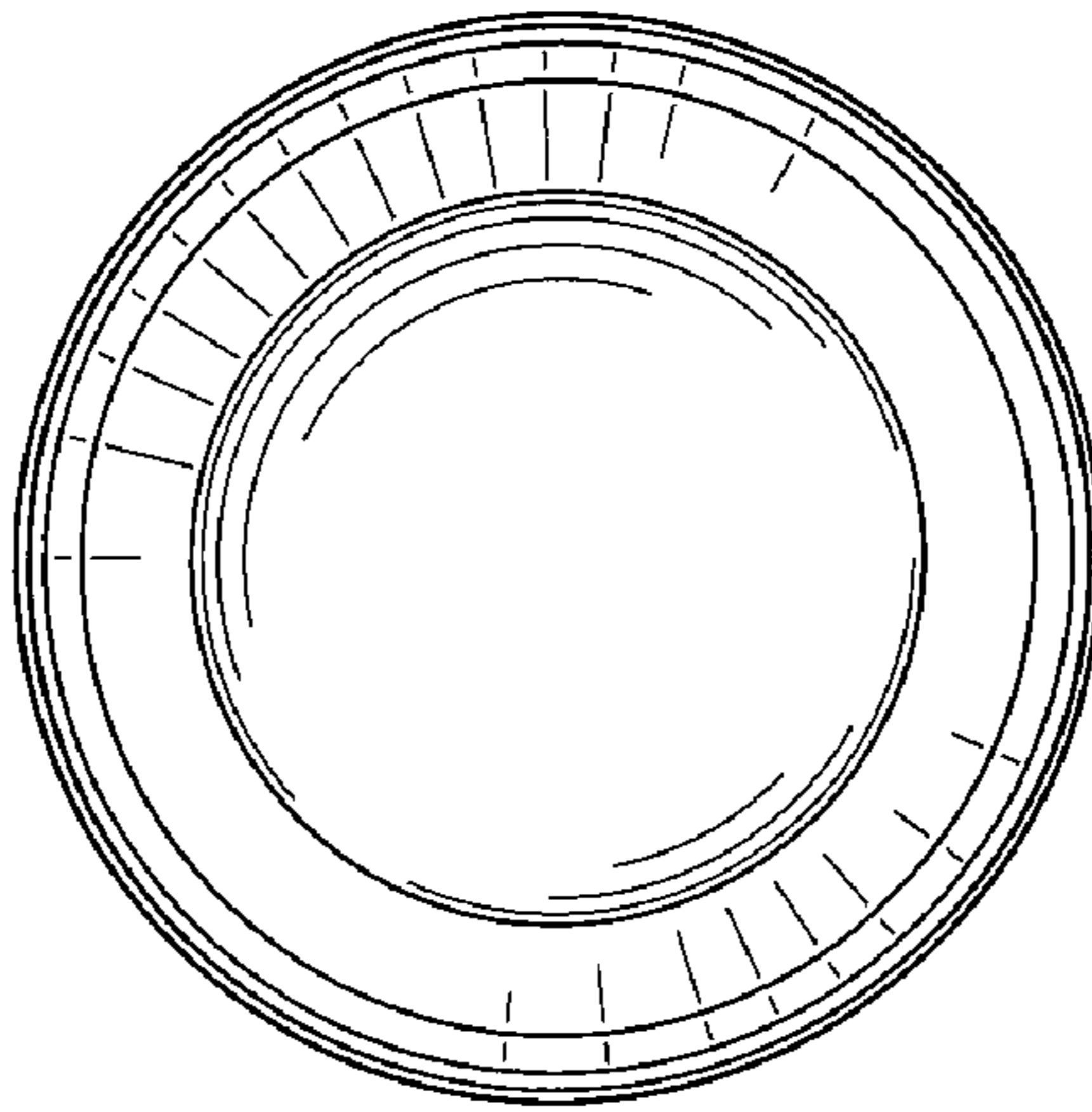

FIG.4

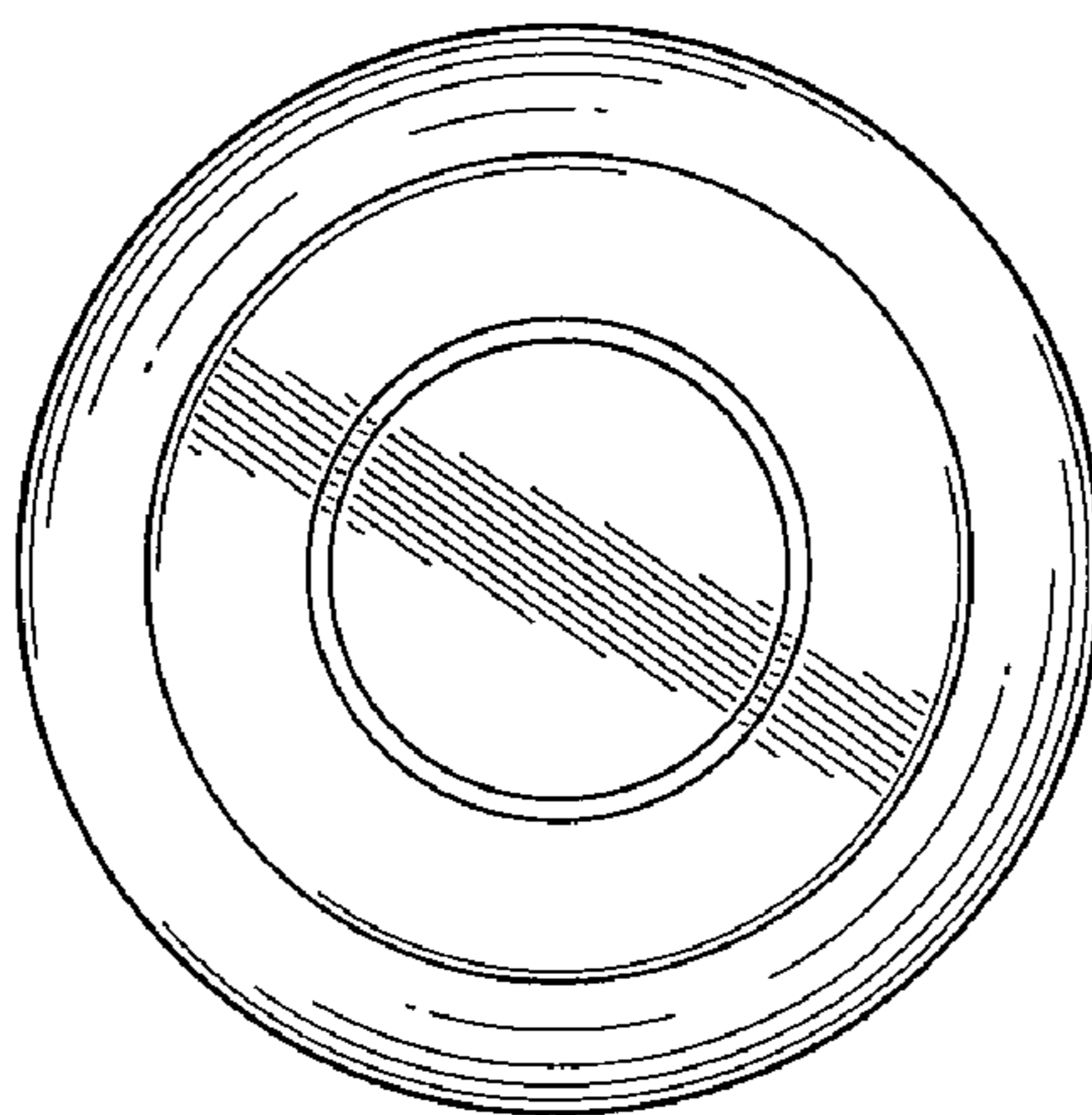

FIG.5

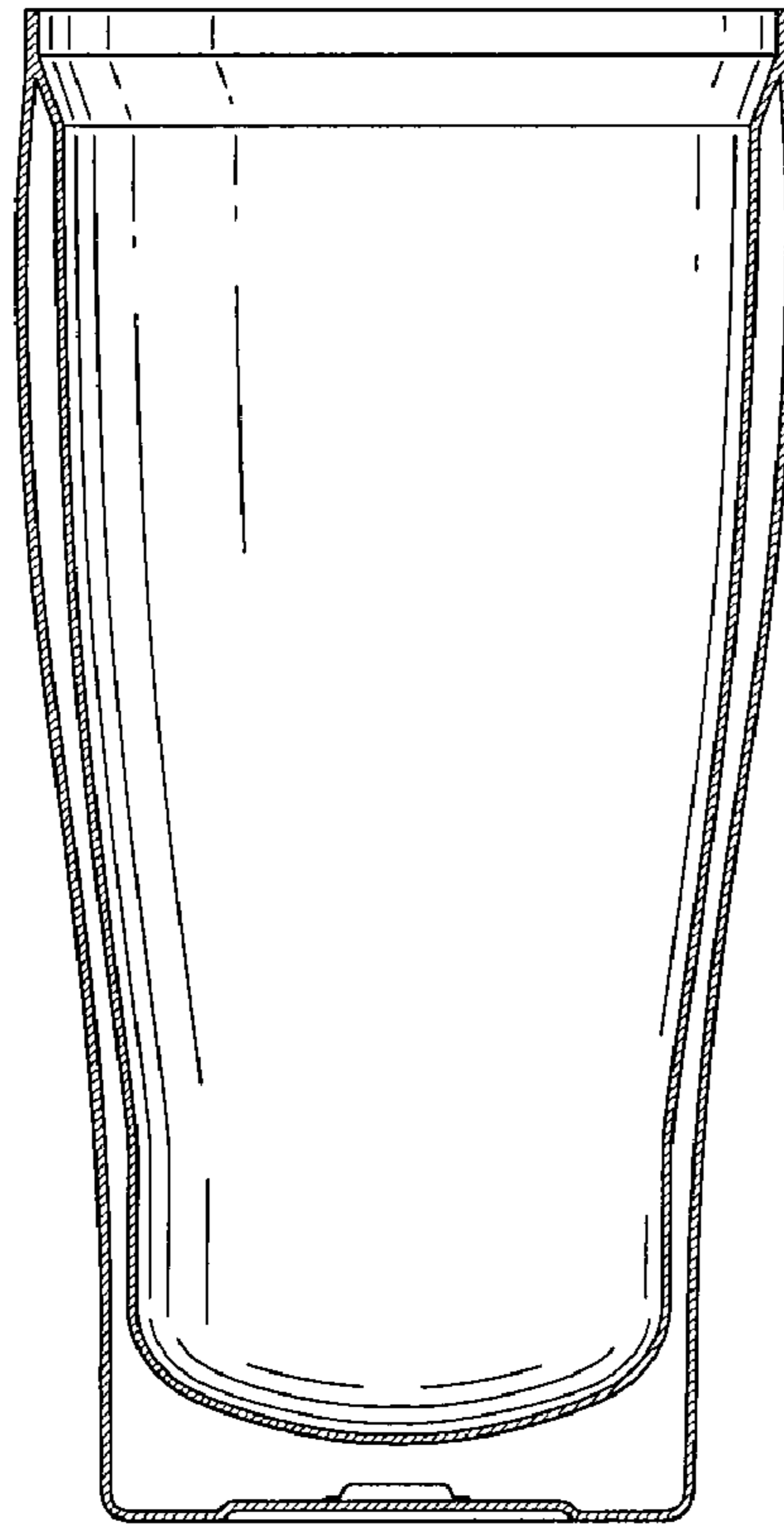

FIG.6

