



US00D648443S

(12) **United States Design Patent**
Busschaert et al.

(10) **Patent No.:** **US D648,443 S**

(45) **Date of Patent:** **** Nov. 8, 2011**

(54) **SAW HORSE COMBINATION**

6,789,649 B2 * 9/2004 Herrmann 182/186.7
D552,256 S * 10/2007 Thurston D25/68
D589,780 S * 4/2009 Fernandez D8/330

(75) Inventors: **Jason F. Busschaert**, Bel Air, MD (US);
James A. Downing, Owings Mills, MD
(US); **Torrey R. Lambert**, Baltimore,
MD (US)

* cited by examiner

Primary Examiner — Doris Clark

(74) *Attorney, Agent, or Firm* — Adan Ayala

(73) Assignee: **Black & Decker Inc.**, Newark, DE (US)

(**) Term: **14 Years**

(57) **CLAIM**

We claim the ornamental design for a portion of a sawhorse combination, as shown and described.

(21) Appl. No.: **29/389,547**

(22) Filed: **Apr. 13, 2011**

DESCRIPTION

Related U.S. Application Data

(63) Continuation of application No. 29/378,544, filed on Nov. 5, 2010, now Pat. No. Des. 638,140.

(51) **LOC (9) Cl.** **25-04**

(52) **U.S. Cl.** **D25/68; D8/336**

(58) **Field of Classification Search** D25/67,
D25/68; 182/181.1, 186.5, 224, 153, 186.8,
182/186.7, 151; D8/336

See application file for complete search history.

FIG. 1 is a perspective view of portion of a saw horse combination according to the invention.

FIG. 2 is a right side view of the portion of the saw horse combination.

FIG. 3 is a left side view of the portion of the saw horse combination.

FIG. 4 is a front elevational view of the portion of the saw horse combination.

FIG. 5 is a top plan view of the portion of the saw horse combination; and,

FIG. 6 is a bottom plan view of the portion of the saw horse combination.

The broken lines are for illustrative purposes only and form no part of claimed design.

(56) **References Cited**

U.S. PATENT DOCUMENTS

2,959,245 A * 11/1960 O'Keefe 182/151
D328,355 S * 7/1992 Librach D25/67
6,401,865 B1 * 6/2002 Elwick 182/182.1

1 Claim, 5 Drawing Sheets

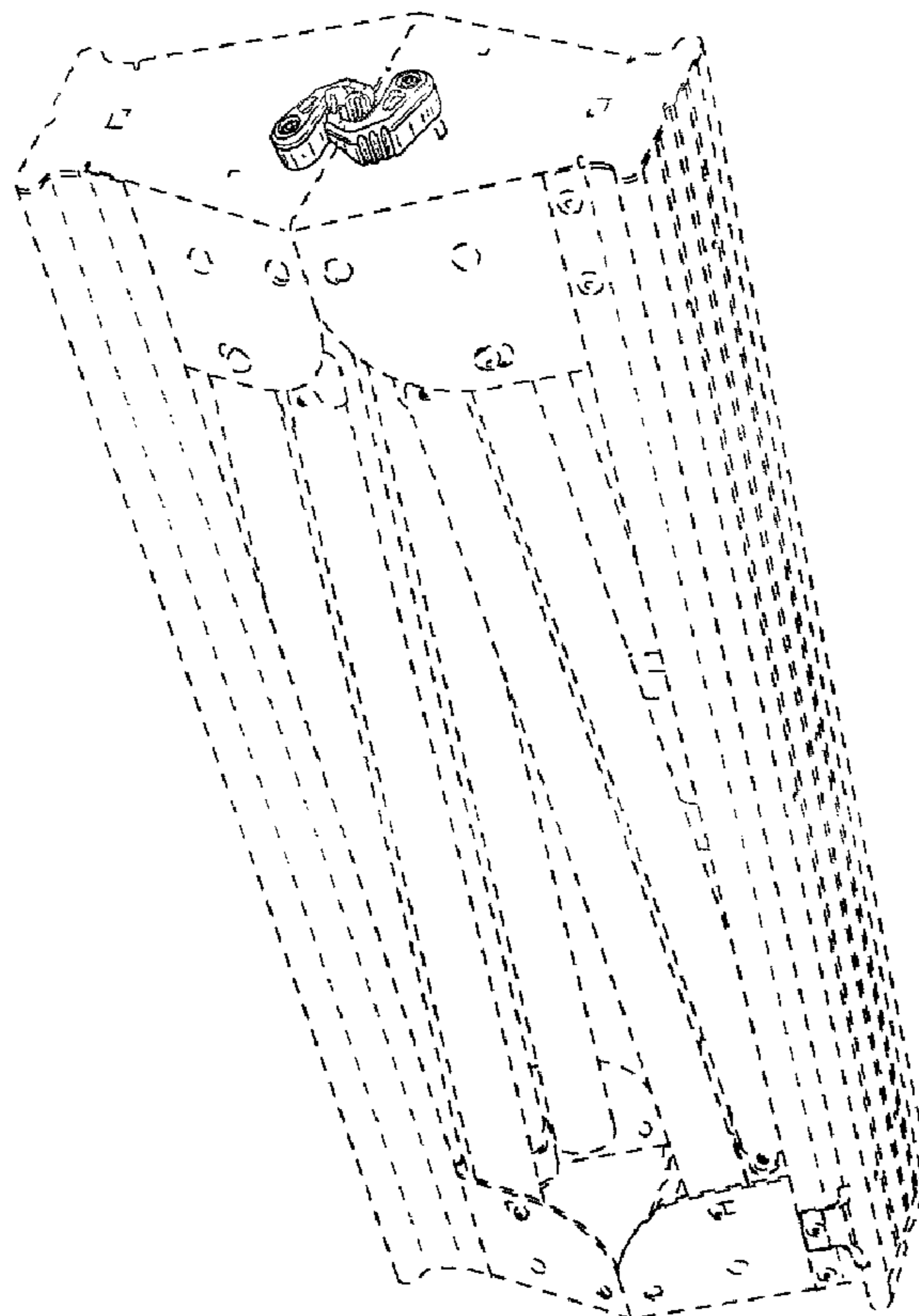

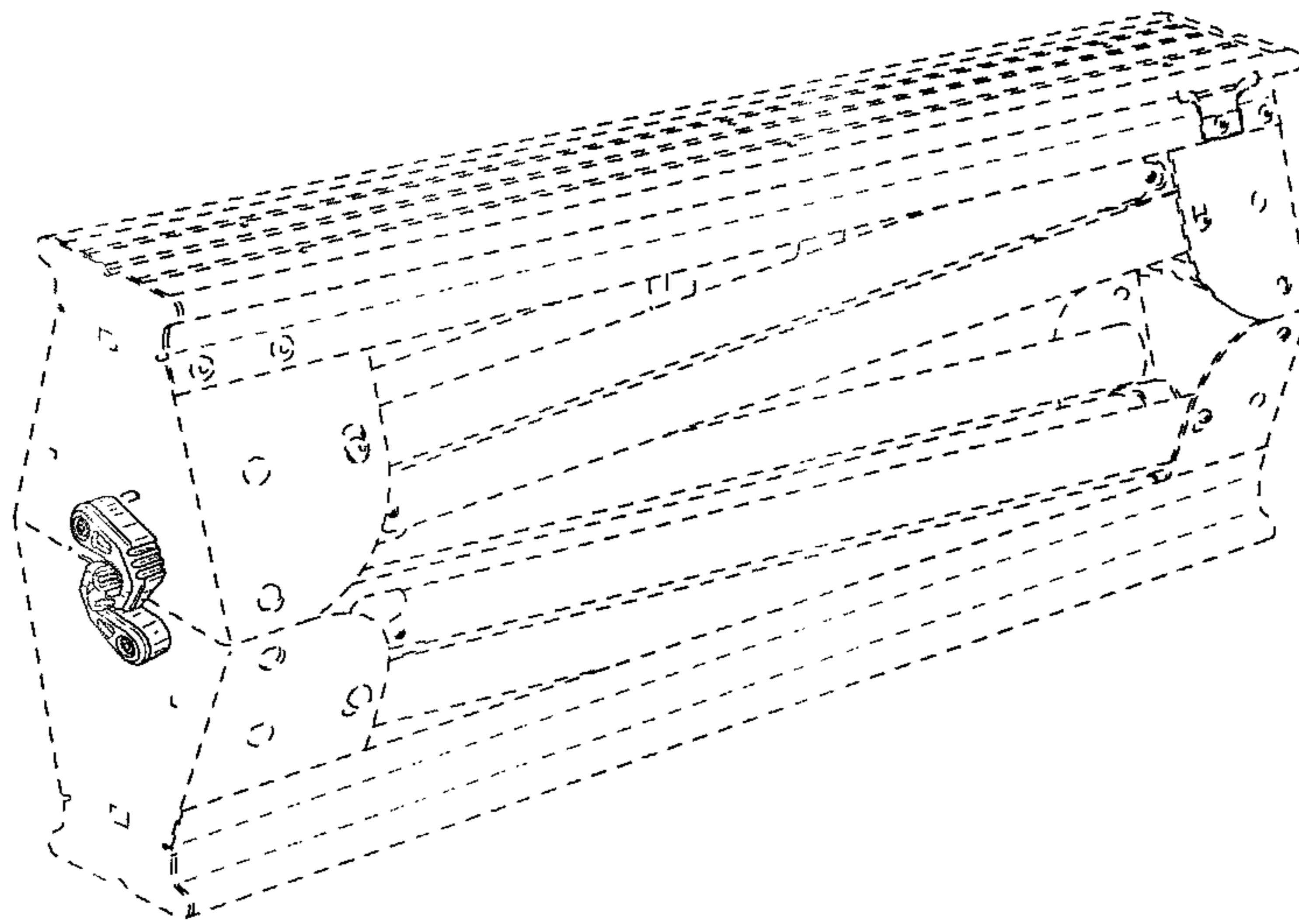

FIG. 1

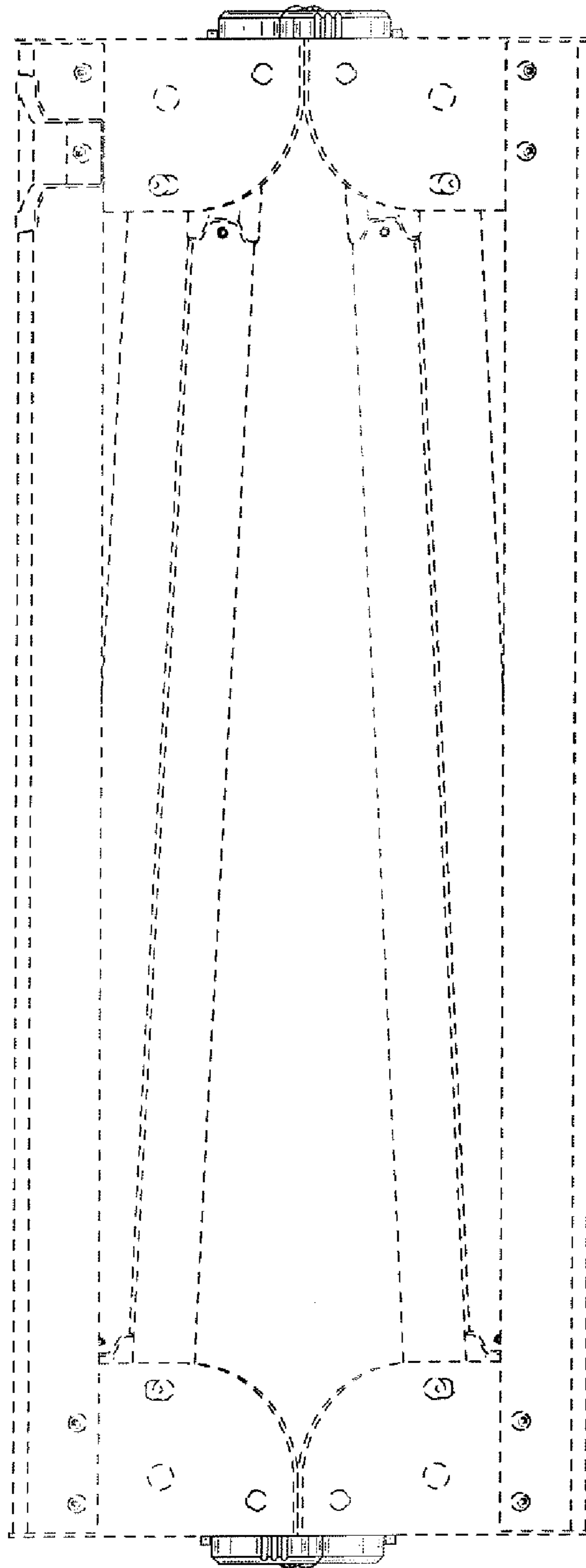

FIG. 2

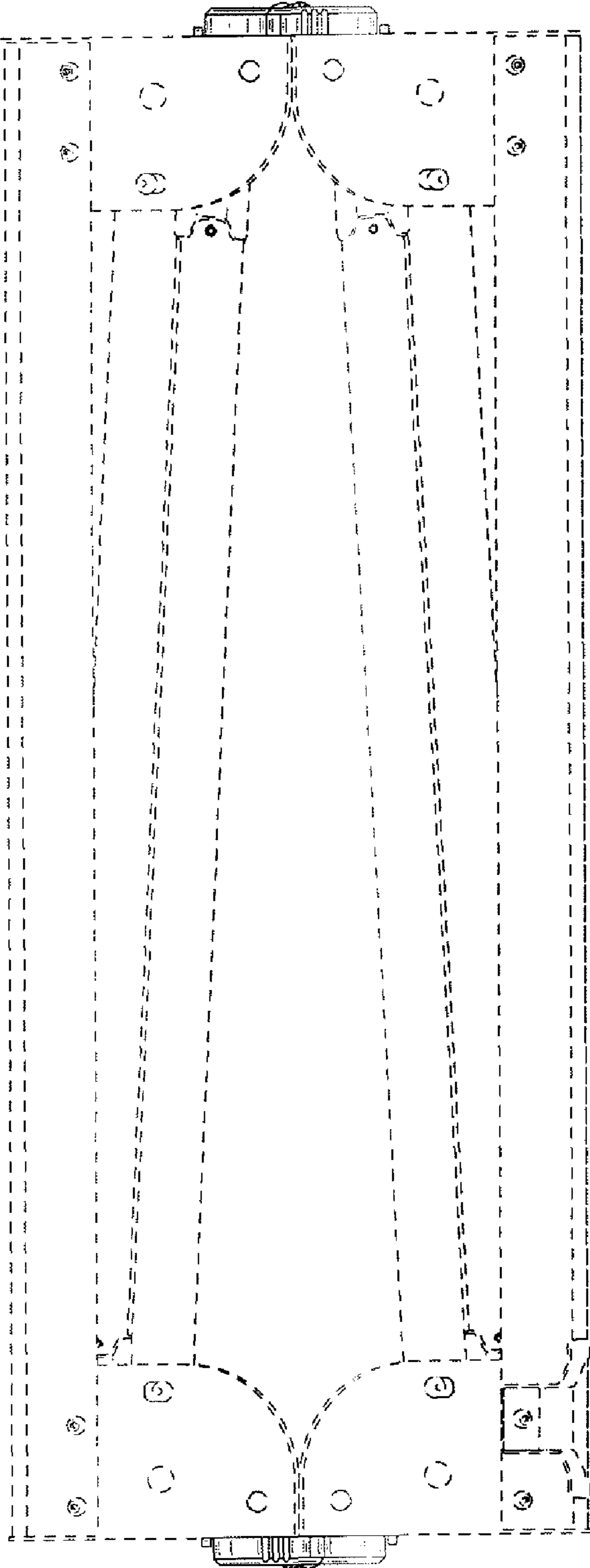

FIG. 3

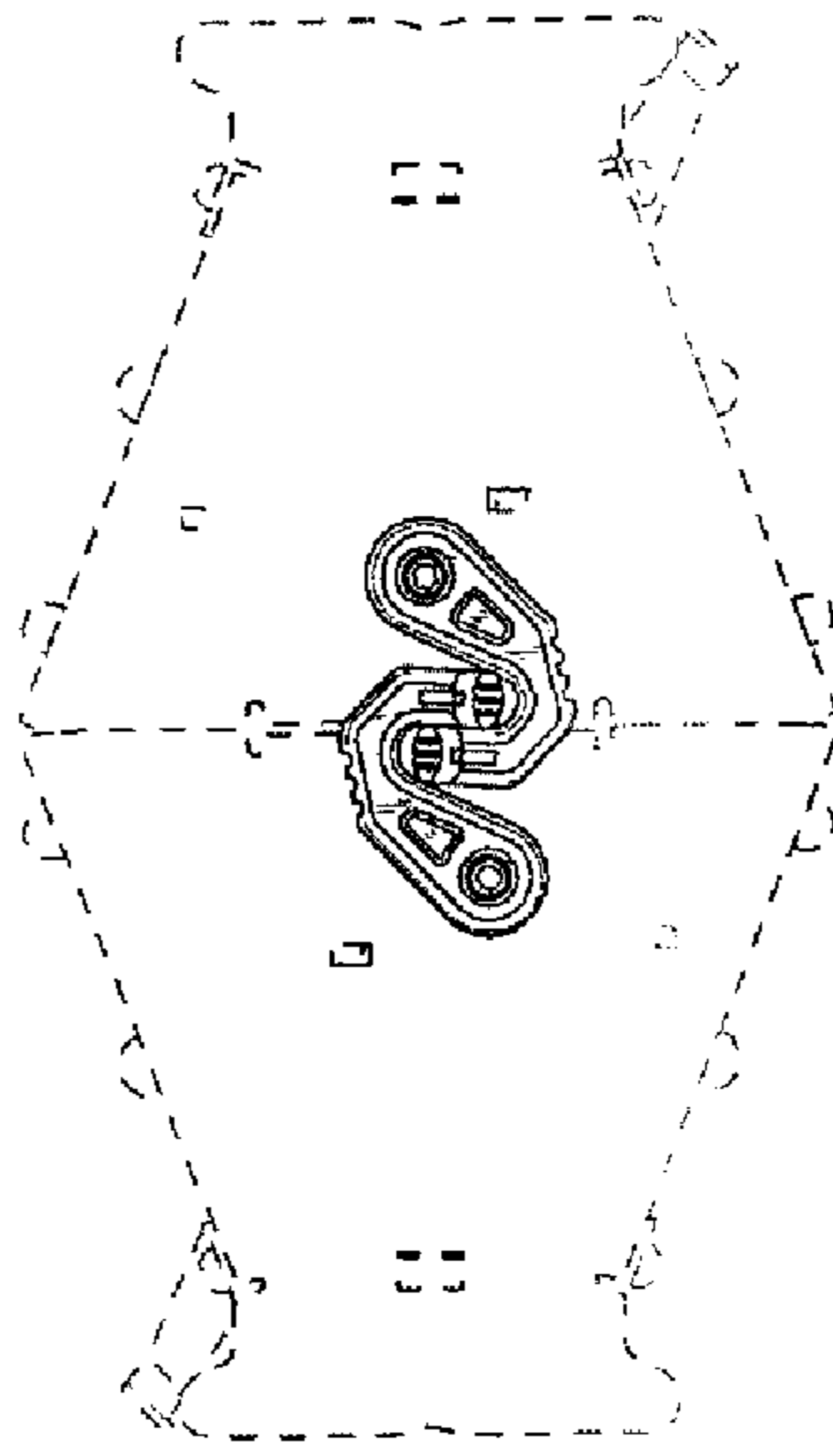

FIG. 4

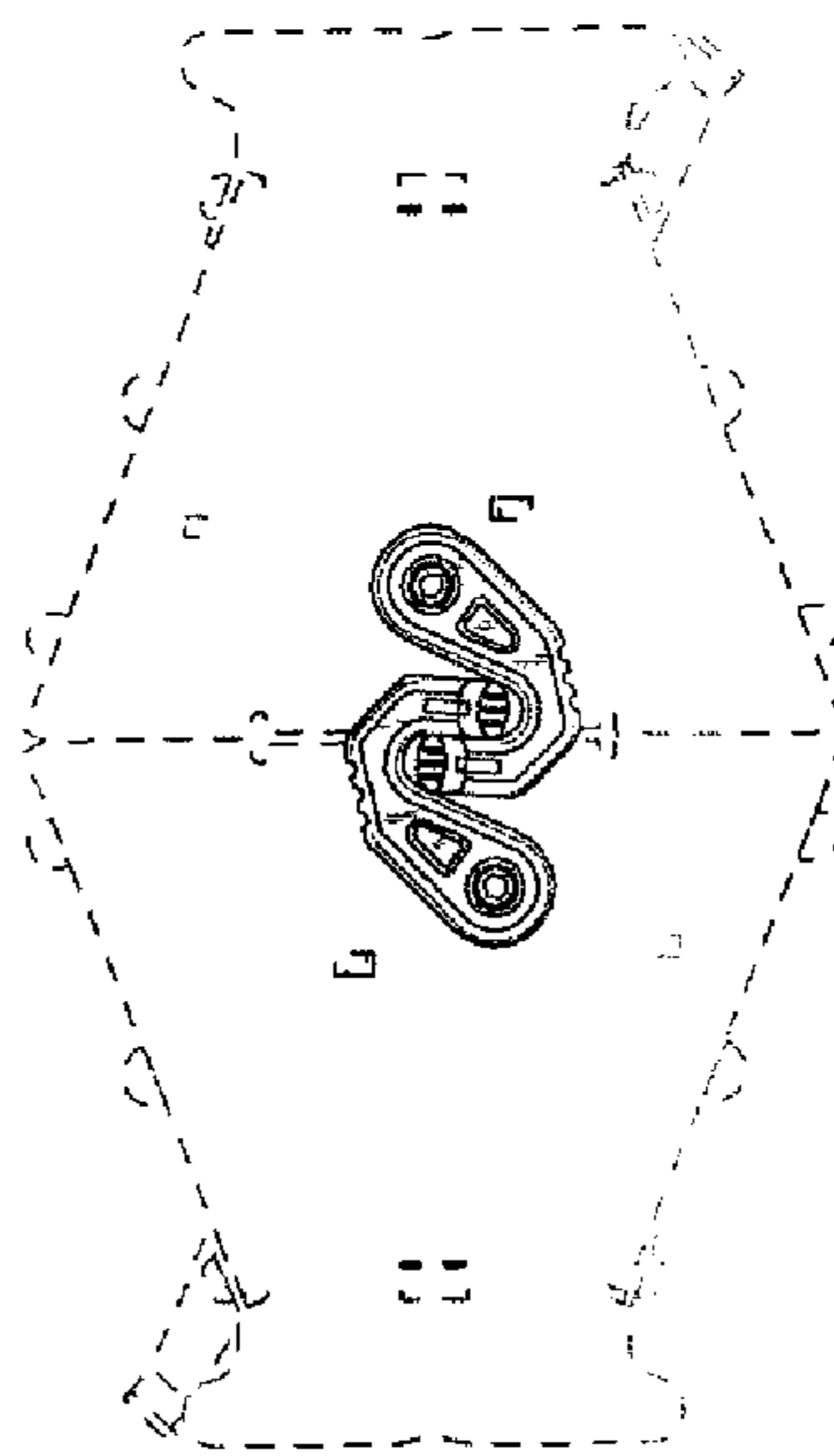

FIG. 5

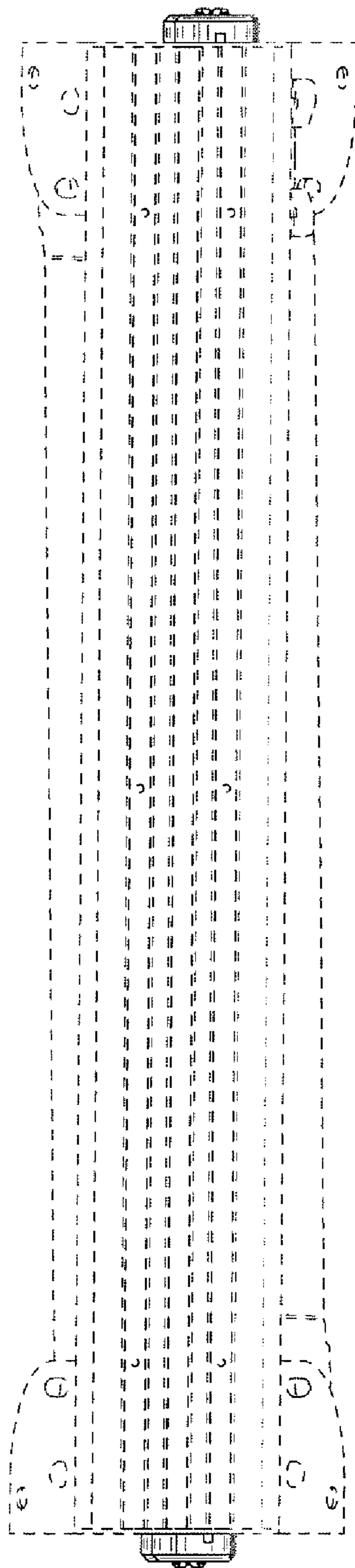

FIG. 6