



US00D648307S

(12) **United States Design Patent**
Choi et al.

(10) **Patent No.:** **US D648,307 S**
(45) **Date of Patent:** **** Nov. 8, 2011**

(54) **MOBILE PHONE**

(75) Inventors: **Woong Choi**, Seoul (KR); **Hyejin Kim**, Gyeonggi-do (KR); **Yunjin Park**, Seoul (KR); **Seungchul Cho**, Seoul (KR)

(73) Assignee: **LG Electronics Inc.**, Seoul (KR)

(**) Term: **14 Years**

(21) Appl. No.: **29/386,926**

(22) Filed: **Mar. 7, 2011**

(30) **Foreign Application Priority Data**

Sep. 10, 2010 (KR) 30-2010-0040069

(51) **LOC (9) Cl.** **14-03**

(52) **U.S. Cl.** **D14/138 AA**

(58) **Field of Classification Search** D14/138 AA,
D14/496, 341, 345, 346, 203.3, 203.4, 203.7,
D14/138 AB, 138 AD, 138 R, 147, 218, 137;
455/575.1, 556.2, 575.3, 575.4; D21/517;
379/433.01, 433.04, 433.11, 433.12, 433.13
See application file for complete search history.

(56) **References Cited**

U.S. PATENT DOCUMENTS

- D526,637 S * 8/2006 Shin D14/138 AA
- D542,764 S * 5/2007 Lee et al. D14/138 AA
- D543,182 S * 5/2007 Lee et al. D14/138 AA
- D543,184 S * 5/2007 Moon et al. D14/138 AA
- D543,186 S * 5/2007 Kim et al. D14/138 AA
- D546,802 S * 7/2007 Cho et al. D14/138 AA
- D573,970 S * 7/2008 Park D14/138 AA
- D576,993 S * 9/2008 Park et al. D14/138 AA
- D596,603 S * 7/2009 Tkachuk D14/138 AA
- D597,056 S * 7/2009 Tkachuk D14/138 AA
- D598,413 S * 8/2009 Chen D14/138 AA
- D608,758 S * 1/2010 Nahal et al. D14/138 AA
- D611,017 S * 3/2010 Loh et al. D14/138 AA
- D617,292 S * 6/2010 Chen et al. D14/138 AA
- D617,761 S * 6/2010 Wang D14/138 AA

- D620,466 S * 7/2010 Kim et al. D14/138 AA
- D628,186 S * 11/2010 Yang D14/138 AA
- D632,276 S * 2/2011 Chen D14/138 AA
- D636,366 S * 4/2011 Chen D14/138 AA
- D639,264 S * 6/2011 Tsai D14/138 AA

OTHER PUBLICATIONS

LG A120 telephone, announced Dec. 2010, [online], [site visited Aug. 23, 2011]. Available from Internet, <URL: <http://www.gsmarena.com>>.*

Sony Ericsson K510 telephone, announced Feb. 2006, [online], [site visited Aug. 23, 2011]. Available from Internet, <URL: <http://www.gsmarena.com>>.*

Motorola W233 telephone, announced Jan. 2009, [online], [site visited Aug. 23, 2011]. Available from Internet, <URL: <http://www.gsmarena.com>>.*

Vodafone 226 telephone, announced Jul. 2007, [online], [site visited Aug. 23, 2011]. Available from Internet, <URL: <http://www.gsmarena.com>>.*

Alcatel OT-300 telephone, announced Feb. 2010, [online], [site visited Aug. 23, 2011]. Available from Internet, <URL: <http://www.gsmarena.com>>.*

* cited by examiner

Primary Examiner — Jeffrey D Asch

(74) *Attorney, Agent, or Firm* — Morgan, Lewis & Bockius LLP

(57) **CLAIM**

The ornamental design for a mobile phone, as shown and described.

DESCRIPTION

FIG. 1 is a perspective view of a mobile phone showing our new design;

FIG. 2 is a front view thereof;

FIG. 3 is a rear view thereof;

FIG. 4 is a left side view thereof;

FIG. 5 is a right side view thereof;

FIG. 6 is a top plan view thereof; and,

FIG. 7 is a bottom plan view thereof.

1 Claim, 6 Drawing Sheets

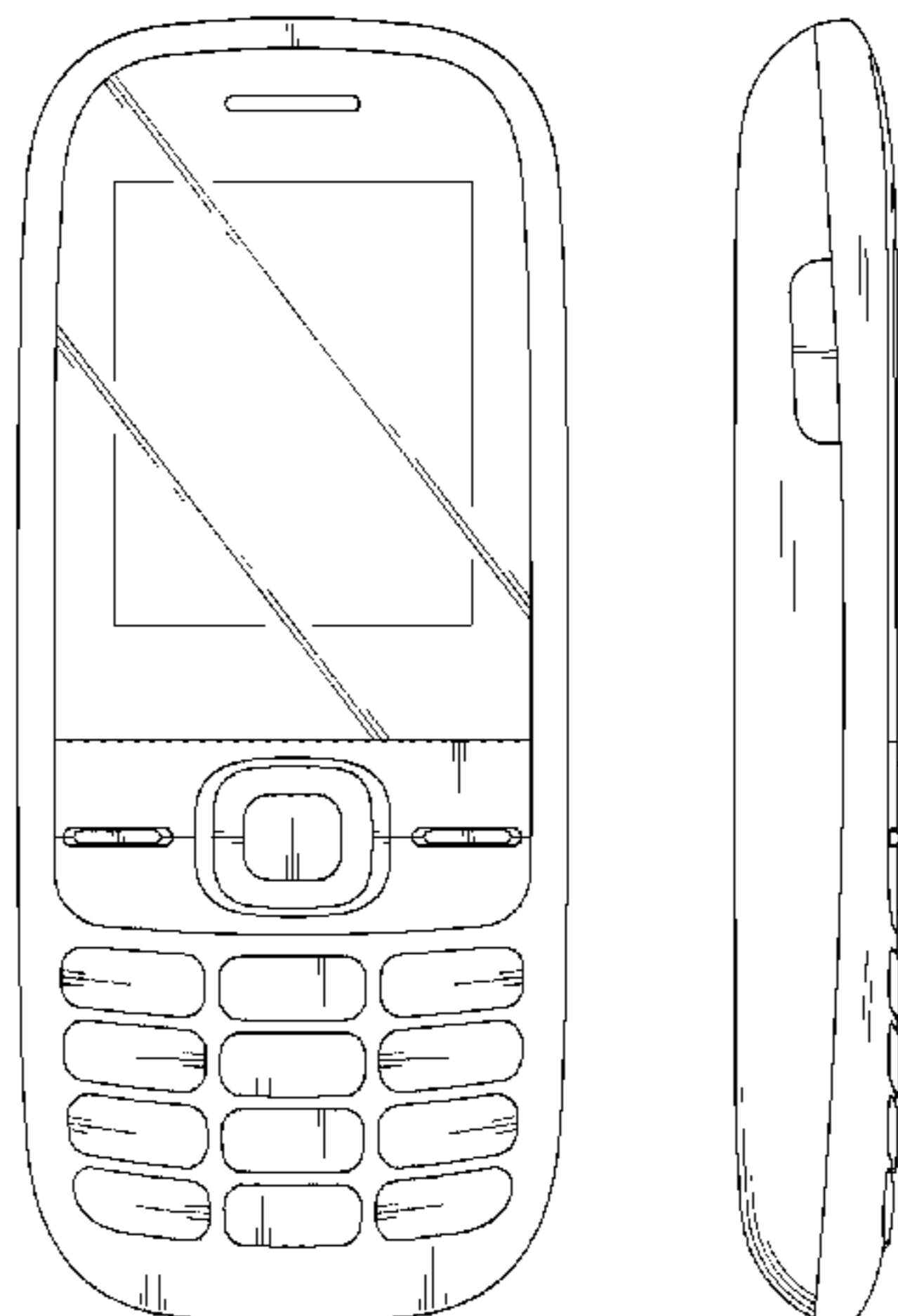

FIG. 1

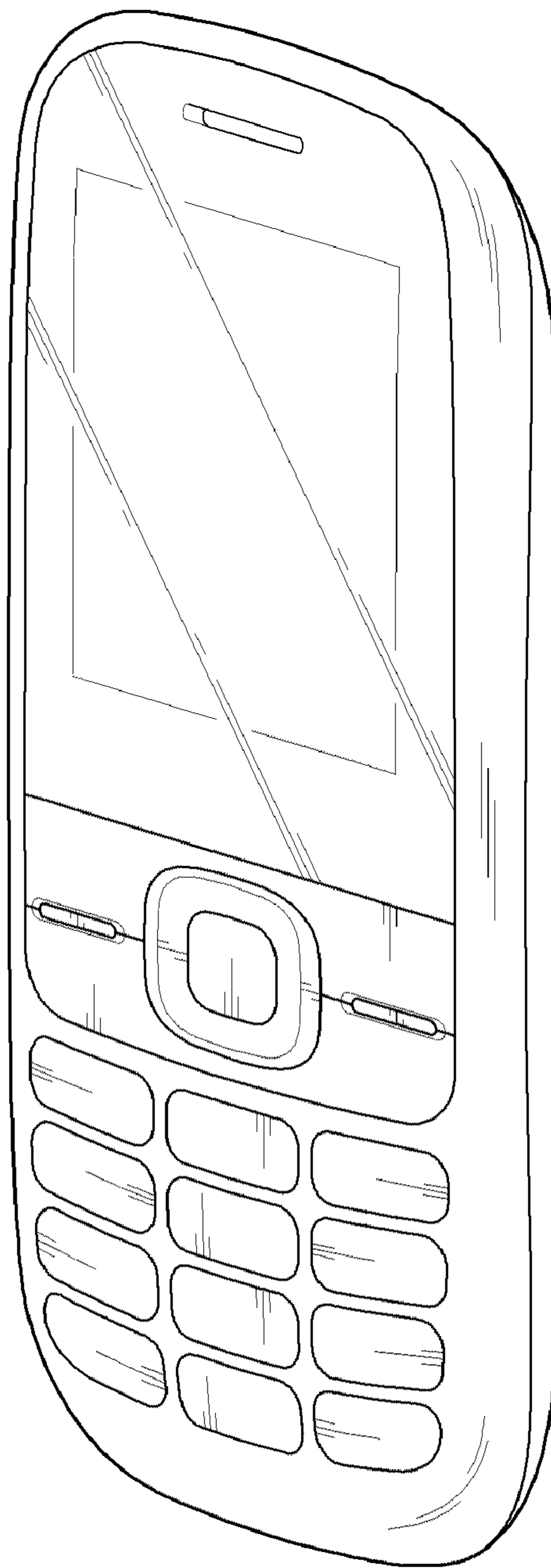

FIG. 2

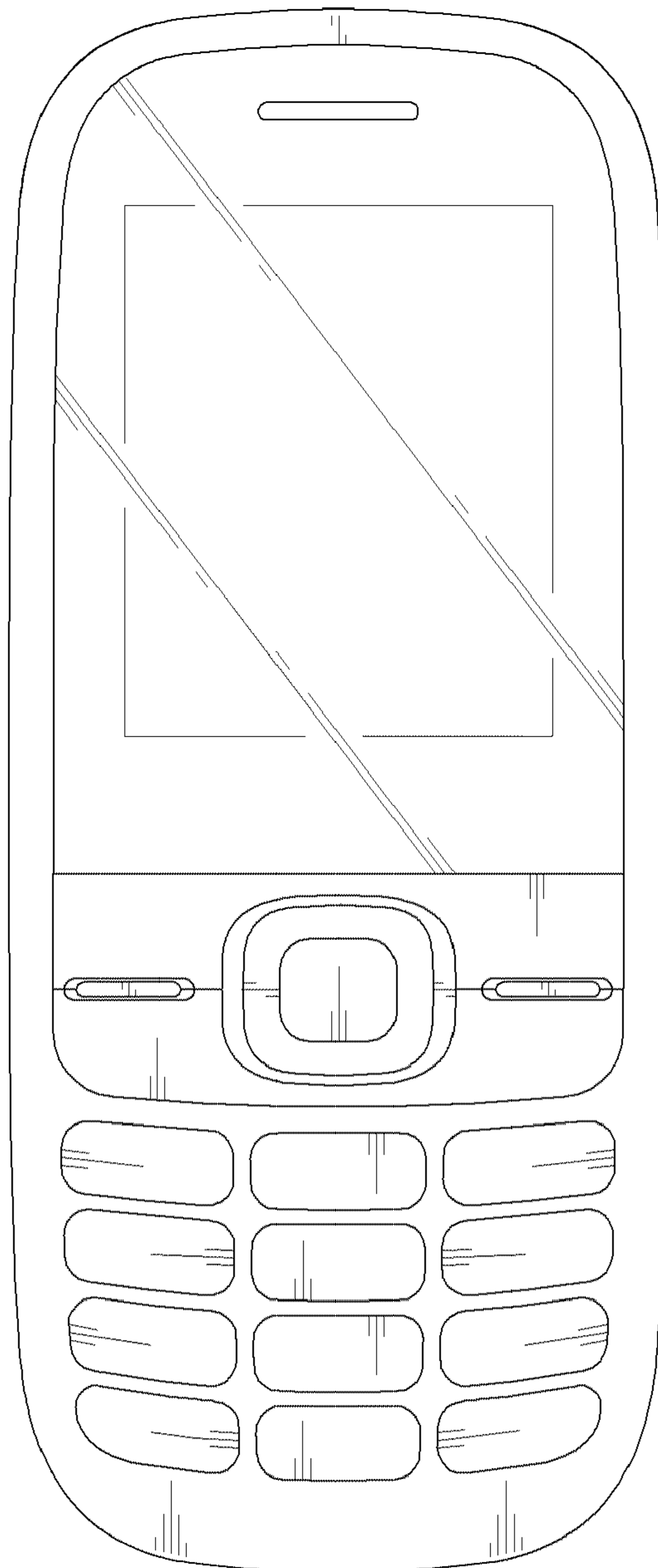

FIG. 3

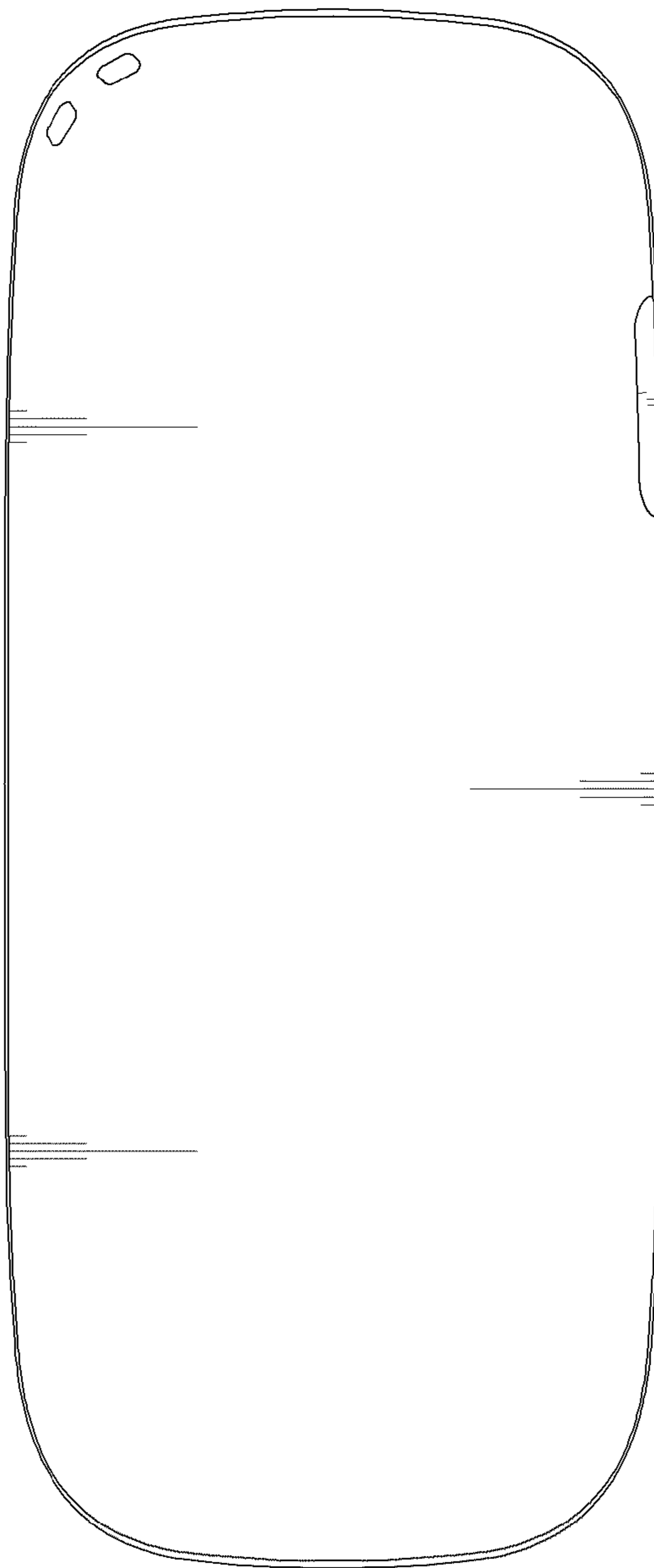

FIG. 4

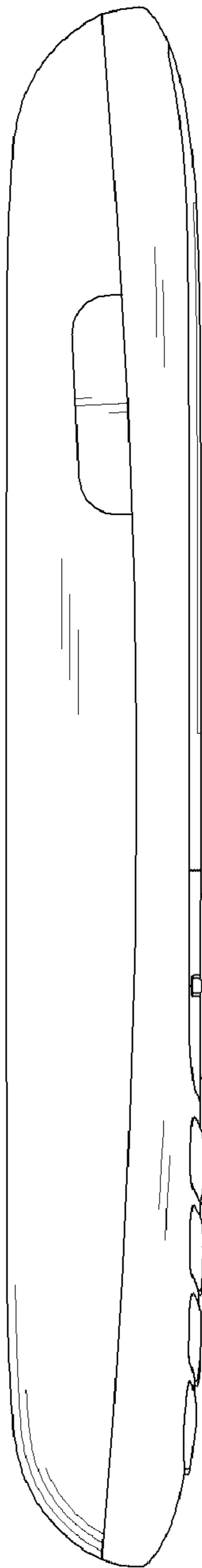

FIG. 5

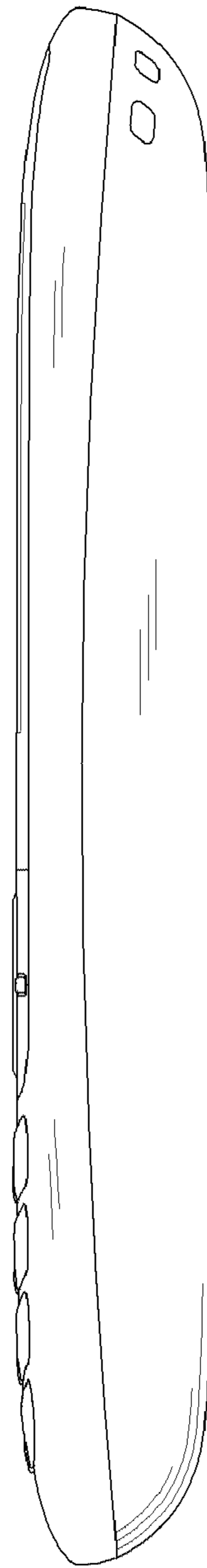

FIG. 6

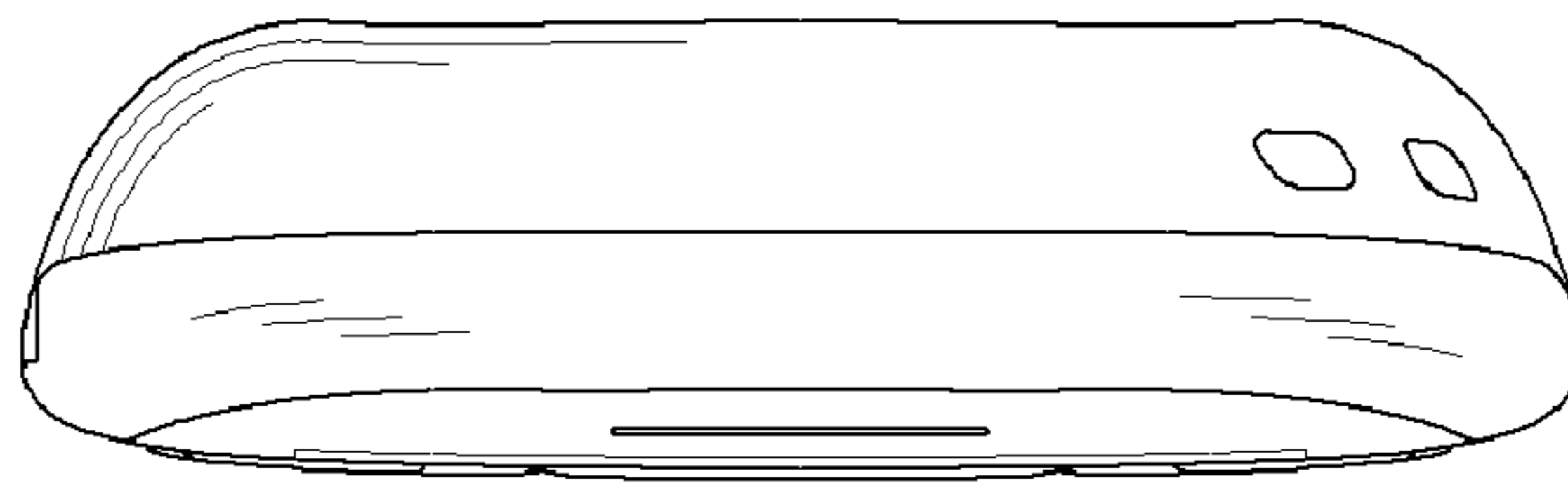

FIG. 7

