



US00D648120S

(12) **United States Design Patent**  
**Gonzalez**

(10) **Patent No.:** **US D648,120 S**

(45) **Date of Patent:** **\*\* Nov. 8, 2011**

(54) **HANDBAG**

(75) Inventor: **Alvaro Gonzalez**, Florence (IT)

(73) Assignee: **J. Choo Limited**, London (GB)

(\*\*) Term: **14 Years**

(21) Appl. No.: **29/349,980**

(22) Filed: **May 25, 2010**

(30) **Foreign Application Priority Data**

Nov. 25, 2009 (EM) ..... 001181986-0014  
Nov. 25, 2009 (EM) ..... 001181986-0015

(51) **LOC (9) Cl.** ..... **03-01**

(52) **U.S. Cl.** ..... **D3/232**

(58) **Field of Classification Search** ..... D3/232-233,  
D3/240-246; 150/100, 103-110, 113-114,  
150/118-119

See application file for complete search history.

(56) **References Cited**

**U.S. PATENT DOCUMENTS**

D135,816 S 6/1943 Appel  
5,503,204 A 4/1996 Byers et al.

6,179,025 B1 1/2001 Sutton  
D582,665 S \* 12/2008 Gonzalez ..... D3/232  
D596,847 S \* 7/2009 Nelson ..... D3/232

\* cited by examiner

*Primary Examiner* — Holly Baynham

(74) *Attorney, Agent, or Firm* — Fross Zelnick Lehrman & Zissu, P.C.; Lawrence E. Apolzon, Esq.

(57) **CLAIM**

The ornamental design for a handbag, as shown and described.

**DESCRIPTION**

FIG. 1 is a front perspective view of a handbag showing my new design, shown in a closed position;  
FIG. 2 is a front view of the handbag shown in FIG. 1 (with the rear view being a mirror image thereof);  
FIG. 3 is a left side view of the handbag shown in FIG. 1 (with the right side view being a mirror image thereof);  
FIG. 4 is a top view of the handbag shown in FIG. 1;  
FIG. 5 is a bottom view of the handbag shown in FIG. 1; and,  
FIG. 6 is a front perspective view of the handbag shown in FIG. 1, shown in an open position.  
The broken lines in FIG. 6 indicate the functional alignment of the upper and lower portions of the claimed handbag and form no part of the claim.

**1 Claim, 6 Drawing Sheets**

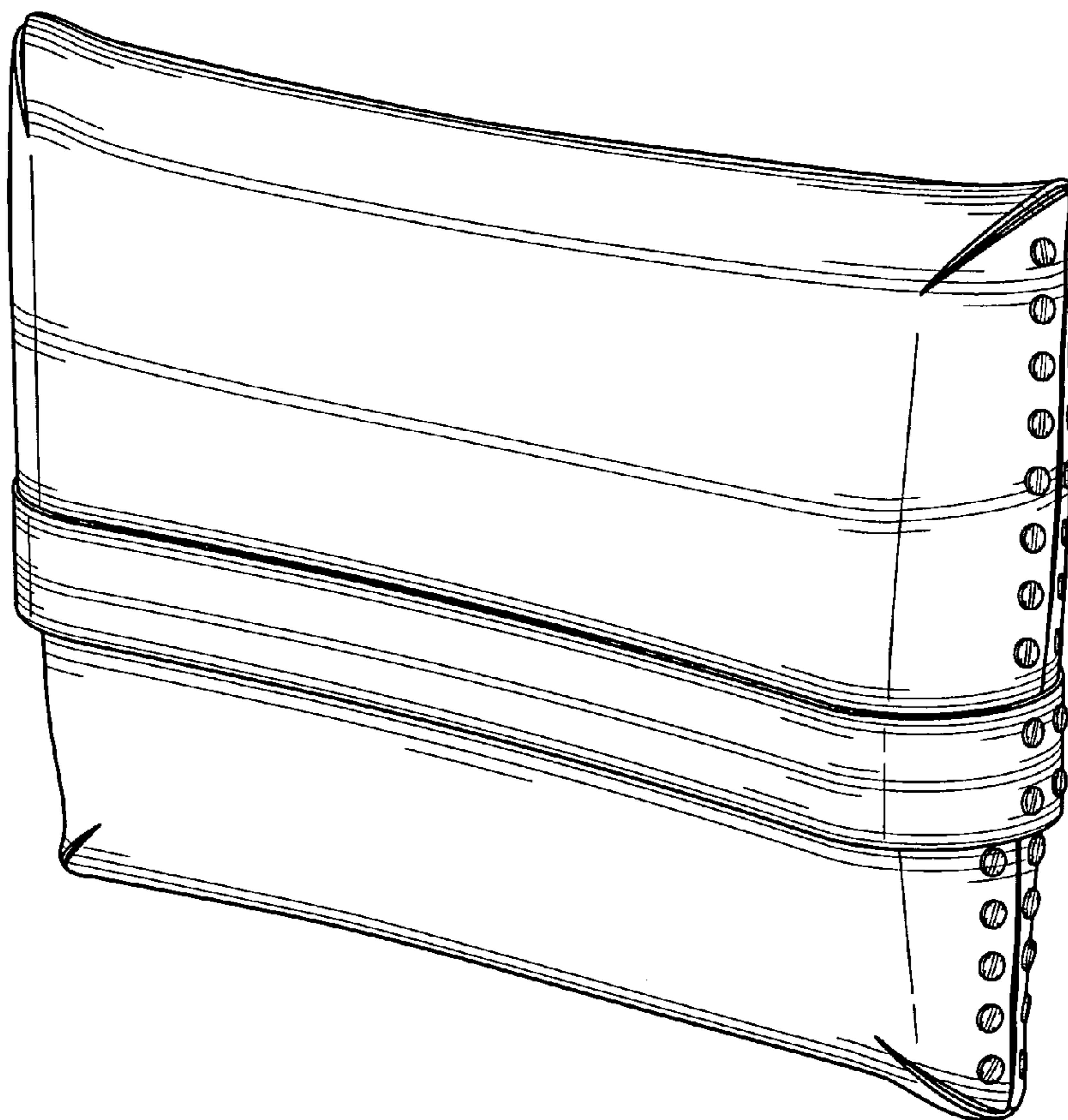

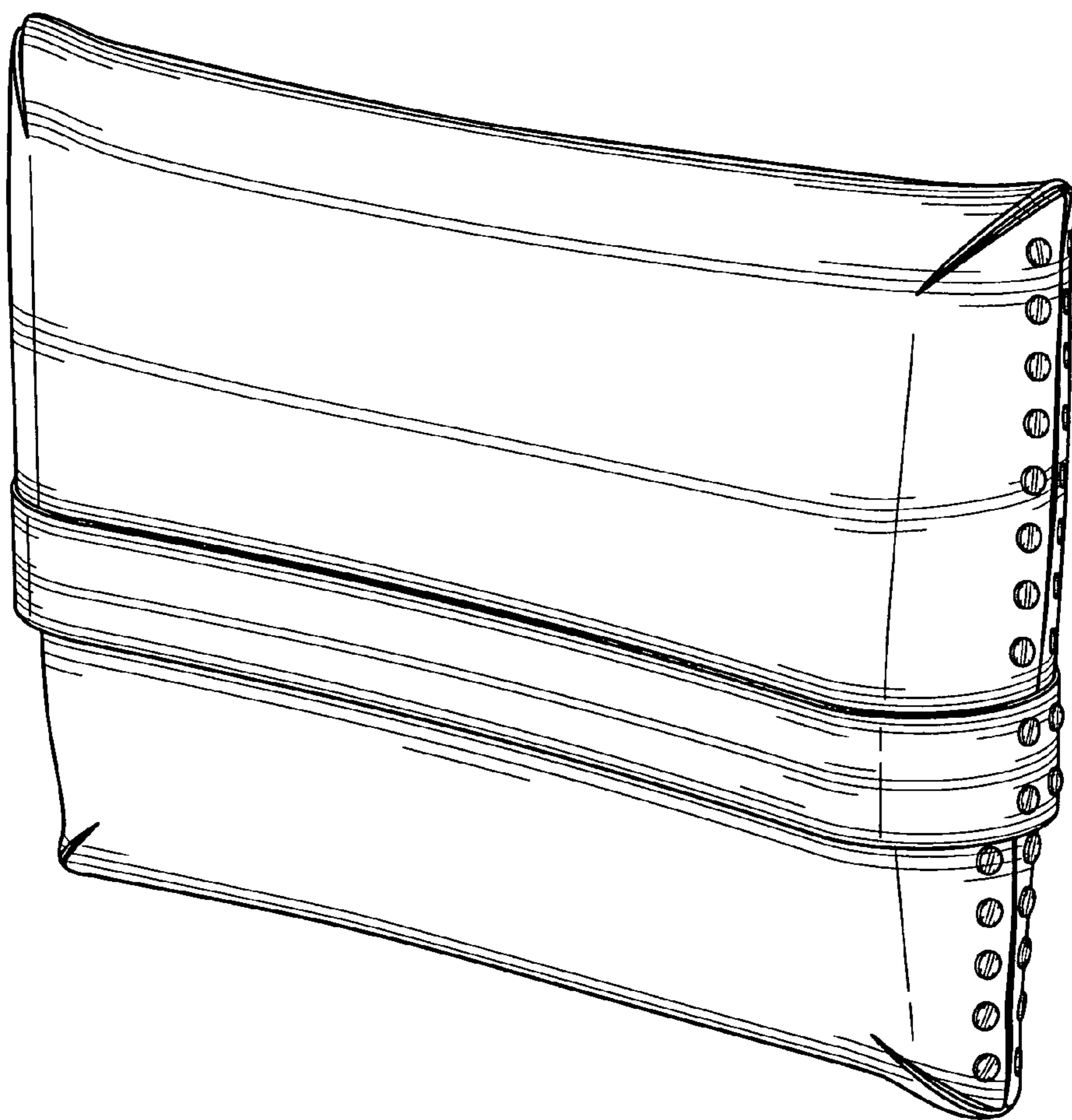

FIG. 1

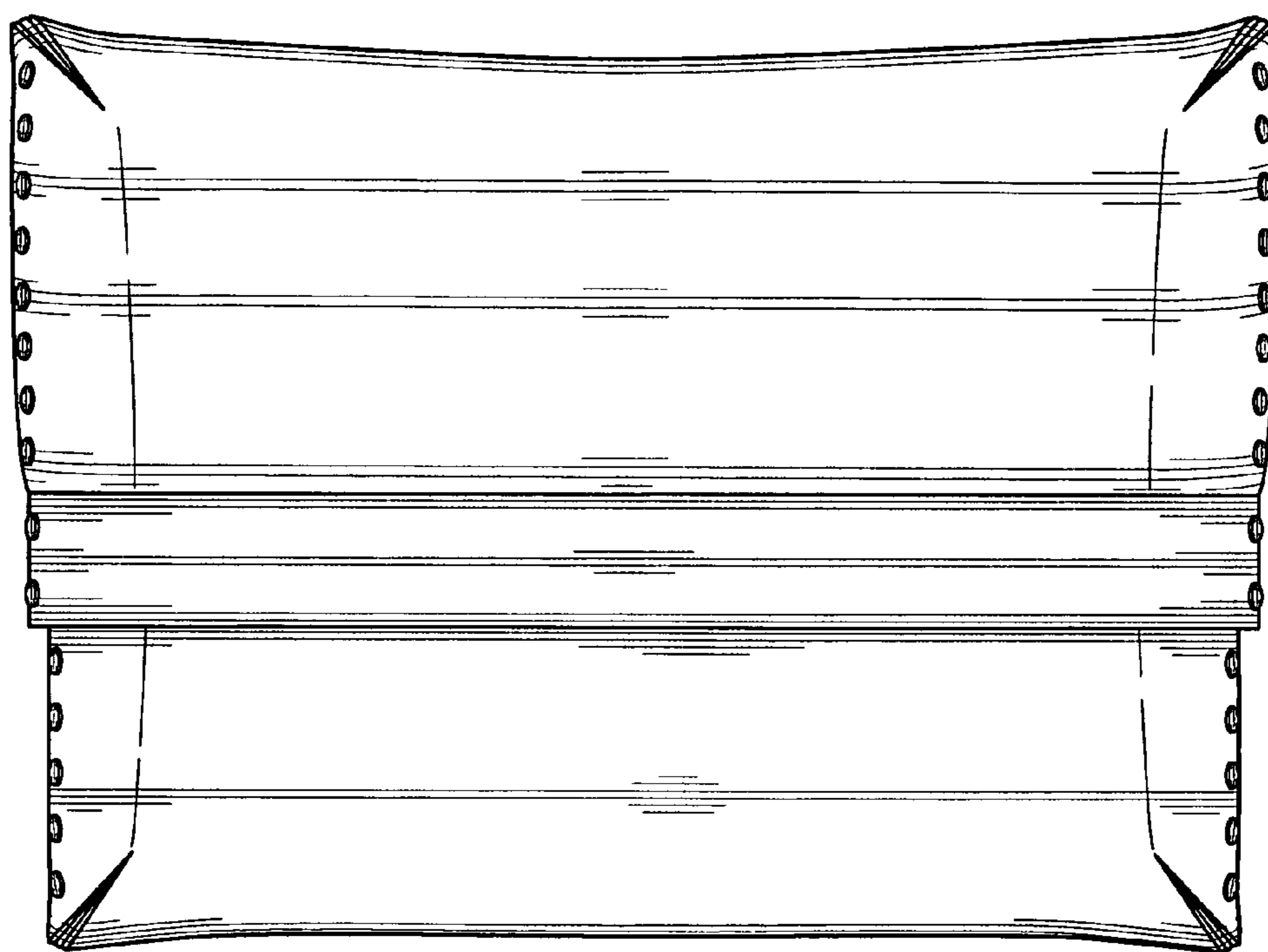

FIG. 2

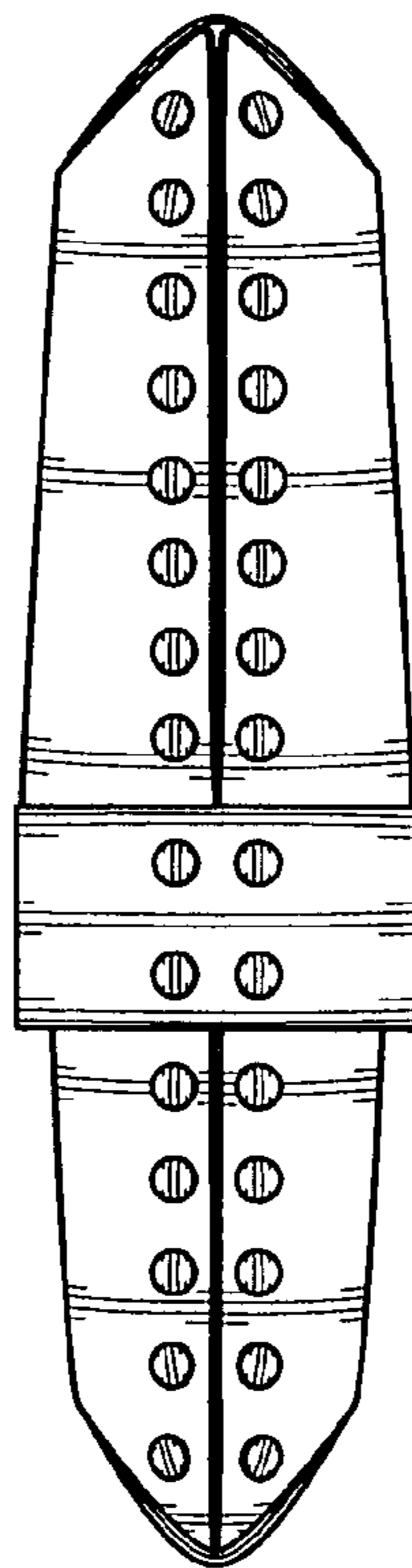

FIG. 3

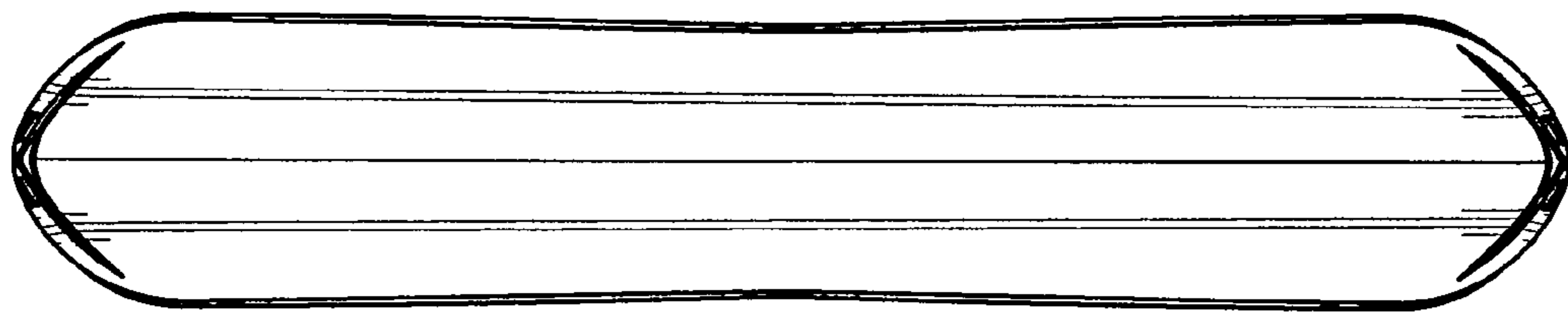

FIG. 4

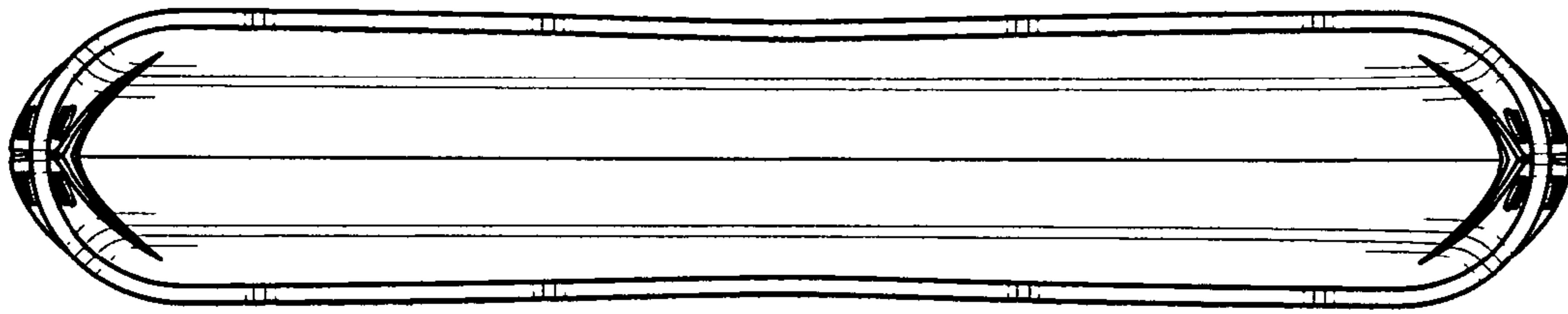

FIG. 5

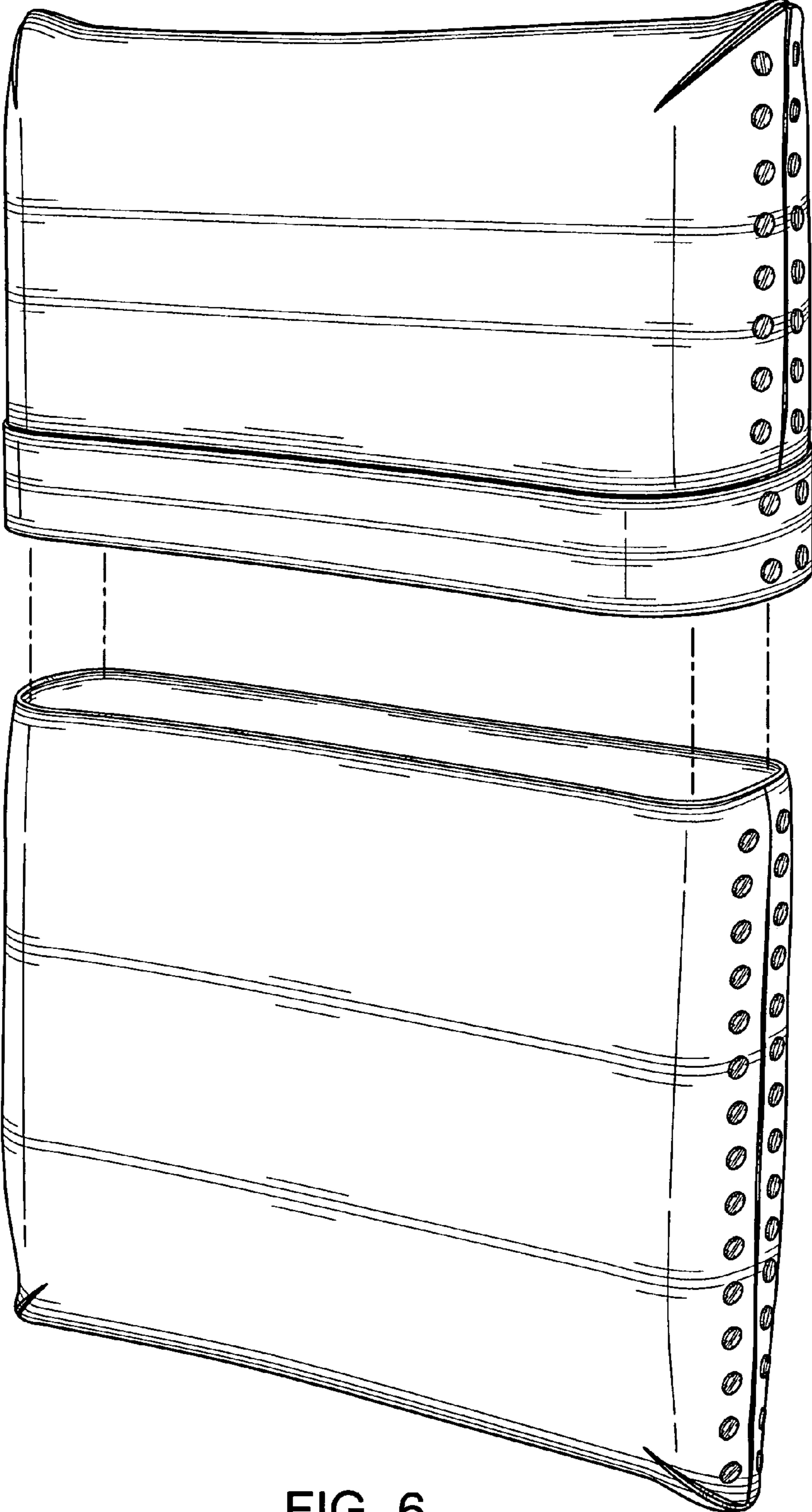

FIG. 6