



US00D648043S

(12) **United States Design Patent**
Kim et al.

(10) **Patent No.:** **US D648,043 S**

(45) **Date of Patent:** **** Nov. 1, 2011**

(54) **PORTION OF A LED LAMP**

(56) **References Cited**

(75) Inventors: **Jihoo Kim**, Seoul (KR); **Tae Young Choi**, Seoul (KR); **Dong Nyung Lim**, Seoul (KR); **Sung Ho Kim**, Seoul (KR); **Cheonjoo Kim**, Seoul (KR)

U.S. PATENT DOCUMENTS

D541,440	S	*	4/2007	Feit	D26/2
D581,556	S	*	11/2008	To et al.	D26/2
D590,523	S	*	4/2009	Takahashi	D26/2
D598,143	S	*	8/2009	Gerritsen	D26/2
D600,368	S	*	9/2009	Bertram et al.	D26/2
D602,614	S	*	10/2009	Takahashi et al.	D26/2
D626,257	S	*	10/2010	Pickard	D26/2

(73) Assignee: **LG Innotek Co., Ltd.**, Seoul (KR)

* cited by examiner

(**) Term: **14 Years**

Primary Examiner — Marcus Jackson

(74) *Attorney, Agent, or Firm* — Lowe Hauptman Ham & Berner LLP

(21) Appl. No.: **29/389,809**

(57) **CLAIM**

The ornamental design for a portion of a LED lamp, as shown and described.

(22) Filed: **Apr. 18, 2011**

DESCRIPTION

(30) **Foreign Application Priority Data**

Oct. 22, 2010 (KR) 30-2010-0045768

(51) **LOC (9) Cl.** **26-04**

(52) **U.S. Cl.** **D26/2**

(58) **Field of Classification Search** D26/1-4;
313/313, 315, 316, 317, 318, 493; 315/52,
315/53, 56, 57, 58

FIG. 1 is a perspective view of a portion of a LED lamp showing my/our new design;
FIG. 2 is a front elevational view thereof;
FIG. 3 is a rear elevational view thereof;
FIG. 4 is a left side elevational view thereof;
FIG. 5 is a right side elevational view thereof;
FIG. 6 is a top plan view thereof; and,
FIG. 7 is a bottom plan view thereof.
LED is installed in the light emitting part.

See application file for complete search history.

1 Claim, 4 Drawing Sheets

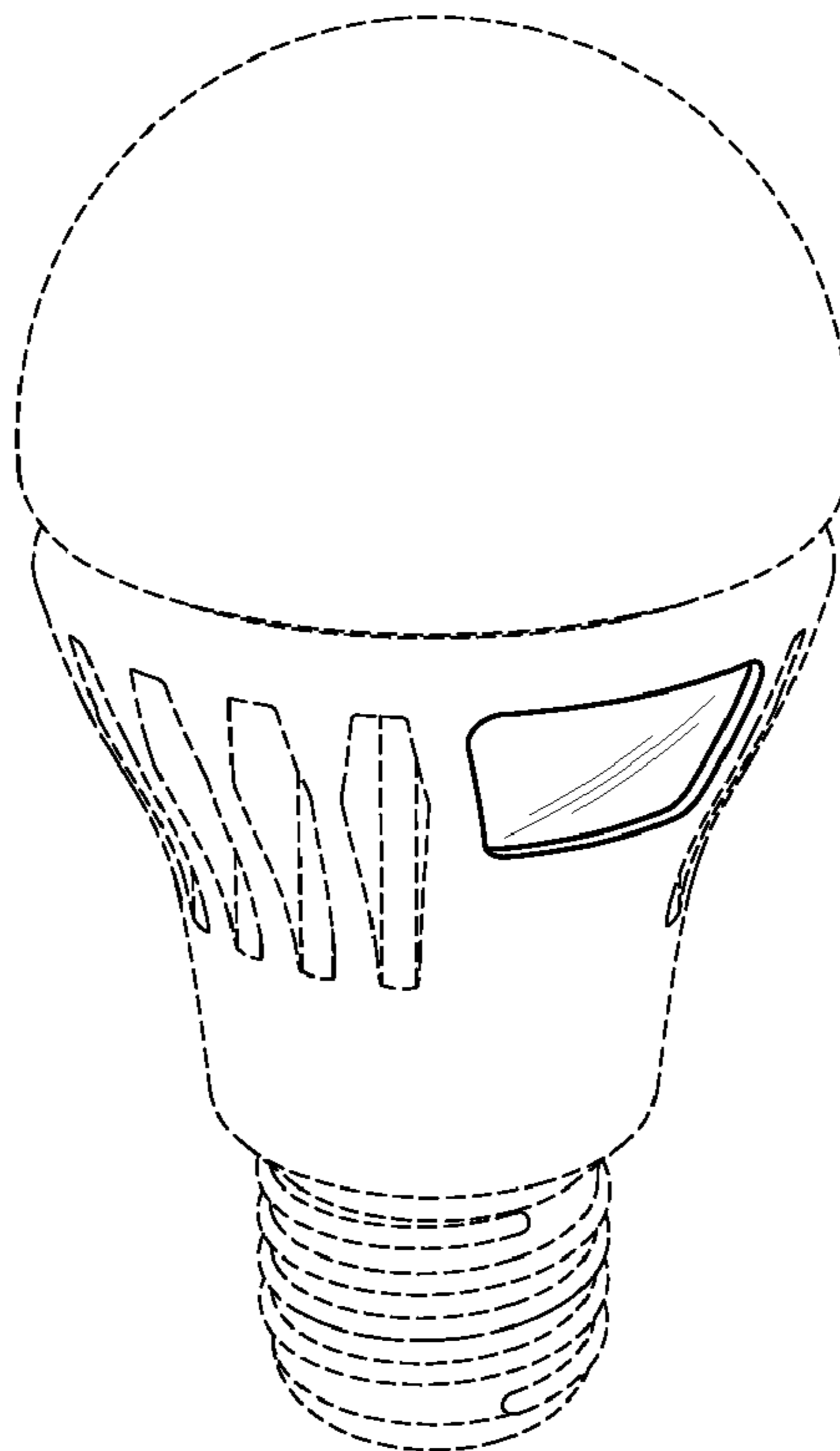

FIG. 1

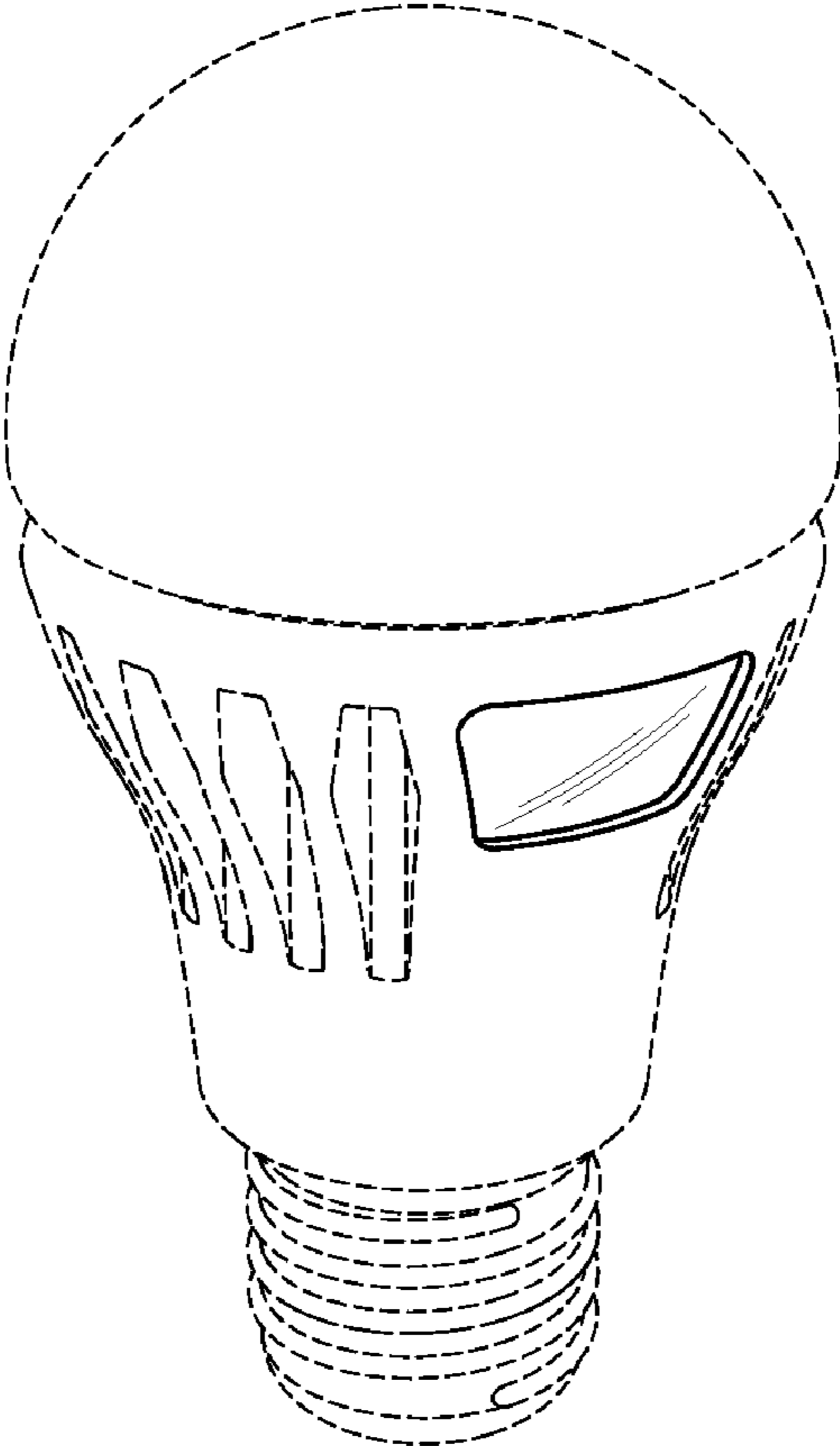

FIG. 2

FIG. 3

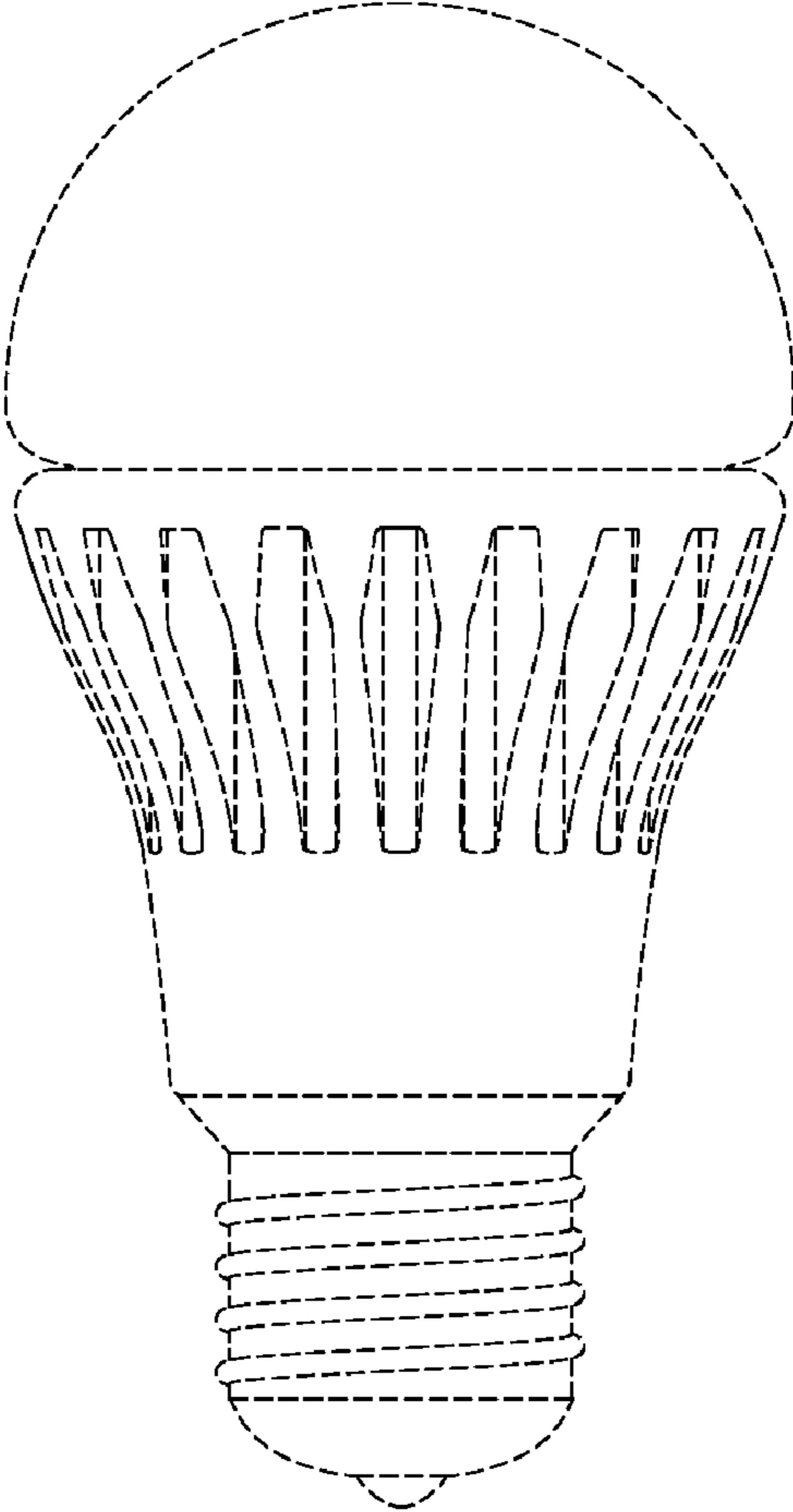
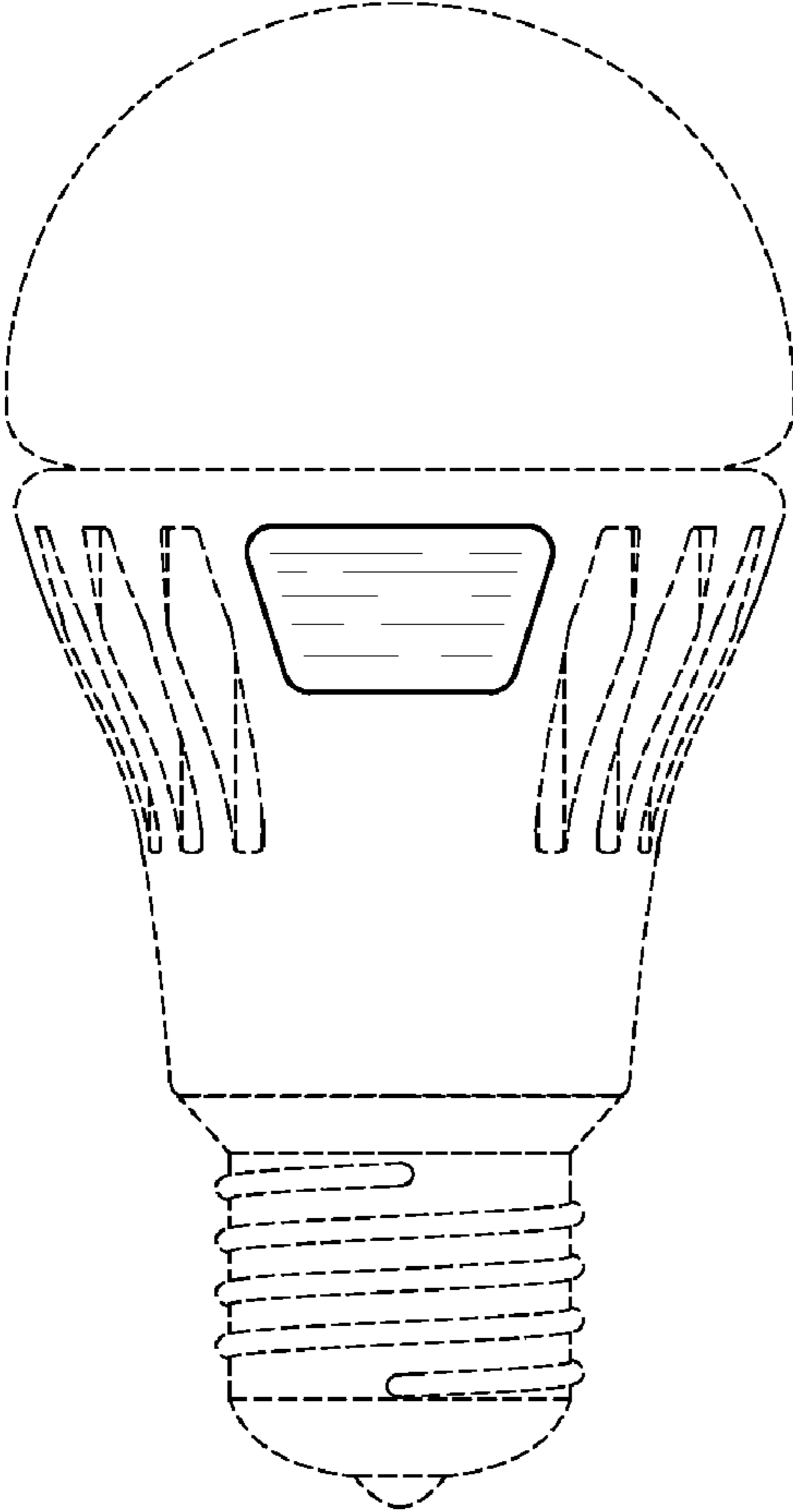

FIG. 4

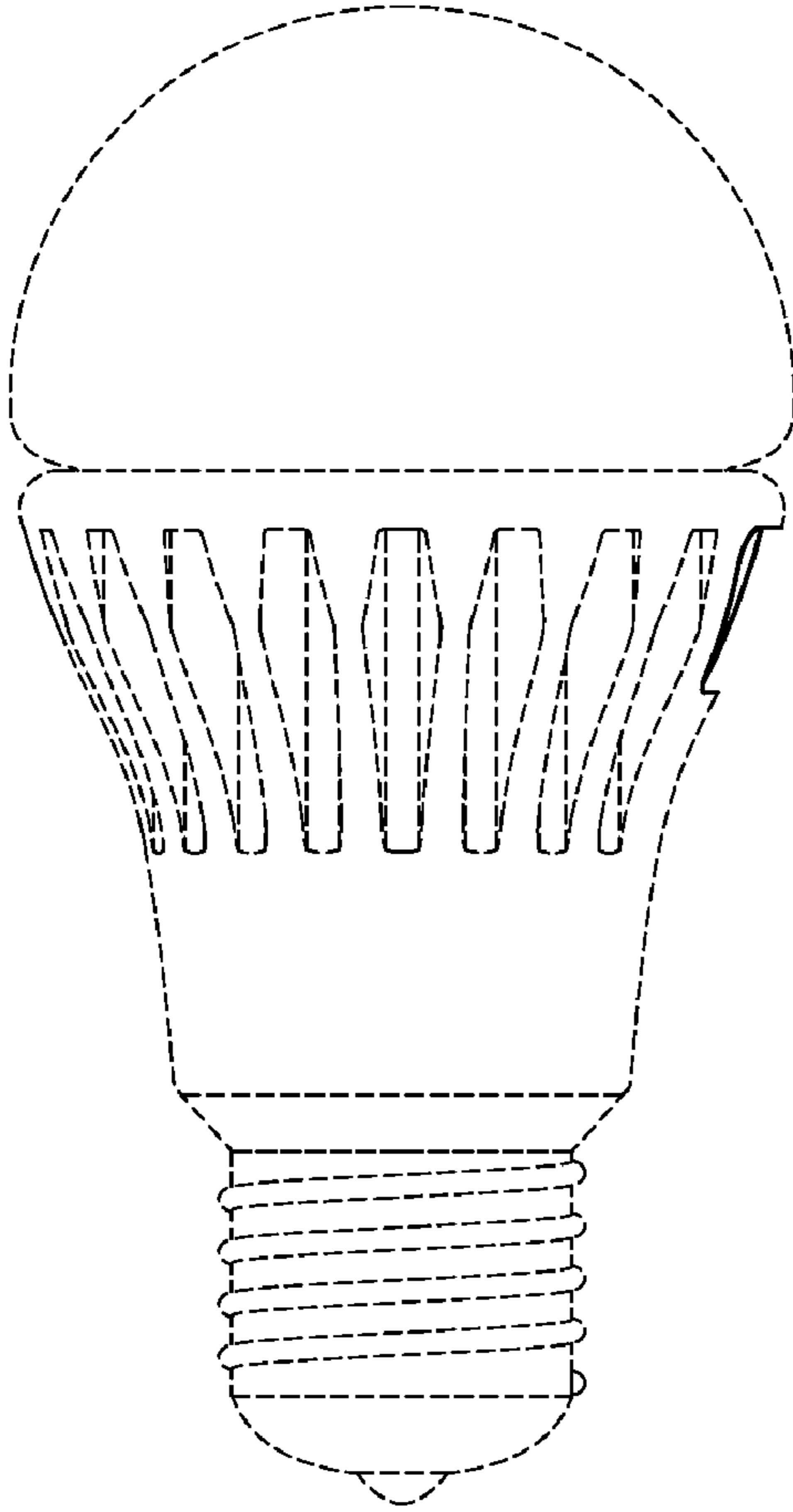

FIG. 5

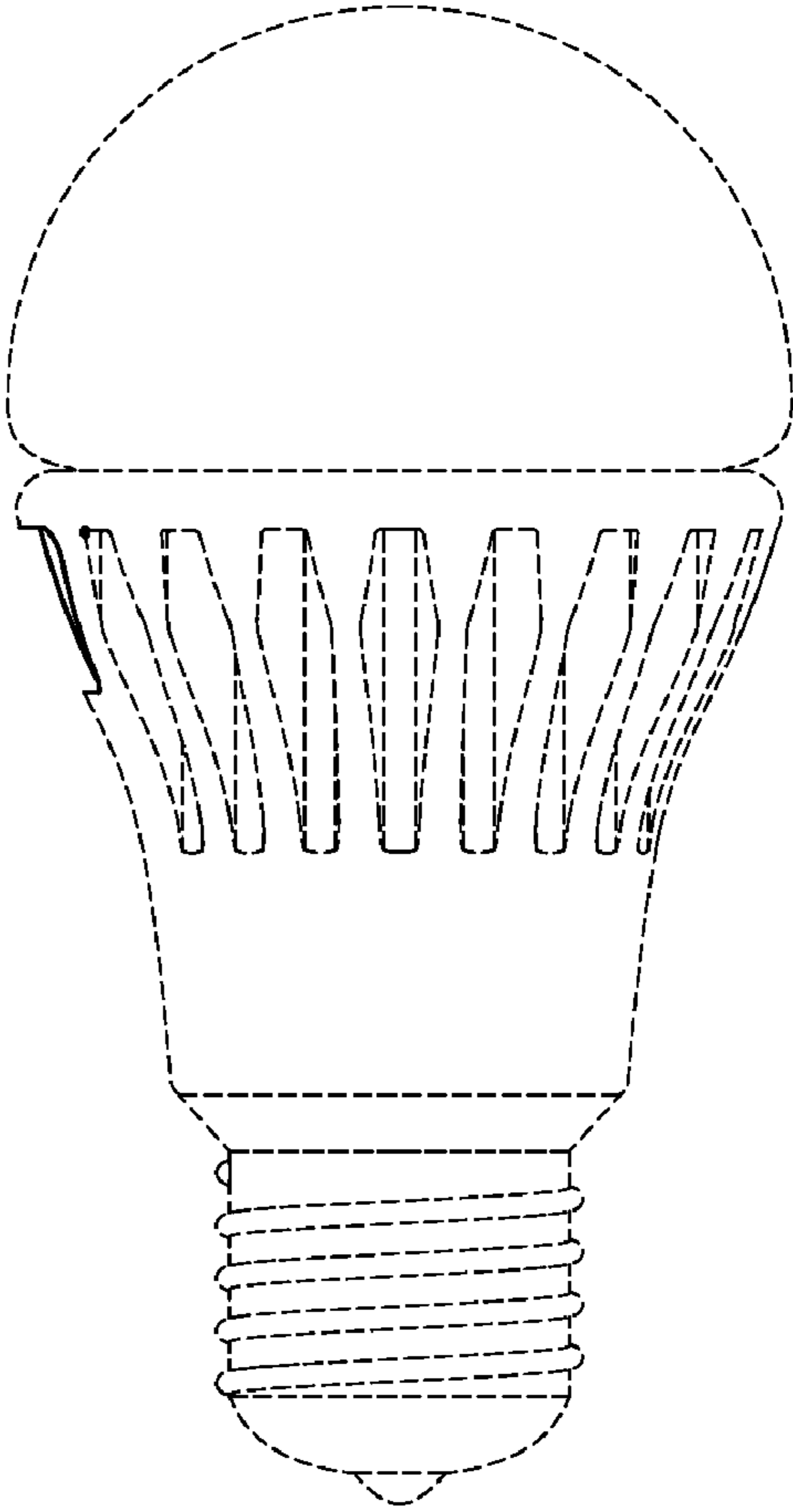

FIG. 6

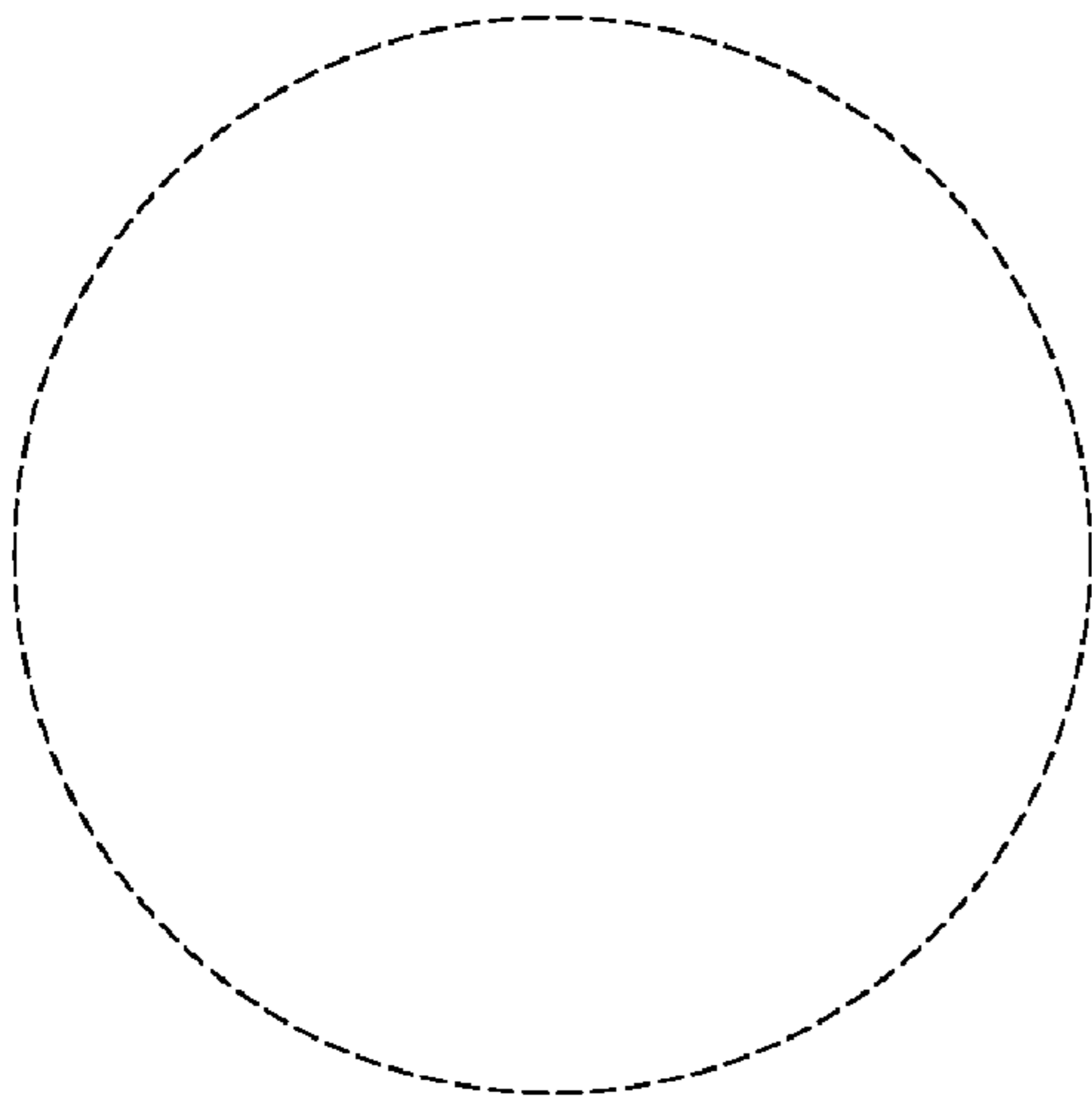

FIG. 7

