

US00D648001S

(12) **United States Design Patent**
Kobayashi et al.

(10) **Patent No.:** **US D648,001 S**

(45) **Date of Patent:** **** Nov. 1, 2011**

(54) **EXPANSION VALVE**

(75) Inventors: **Kazuto Kobayashi**, Tokyo (JP); **Takashi Mogi**, Tokyo (JP)

(73) Assignee: **Fujikoki Corporation**, Tokyo (JP)

(**) Term: **14 Years**

(21) Appl. No.: **29/371,561**

(22) Filed: **Apr. 25, 2011**

(30) **Foreign Application Priority Data**

Dec. 7, 2010 (JP) 2010-029126

(51) **LOC (9) Cl.** **23-01**

(52) **U.S. Cl.** **D23/233**

(58) **Field of Classification Search** D23/233-237,
D23/244-249; 137/625.48; 251/14, 64;
62/115, 197, 210, 222-225, 527; 236/63-64,
236/66, 92 B; 285/189, 208, 211, 368
See application file for complete search history.

(56) **References Cited**

U.S. PATENT DOCUMENTS

D427,285 S * 6/2000 Watanabe D23/233
D429,315 S * 8/2000 Okada et al. D23/233
D440,632 S * 4/2001 Fukuda et al. D23/233
D494,658 S * 8/2004 Kobayashi et al. D23/233
D532,080 S * 11/2006 Kobayashi et al. D23/233
D546,921 S * 7/2007 Kobayashi et al. D23/233

D589,118 S * 3/2009 Watanabe D23/233
D601,662 S * 10/2009 Kobayashi et al. D23/233
D602,560 S * 10/2009 Shimura et al. D23/233
D621,475 S * 8/2010 Matsumoto D23/233

* cited by examiner

Primary Examiner — Cathron C. Brooks

Assistant Examiner — Maurice Stevens

(74) *Attorney, Agent, or Firm* — Manabu Kanesaka

(57) **CLAIM**

The ornamental design for an expansion valve, as shown and described.

DESCRIPTION

FIG. 1 is a front perspective view of an expansion valve showing our new design;

FIG. 2 is a rear perspective view thereof;

FIG. 3 is a front view thereof;

FIG. 4 is a rear view thereof;

FIG. 5 is a right side view thereof, a left side view being symmetrical to the right side view;

FIG. 6 is a plan view thereof; and,

FIG. 7 is a bottom view thereof.

The regular dashed lines represent unclaimed portions of the expansion valve and form no part of the claimed design.

The short/long dashed lines represent the boundary between claimed and unclaimed portions of the expansion valve. None of the broken lines form a part of the claimed design.

1 Claim, 6 Drawing Sheets

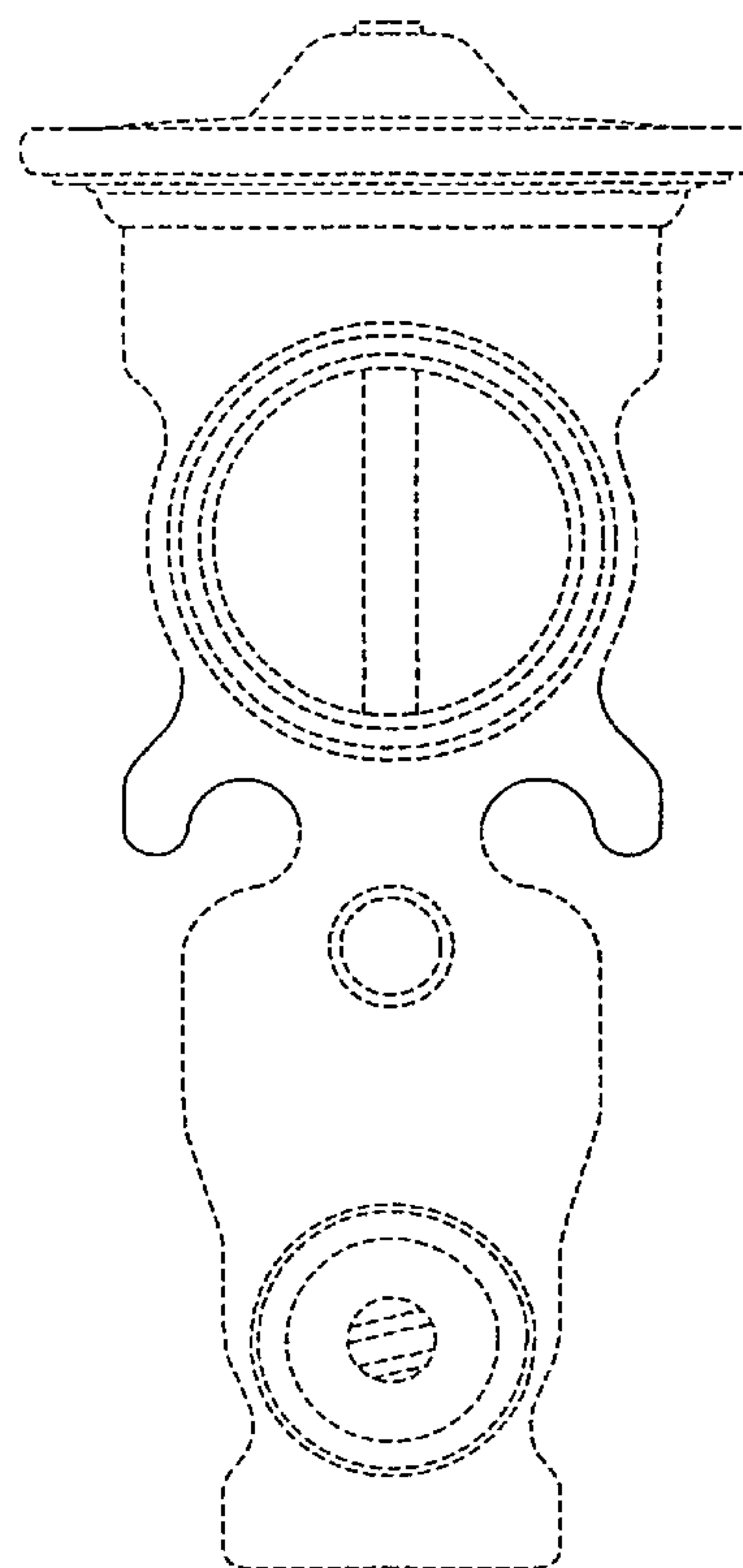
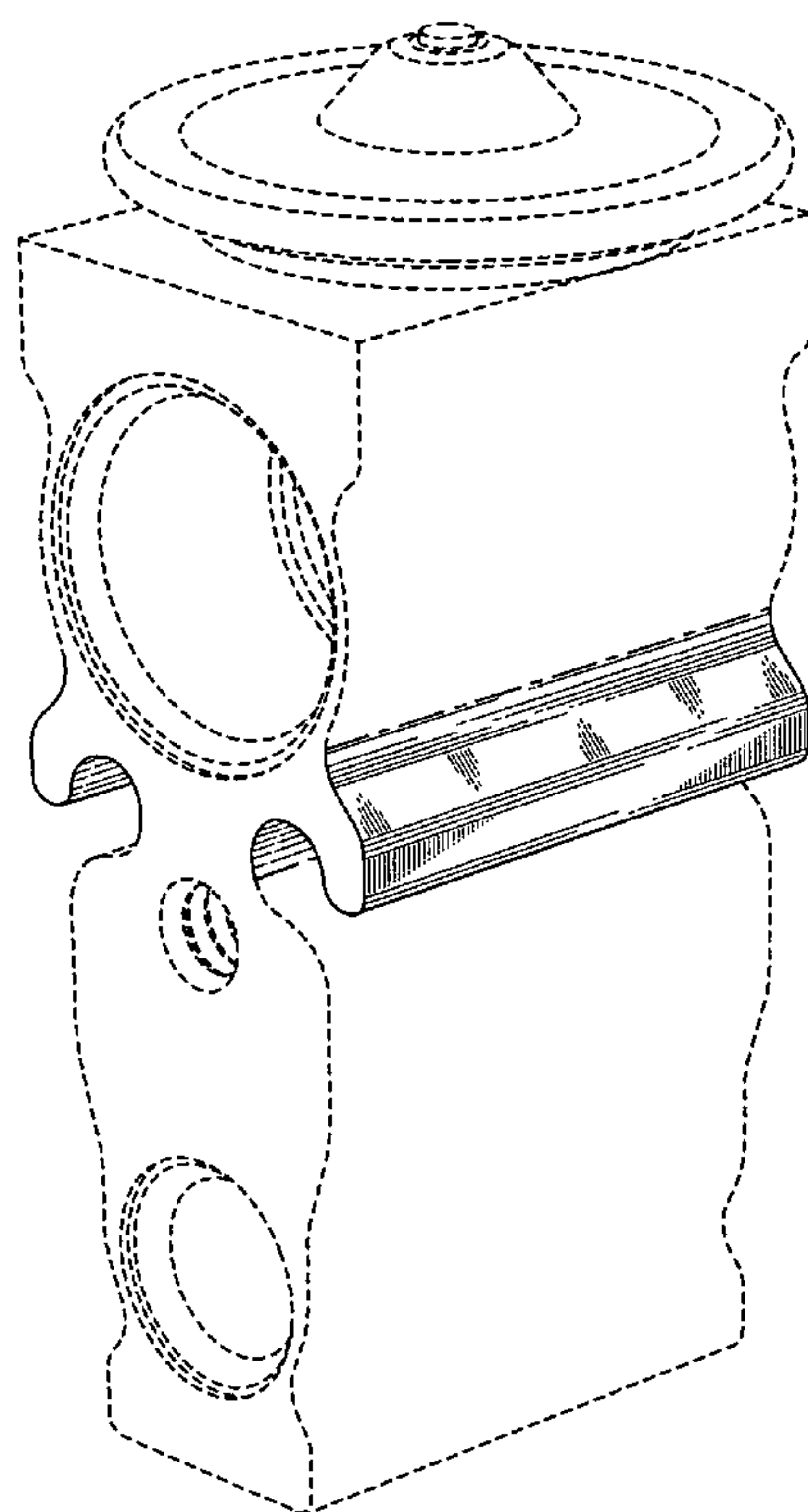

FIG. 1

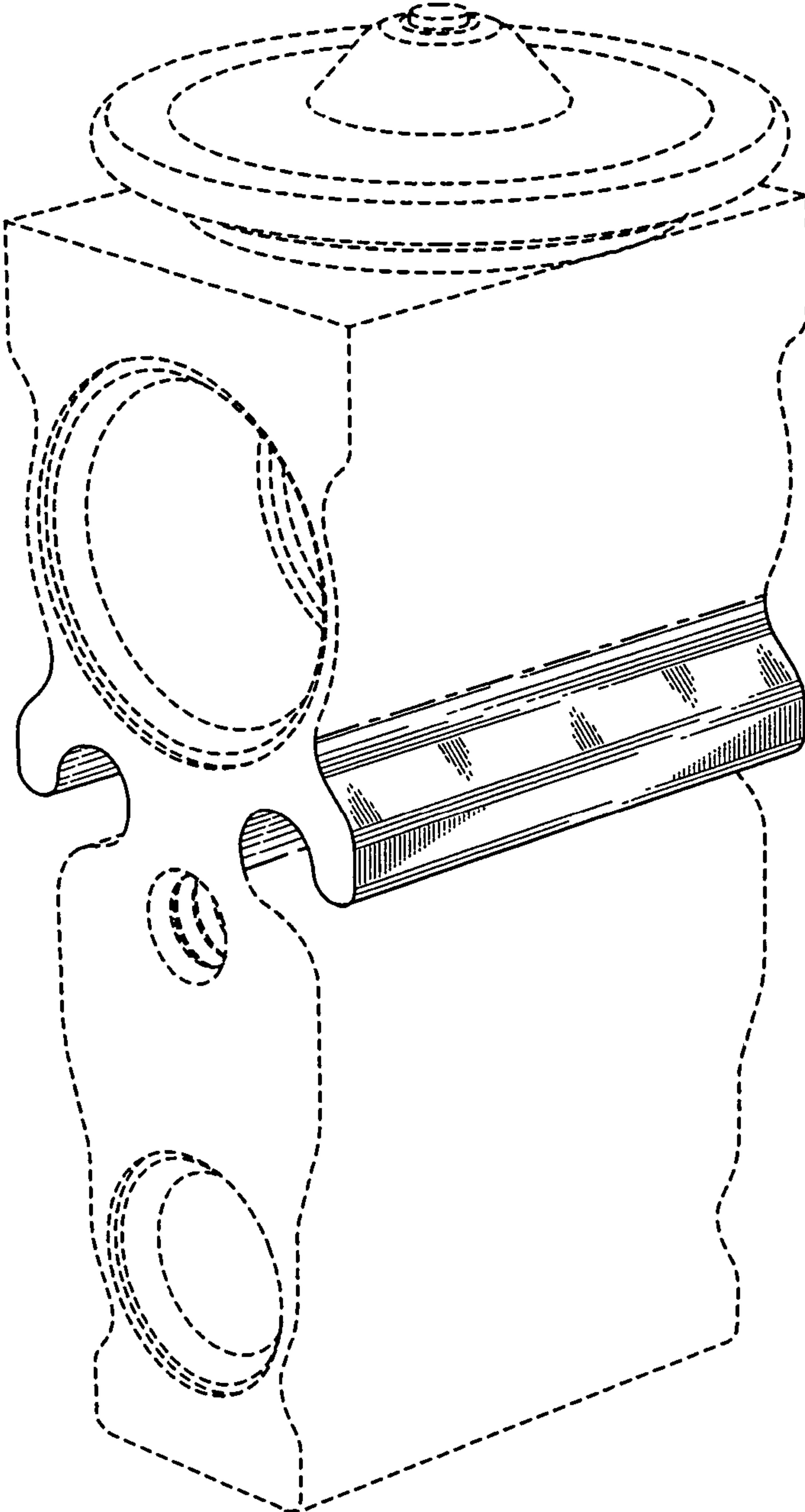

FIG. 2

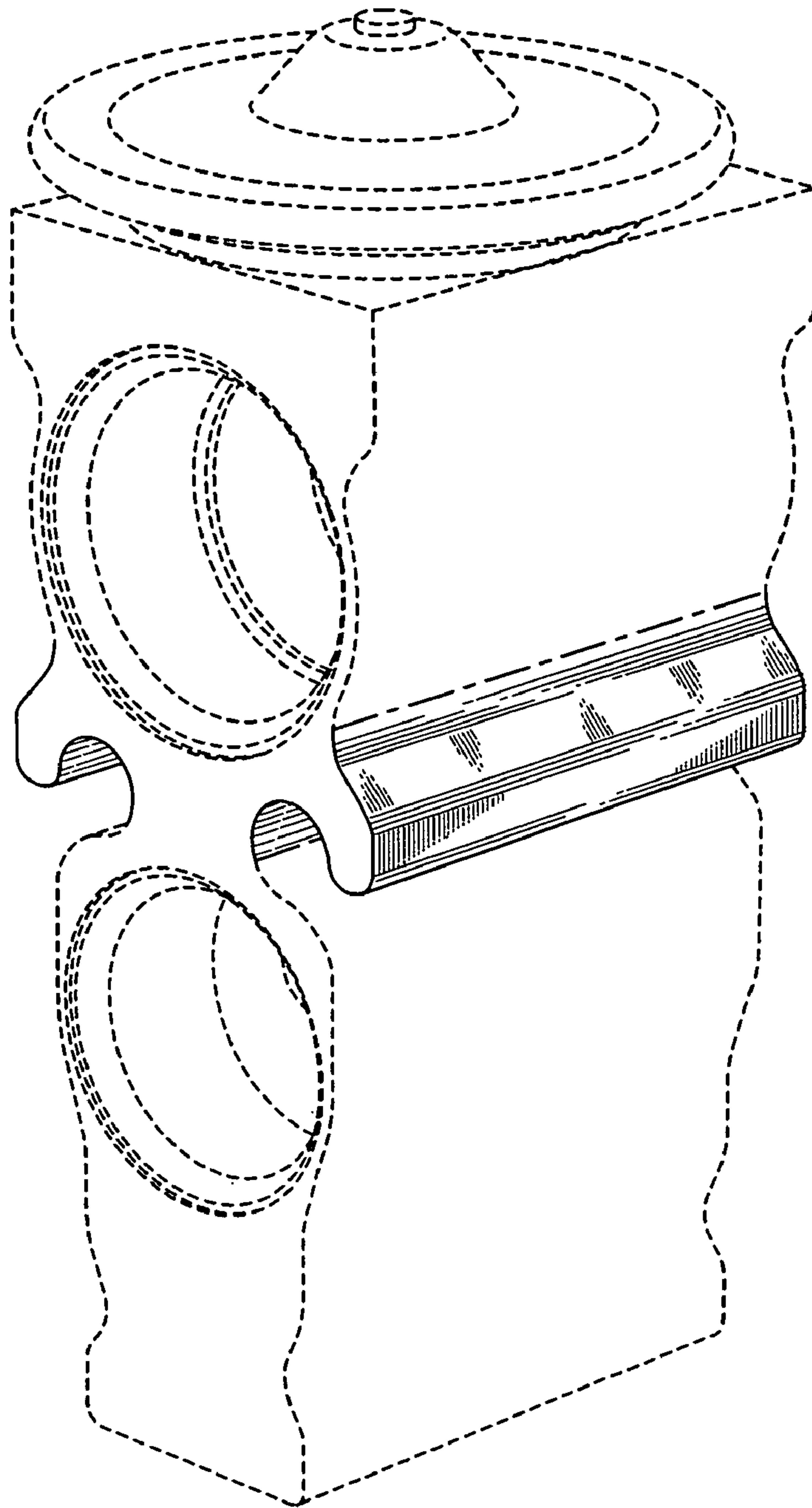

FIG. 3

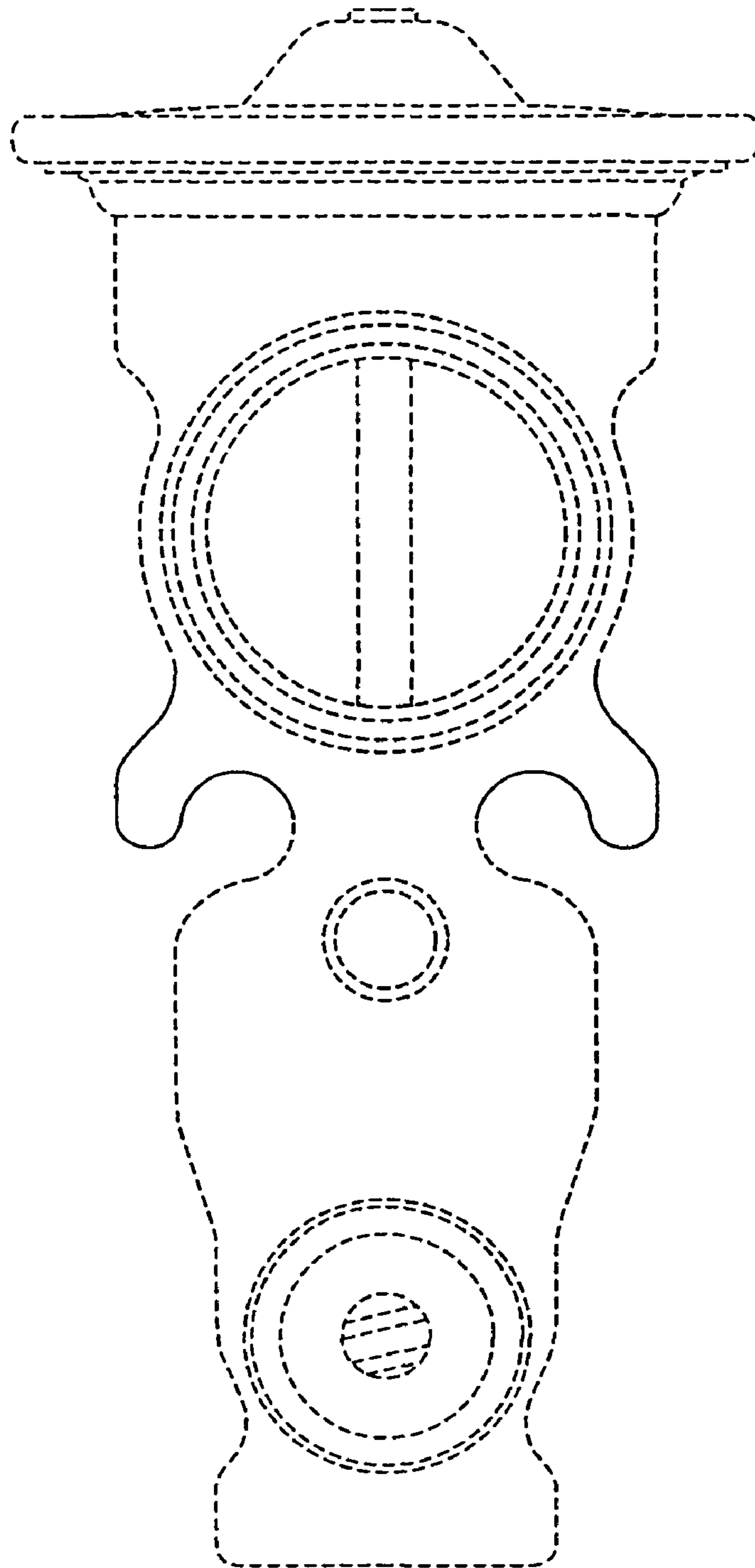

FIG. 4

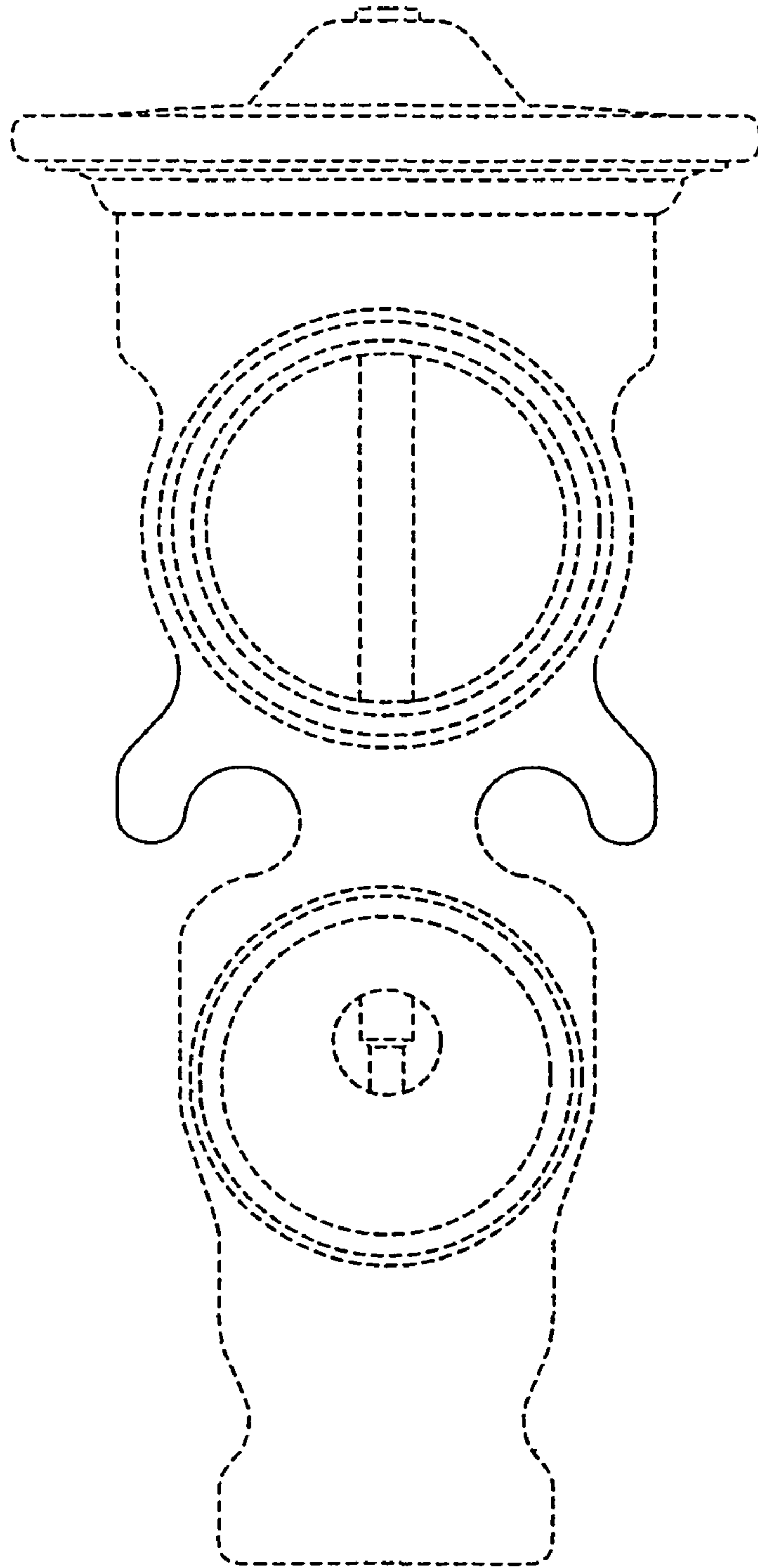

FIG. 5

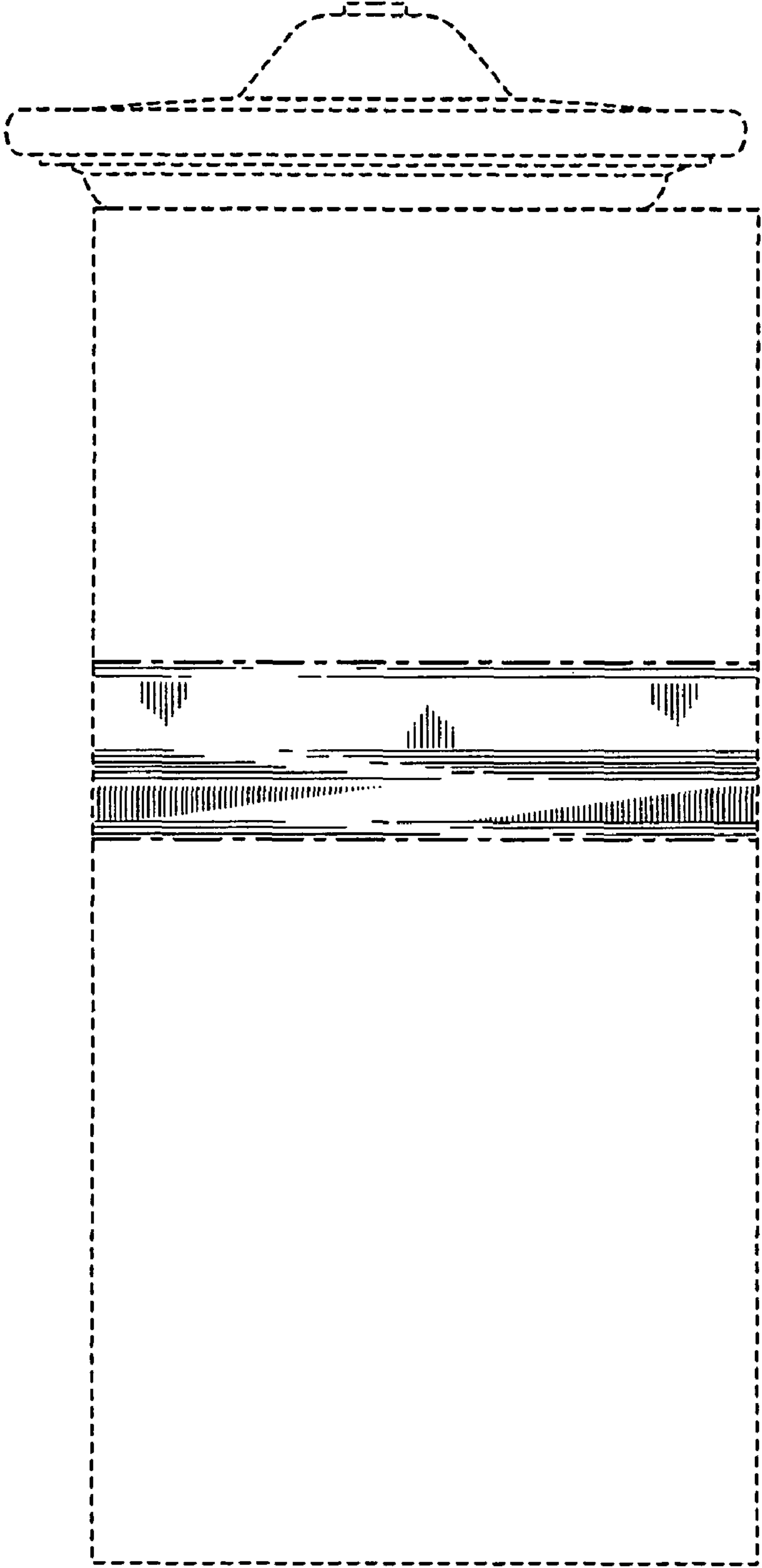

FIG. 6

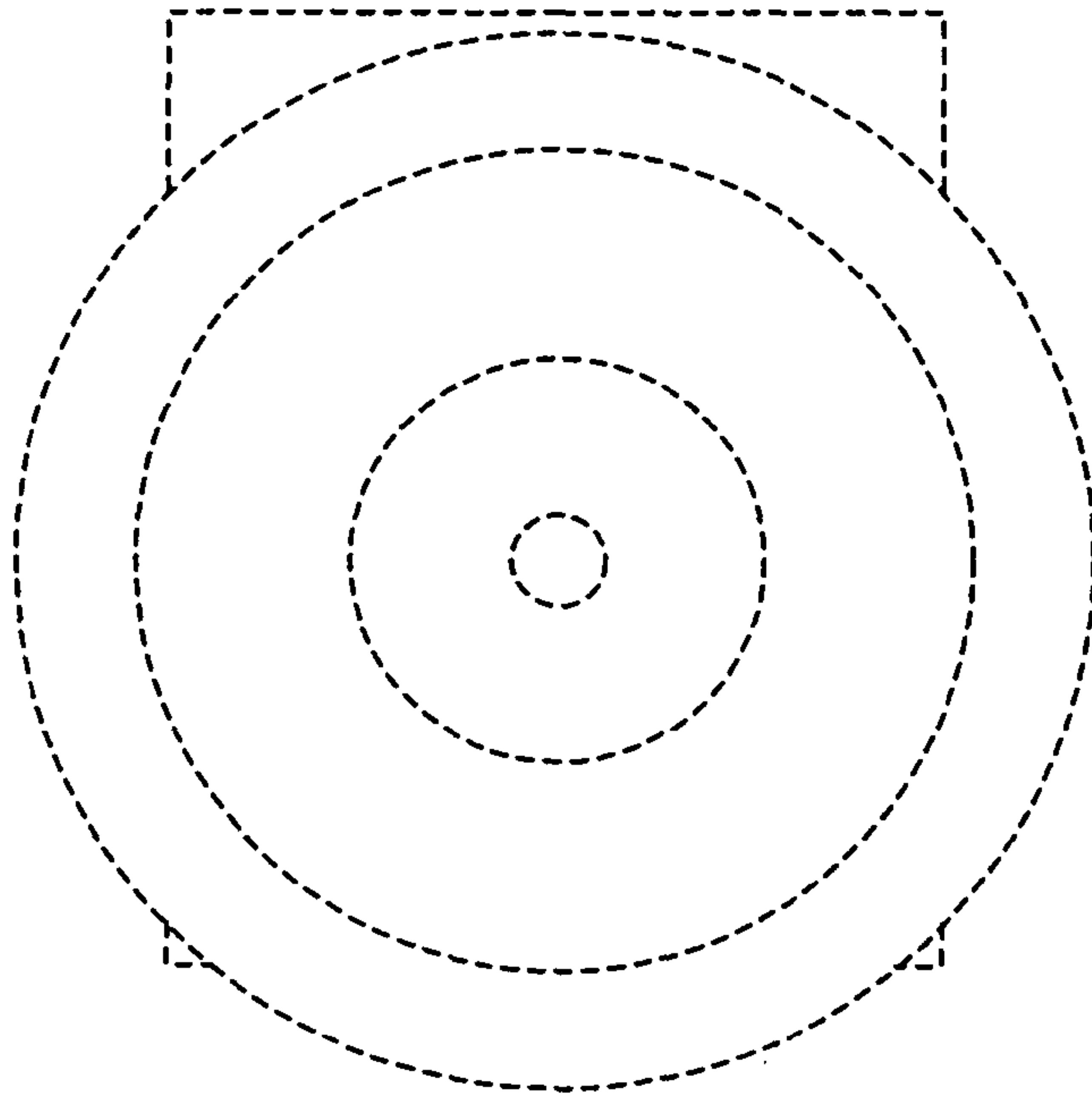

FIG. 7

